



Live Version 8.0.1 for Windows and Mac OS
April, 2009

Created by Bernd Roggendorf, Gerhard Behles, Robert Henke, Awi, Reiner Rudolph, Stefan Haller, Stefan Franke, Frank Hoffmann, Andreas Zapf, Ralf Suckow, Gregor Klinke, Matthias Mayrock, Friedemann Schautz, Ingo Koehne, Jakob Rang, Pablo Sara, Nicholas Allen, Henrik Lafrenz, Jan Buchholz, Kevin Haywood, Dominik Wilms, Christian Kleine, Amaury Groc, Daniel Büttner, Alex Koch, Henrik Hahn, Simon Frontzek, Torsten Wendland, Torsten Slama, Eduard Müller, Jeremy Bernstein, Bernard Chavonnet, Carl Seleborg, Claes Johanson, Bernhard Bockelbrink, Nico Starke, Jörg Klußmann, Stefan Brunner, Tobias Hahn, Stefan von der Mark, Carsten Henßinger, Stephan Diehl, David Talbot, Robert Feldbinder, Diez Roggisch, Justine Lera, Dennis DeSantis, Ian Gallagher, Philipp Gries, Marie Hoffmann, Marian Kalus, Stephan Krohn, Michael Dühr, Dennis Fischer.

Reference Manual by Dennis DeSantis, Ian Gallagher, Kevin Haywood, Rose Knudsen, Gerhard Behles, Jakob Rang, Robert Henke, Torsten Slama.

Content provided by:

SONiVOX – www.sonivoxrocks.com

Chocolate Audio – www.chocolateaudio.com

Puremagnetik – www.puremagnetik.com

Cycling '74 – www.cycling74.com

SonArte – www.sonarte.ca

e-instruments – www.e-instruments.com

Zero-G – www.zero-g.co.uk

Physical Modeling technology provided by:

Applied Acoustics Systems – www.applied-acoustics.com



Copyright 2009 Ableton AG. All rights reserved. Made in Germany.

This manual, as well as the software described in it, is furnished under license and may be used or copied only in accordance with the terms of such license. The content of this manual is furnished for informational use only, is subject to change without notice, and should not be construed as a commitment by Ableton. Every effort has been made to ensure that the information in this manual is accurate. Ableton assumes no responsibility or liability for any errors or inaccuracies that may appear in this book.

Except as permitted by such license, no part of this publication may be reproduced, edited, stored in a retrieval system or transmitted, in any form or by any means, electronic, mechanical, recording or otherwise, without the prior written permission of Ableton.

Ableton, the Ableton Logo, the Live logo are trademarks of Ableton AG. Apple, GarageBand, Mac, Macintosh, Mac OS and QuickTime are trademarks of Apple Inc, registered in the U.S. and other countries. Finder is a trademark of Apple Inc. Windows is a registered trademark of Microsoft Corporation in the United States and other countries. Intel is a registered trademark of Intel Corporation or its subsidiaries in the United States and other countries. SONiVOX is the brand name trademark of Sonic Network, Inc. VST and ASIO are trademarks and software of Steinberg Media Technologies GmbH. ReWire, Recycle and REX2 are trademarks of Propellerhead Software AB. All other product and company names are trademarks or registered trademarks of their respective holders.

Chapter 1

Welcome to Live

1.1 The Ableton Team Says: Thank You

Live is the result of musicians wanting a better way to create, produce and perform music using a computer. A great deal of effort has been put into making Live easy and fun to use, yet at the same time capable of helping you create music with unlimited depth and sophistication. This effort continues even as you read these lines... in fact, a new, improved Live version might already be available for download! Please check [on our website now¹](#), or choose the Check for Updates command from the Help menu.

We hope you enjoy using Live and that it enhances your creative process. Should you have suggestions about how we can improve Live, please [let us know²](mailto:contact@ableton.com).

Your Ableton Team.

¹<http://www.ableton.com/downloads>

²contact@ableton.com

1.2 What's New in Live 8?

1.2.1 New Warping Engine

- Live's **warping engine** has been dramatically overhauled, with more accurate transient detection and a redesigned interface that allows you to drag the waveform along a fixed timeline.
- New transient loop and envelope controls in **Beats Mode** allow for higher quality warping, especially at slower tempos.
- New **Complex Pro Mode** for even higher quality warping.
- You can now **quantize audio clips** using the Edit menu's Quantize command.

1.2.2 New Groove Functionality

- **Groove patterns** can now modify the timing and volume of audio and MIDI clips in real-time. A large library of grooves is provided, and grooves can be extracted from clips and then reapplied to other clips.

1.2.3 Workflow Enhancements

- **Crossfades** are now available for adjacent clips in Arrangement View.
- The **MIDI Editor** has been reworked, and editing MIDI is now similar to editing in the Arrangement. An insert mark sets the precise location for clipboard operations, allowing notes or time to be copied, pasted, inserted and deleted anywhere in the clip. Enhanced keyboard commands also improve the editing workflow.
- As a result of the new navigation possibilities in the MIDI Editor, it is now possible to **step record** MIDI notes.
- Audio and MIDI tracks can be grouped into a summing **Group Track**. Group Tracks can be folded or unfolded to help organize your workflow in both Session and Arrangement View.

- Live's interface can be magnified to maximize visibility via the **Zoom Display** slider.
- A **Preview Tab** in the Browser provides a visual overview of the previewed file's contents, and allows you to scrub in the waveform or MIDI display.
- When multiple tracks are selected, adjusting one of their mixer or routing parameters will adjust the same parameter in the other selected tracks.

1.2.4 Ableton Effects and Instruments

- **Operator** has been dramatically overhauled with a variety of new filter types, an expanded set of modulation routings and additive wavetable synthesis with drawable partials.
- **Collision** optional add-on instrument
- **Corpus** optional add-on effect
- **Latin Percussion** optional add-on sample library
- **Looper** provides classic tape-loop style overdubbing, with drag-and-drop export to clips, MIDI-mappable controls optimized for use with foot pedals and more.
- **Vocoder** combines the best of classic analog vocoders with powerful new features.
- **Limiters** provides a true "brickwall" limiter, ideal for mastering applications.
- The **Multiband Dynamics** device allows for upward or downward compression or expansion of up to three separate frequency bands.
- **Overdrive** is a powerful addition to Live's arsenal of distortion tools.
- **Frequency Shifter** combines frequency shifting and ring modulation effects in a single device.

1.2.5 New Library

- Live's **Library** is now stocked with a large collection of new creative tools including numerous device presets, loops and samples, construction kits and template Sets.

1.2.6 Online Collaboration Tools

- **Share Live Sets with other users** via a shared web area at ableton.com.

1.2.7 Controllers

- Support for the **APC40** (Ableton Performance Controller), a dedicated controller for Ableton Live.

1.2.8 More Improvements

- **Macro Controls** now automatically show the name and units of their mapped parameter whenever possible.
- a High-Quality mode has been added to the **Flanger** effect.
- **Third-party plug-in support** has been improved to allow access to an arbitrary number of parameters.
- it is now possible to **slice** based on the transients of the audio file.
- the **Ping Pong Delay** and **Simple Delay** effects now have three user-selectable delay transition modes.
- **Sampler's** waveshaper now offers a fourth curve type: "4bit."
- Multiple Live Packs can be uninstalled simultaneously, and the Browser can now sort content by the Live Pack that installed it.

Chapter 2

First Steps

When you install Live and run it for the first time, you will be presented with an authorization dialog. Please see the chapter on [authorizing Live](#) should you have questions or concerns during the authorization process.

If you do not (yet) own Live, you can still try out all of Live's features, but you will not be able to save or export your work.

2.1 Learn About Live

Live comes with a set of interactive *lessons* to take you step by step through the key features of the program. The lessons are organized in a table of contents, which can be opened directly in the program via the Help menu. We highly recommend following the lessons. Many users have told us that the lessons helped them become familiar with the program very quickly.

We also recommend that you read the [Live Concepts chapter](#), which encapsulates everything that Live is and can do, and is therefore a worthwhile read for both beginners and experienced users. The remaining chapters of this manual serve as in-depth reference for the material introduced in Live Concepts.

2.1.1 Using the Info View and Index

Live's Info View tells you the name and function of whatever you place the mouse over. For certain items, you can create your own text and it will appear in this window.

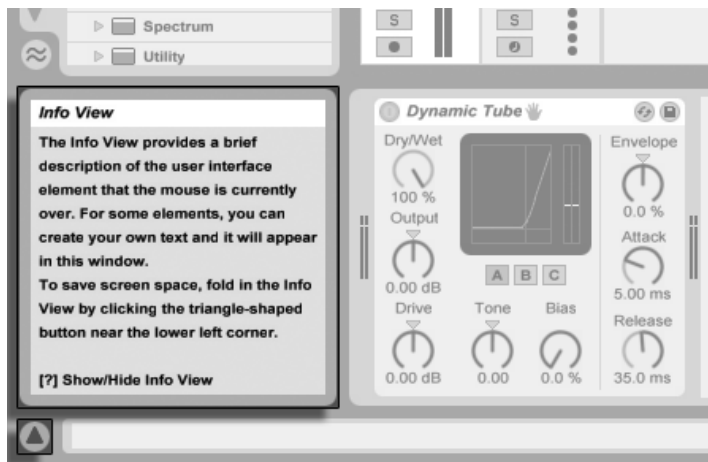

The Info View and its Show/Hide Button.

If you require more information on a specific user interface element or topic, please consult this reference manual. The index, found at the end of the manual, contains the names of all user interface elements and will lead you to the relevant section.

2.2 Setting up Preferences

Live's Preferences window is where you can find various settings that determine how Live looks, behaves and interfaces with the outside world. This window is accessed from the Preferences command, which in Windows is available in the Options menu and in OS X is available in the Live menu. Preferences can also be accessed with the **Ctrl** + **P** (PC) / **Cmd** + **P** (Mac) shortcut.

Live's Preferences are distributed over several tabs:

- In the Look/Feel tab, you can modify various settings, including the language used for

text display and the color scheme, or “skin,” for the Live user interface. This is also where you can adjust the size of objects displayed on the screen: the Zoom Display slider allows you to zoom Live’s screen to any percentage between 50% and 200% of the standard interface size.

- The Audio Preferences are used to set up Live’s audio connections with the outside world via an audio interface. Please take the time to follow the program’s built-in “Setting up Audio I/O” lesson, which will walk you through all the steps required to set up and optimize the settings for any given system. To access the lesson, use the Lessons Table of Contents command from the Help menu.
- The MIDI/Sync Preferences are used to help Live recognize MIDI devices for three separate and distinct purposes:
 - *Playing MIDI notes.* To learn how to route an external device into Live for MIDI input, or how to send MIDI to an external device, please see the [Routing and I/O chapter](#).
 - *Controlling parts of the interface remotely.* This subject is covered in detail in the [MIDI and Key Remote Control chapter](#).
 - *Syncing the program* with an external sequencer or drum machine, either as a master or a slave. Please see the [Synchronizing via MIDI chapter](#) for details.
- The File/Folder Preferences pertain to Live’s [file management](#) and the location of [plug-in devices](#).
- The Record/Warp/Launch Preferences allow customizing the default state for [new Live Sets](#) and [their components](#), as well as selecting options for [new recordings](#).
- The CPU Preferences include options for managing the [processing load](#), including multicore/multiprocessor support.
- The User Account/Licenses Preferences are used to manage licensing and installation of [the Live platform](#), and add-on components like [the Operator instrument](#).
- The Library Preferences allow you to specify the location of Live’s [Library](#) and manage currently installed Live Packs.

2.3 The Main Live Screen

Most of your work in Live happens in the main Live screen. This screen consists of a number of views, and each view manages a specific aspect of your *Live Set*, which is the type of document that you create and work on in Live. Since screen space is usually limited, the Live views can't all be displayed at the same time.

Each one of the *selector buttons* at the screen borders calls up a specific view; clicking this one, for instance, opens Live's *Device Browser*:

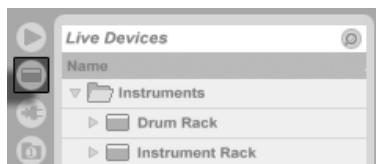

The Device Browser Selector.

To hide one of Live's views and free up screen space, click on the triangle-shaped button next to it. To restore the view, click the button again.



A View Show/Hide Button.

You can run Live in Full Screen Mode by selecting the Full Screen command from the View menu. To leave Full Screen Mode, click the button that appears in the lower right corner of the screen. Full Screen Mode can also be toggled by pressing **F11**. (Note: On Mac OS X, this key is assigned by default to Exposé, and will not toggle Full Screen Mode unless Exposé has been deactivated or assigned to a different key in OS X's System Preferences.)

If one of the browser views is open, you can adjust the main window's horizontal split by dragging.

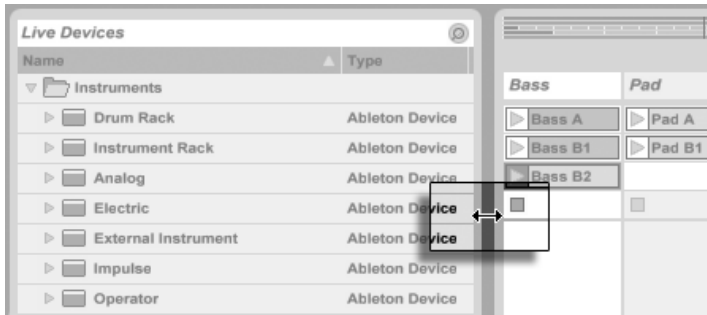

Adjusting the Main Window Split.

Chapter 3

Authorizing Live

Live is protected against illegal use by a copy protection scheme. This scheme has been designed to meet the highest security standards while avoiding hassles for our customers. If you find this procedure to be an inconvenience, please understand that the copy protection secures your investment: It allows Ableton to provide you with support and to continue developing Live.

Please be aware that the standard Live license grants you the right to use Live on *only one computer at a time*. You can, however, authorize Live more than once under the legal and technical conditions described [later](#).

The first time you run Live, you will be prompted to complete the authorization process. The software will walk you through the steps.

If the computer that you wish to authorize is connected to the internet, you can authorize immediately by pressing the appropriate button in the dialog box. If you do not have an internet connection, press the "No internet on this computer" button and follow the instructions.

3.1 Copy Protection FAQs

3.1.1 Can I Use Live or Other Ableton Products Without a Serial Number?

If you do not (yet) own Live or its add-on products, you can still try them out, but saving and exporting will be disabled.

If trying Live or another product raises your interest in purchasing it, please visit [the Ableton webshop](#)¹. This site contains information about Ableton's distributor and dealer network. It also offers you the opportunity to buy Ableton products online.

3.1.2 What if I Change My Computer's Components?

If you change your computer components for some reason, Live may indeed ask you to authorize the software [another time](#). Live does not need to be reauthorized when computer peripherals are replaced (audio or MIDI hardware, printers, modems). But you may need to authorize again if the motherboard, processor or network card is replaced. On some computers, reformatting a hard drive will require a new authorization.

3.1.3 Can I Authorize Live More than Once?

The standard Live license allows you to use Live on *only one computer at a time*. However, the Ableton server will provide you with two authorizations in good faith that you will use Live on only one machine at a time.

You can therefore run Live on both a studio desktop computer and a tour laptop, but not at the same time.

Should the Ableton server reject your demand for another authorization, please contact [Ableton's technical support](#)².

¹<http://www.ableton.com/shop>

²<http://www.ableton.com/support>

To use Live on more than one computer at a time, you may require a *secondary license* or a *site license*. Ableton offers these licenses at special rates.

3.1.4 Can I Play my Set from a Computer That Is Not Authorized?

Even if Live is not authorized, you can still load and perform a Live Set with no time limitation. You cannot, however, save or export your work. When you go on tour, consider taking along your Live program CD and a CD with the last state of your Live Set(s). In case of an emergency, you can install and run Live on any computer available and play your backup Live Set(s).

3.1.5 What Do I Do About Problems or Questions Regarding Copy Protection?

Please visit Ableton's [technical support page](http://www.ableton.com/support)³.

³<http://www.ableton.com/support>

Chapter 4

Live Concepts

This chapter introduces the essential concepts of Live. We advise you to read this chapter early in your Live career, as a solid understanding of the program's basic principles will help you fully exploit Live's potential for your music-making.

4.1 Live Sets

The type of document that you create and work on in Live is called a *Live Set*. Live Sets reside in a Live Project – a folder that collects related materials – and can be opened either through the File menu's Open command or via the built-in *File Browsers*.

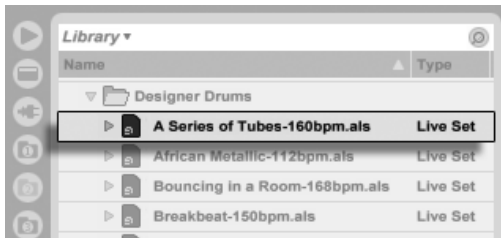

A Live Set in the File Browser.

Selecting the Library bookmark in Live's File Browser will take you to the Live Library of creative tools. Depending on what content you have installed, there may be a number of demo Sets here, and double-clicking a Live Set's name in the Browser will open that Live Set. You can also find Live Sets made by others at the Ableton website, as well as upload your own. This makes it easy to [collaborate with other Live users](#).

4.2 Arrangement and Session

The basic musical building blocks of Live are called *clips*. A clip is a piece of musical material: a melody, a drum pattern, a bassline or a complete song. Live allows you to record and alter clips, and to create larger musical structures from them: songs, scores, remixes, DJ sets or stage shows.

A Live Set consists of two environments that can hold clips: The *Arrangement* is a layout of clips along a musical timeline; the *Session* is a real-time-oriented "launching base" for clips. Every Session clip has its own play button that allows launching the clip at any time and in any order. Each clip's behavior upon launch can be [precisely specified through a number of settings](#).

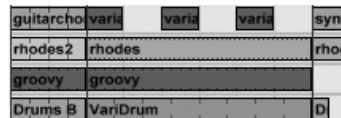

Clips in the Session View (Left) and in the Arrangement View (Right).

The Arrangement is accessed via the [Arrangement View](#) and the Session via the [Session View](#); you can toggle between the two views using the computer's Tab key or their respective selectors. Because the two views have distinct applications, they each hold individual collections of clips. However, it is important to understand that flipping the views simply changes the appearance of the Live Set and does not switch modes, alter what you hear or change what is stored.



The Arrangement and Session View Selectors.

The Arrangement View and the Session View interact in useful (though potentially confusing) ways. One can, for instance, improvise with Session clips and **record a log of the improvisation** into the Arrangement for further refinement. This works because Arrangement and Session are connected via *tracks*.

4.3 Tracks

Tracks host clips and also manage the flow of signals, as well as the creation of new clips through recording, sound synthesis, effects processing and mixing.

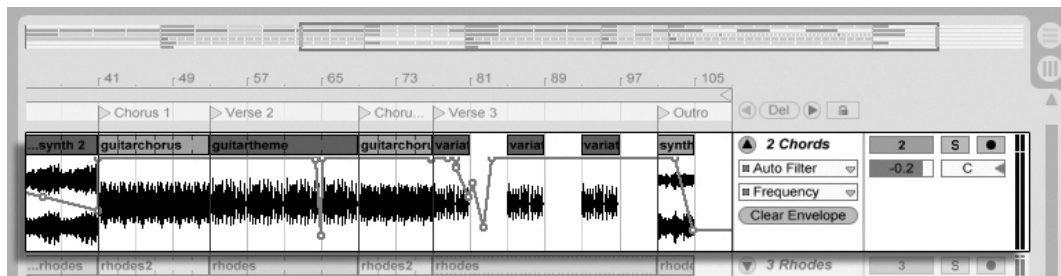

A Track in the Arrangement View.

The Session and Arrangement share the same set of tracks. In the Session View, the tracks are laid out vertically from left to right, while in the Arrangement View they are horizontal from top to bottom. A simple rule governs the cohabitation of clips in a track:

A track can only play one clip at a time.

Therefore, one usually puts clips that should play alternatively in the same Session View column, and spreads out clips that should play together across tracks in rows, or what we call **scenes**.

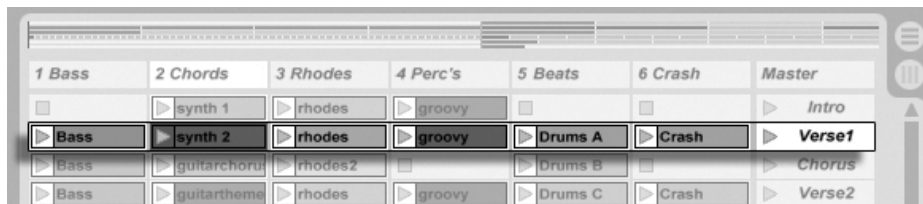

A Scene in the Session View.

The exclusivity of clips in a track also implies that, at any one time, a track will either play a Session clip or an Arrangement clip, but never both. So, who wins? When a Session clip is launched, the respective track stops whatever it is doing to play that clip. In particular, if the track was playing an Arrangement clip, it will stop it in favor of the Session clip – even as the other tracks continue to play what is in the Arrangement. The track will not resume Arrangement playback until explicitly told to do so.



The Back to Arrangement Button.

This is what the *Back to Arrangement* button, found in the *Control Bar* at the top of the Live screen, is for. This button lights up to indicate that one or more tracks are currently *not* playing the Arrangement, but are playing a clip from the Session instead.

We can click this button to make all tracks go back to the Arrangement. Or, if we like what we hear, we can capture the current state into the Arrangement by activating the *Record* button. Disengaging Record Mode or stopping Live using the *Stop* button leaves us with an altered Arrangement.

4.4 Audio and MIDI

Clips represent recorded signals. Live deals with two types of signals: audio and MIDI. In the digital world, an audio signal is a series of numbers that approximates a continuous signal as generated by a microphone or delivered to a loudspeaker. A MIDI signal is a sequence of commands, such as “now play a C4 at mezzo piano.” MIDI is a symbolic representation of musical material, one that is closer to a written score than to an audio recording. MIDI

signals are generated by input devices such as MIDI or USB keyboards¹.

It takes an *instrument* to convert MIDI signals into audio signals that can actually be heard. Some instruments, such as Live's *Simpler*, are for chromatic playing of one sound via the keyboard. Other instruments, such as Live's *Impulse*, have a different percussion sound assigned to each keyboard key.

Audio signals are recorded and played back using *audio tracks*, and MIDI signals are recorded and played back using *MIDI tracks*. The two track types have their own corresponding clip types. Audio clips cannot live on MIDI tracks and vice versa.

Information about inserting, reordering and deleting audio and MIDI tracks is found [here](#).

4.5 Audio Clips and Samples

An audio clip contains a reference to a *sample* (also known as a “sound file” or “audio file”) or a *compressed sample* (such as an MP3 file). The clip tells Live where on the computer's drives to find the sample, what part of the sample to play and *how* to play it.

When a sample is dragged in from one of Live's built-in *File Browsers*, Live automatically creates a clip to play that sample. Prior to dragging in a sample, one can audition or *preview* it directly in the Browser; the switch in the Browser with the headphone icon activates previewing.

¹For an introduction to digital audio and MIDI, please see <http://img.uoregon.edu/emi/emi.php> and <http://www.midi.org/>

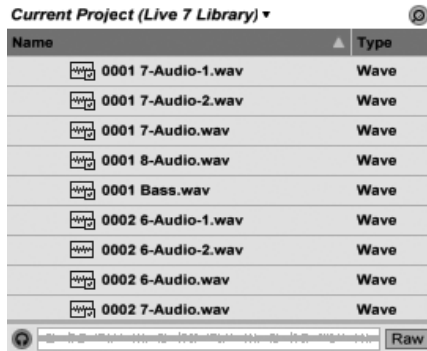

Samples Are Dragged in from Live's File Browsers.

Live offers many options for playing samples in exciting new ways, allowing you to create an abundance of new sounds without actually changing the original sample – all the changes are computed in real time, while the sample is played. The respective settings are made in the *Clip View*, which appears on screen when a clip is double-clicked.

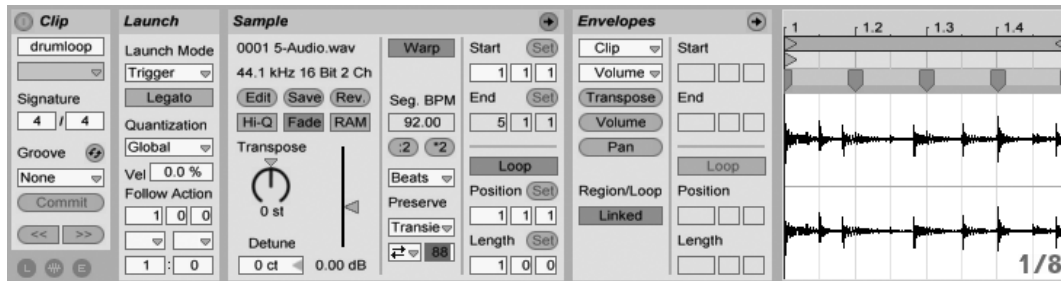

An Audio Clip's Properties as Displayed in the Clip View.

Many powerful manipulations arise from Live's *warping* capabilities. Warping means changing the speed of sample playback independently from the pitch so as to match the song tempo. The tempo can be adjusted on the fly in the Control Bar's Tempo field.



The Control Bar's Tempo Field.

The most elementary use of this technique, and one that usually requires no manual setup, is synchronizing sample loops to the chosen tempo. Live's Auto-Warp algorithm actually makes it easy to line up any sample with the song tempo, such as a recording of a drunken jazz band's performance. It is also possible to radically change the sonic signature of a

sound using extreme warp settings.

4.6 MIDI Clips and MIDI Files

A MIDI clip contains musical material in the form of MIDI notes and controller envelopes. When MIDI is imported from a *MIDI file*, the data gets incorporated into the Live Set, and the original file is not referenced thereafter. In the Live File Browsers, a MIDI file appears as a folder that can be opened to reveal its individual component tracks, which can be selectively dragged into the Live Set.

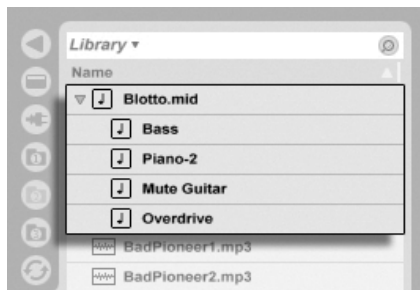

MIDI Files Are Dragged in from Live's File Browsers.

As you'd expect, a MIDI clip's contents can be *accessed and edited* via the *Clip View*, for instance to change a melody or "paint" a drum pattern.



A MIDI Clip's Properties as Displayed in the Clip View.

4.7 Devices and the Mixer

A track can have not only clips but also a chain of *devices* for processing signals. Double-clicking a track's title bar brings up the *Track View*, which shows the track's device chain.

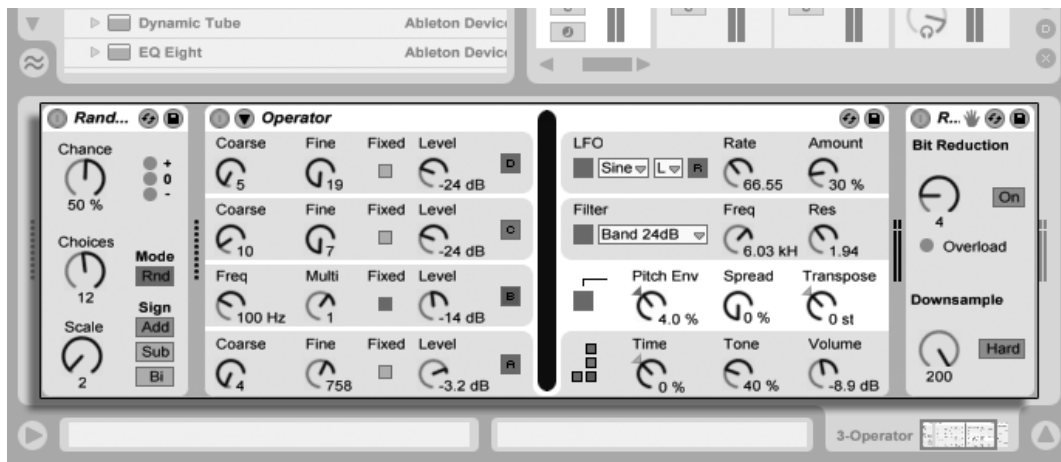

The Track View
Displaying a MIDI Track's
Device Chain.

Live's built-in *audio effects*, *MIDI effects* and *instruments* are available from the *Device Browser* and can be added to tracks by dragging them from there into the *Track View*, or into a *Session* or *Arrangement* track.



Live's Built-in Devices Are Available from the Device Browser.

You can also use **plug-in devices** in Live. VST and Audio Units (Mac OS X only) Plug-ins are available from the Plug-In Device Browser.

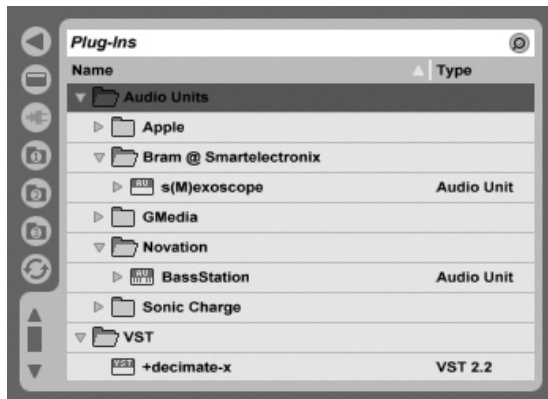

Plug-In Devices Are Available from the Plug-In Device Browser.

Consider an audio clip playing in an audio track. The audio signal from the clip reaches the leftmost device in the chain. This device processes (changes) the signal and feeds the result into the next device, and so on. The number of devices per track is theoretically unlimited. In practice, the computer's processor speed does impose a limit on the number of devices

you can use at the same time, a topic that deserves [separate discussion](#). Note that the signal connections between audio devices are always stereo, but the software's inputs and outputs can be configured to be mono in the Audio Preferences.

When the signal has passed through the device chain, it ends up in Live's [mixer](#). As the Session and Arrangement share the same set of tracks, they also share the mixer. The mixer can be shown in both views for convenience. To optimize the screen layout, the individual mixer sections can be shown or hidden using the View menu's entries.

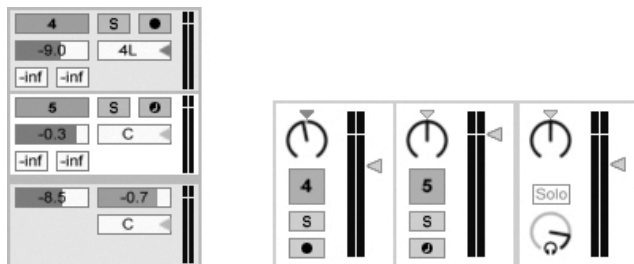

The Live Mixer in the Arrangement View (Left) and Session View (Right).

The mixer has controls for volume, pan position and *sends*, which adjust the contribution each track makes to the input of any *return tracks*. Return tracks only host effects, and not clips. Via their sends, all tracks can feed a part of their signal into a return track and share its effects.

The mixer also includes a [crossfader](#), which can create smooth transitions between clips playing on different tracks. Live's crossfader works like a typical DJ mixer crossfader, except that it allows crossfading not only two but any number of tracks – including the returns.

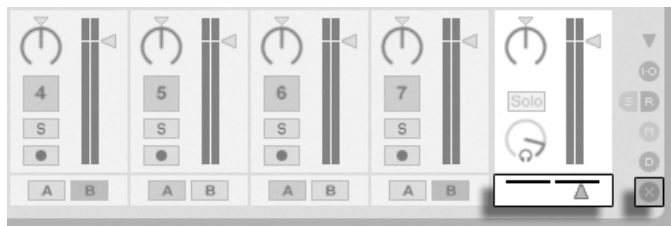

Live's Crossfader.

Devices that receive and deliver audio signals are called *audio effects*. Audio effects are the only type of device that fit in an audio track or a return track. However, two more types of devices are available for use in MIDI tracks: *MIDI effects* and *instruments*.

Consider a MIDI track playing a clip. The MIDI signal from the clip is fed into the track's device chain. There, it is first processed by any number of MIDI effects. A MIDI effect receives and delivers MIDI signals. One example is the Scale effect, which maps the incoming notes onto a user-defined musical scale. The last MIDI effect in the chain is followed by an instrument. Instruments, for instance Live's *Simpler* and *Impulse*, receive MIDI and deliver audio. Following the instrument, there can be any number of audio effects – as in an audio track.

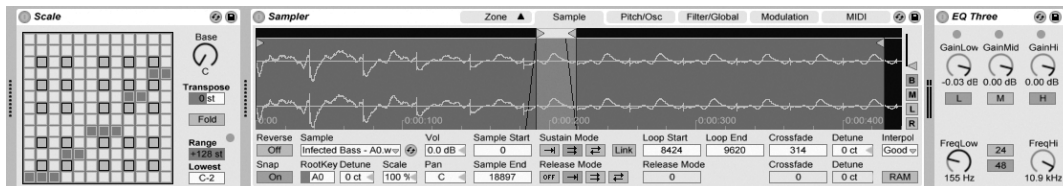

A MIDI Effect, an Instrument and an Audio Effect in a MIDI Track.

If a MIDI track has no instrument (and no audio effects), then the track's output is a plain MIDI signal, which has to be sent somewhere else to be converted into audio. In this case, the track's mix and Send controls disappear from the mixer.

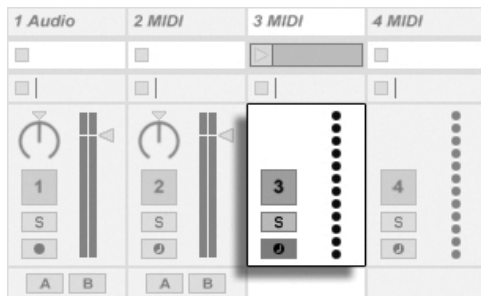

The Mixer for a MIDI Track without an Instrument.

4.8 Presets and Racks

Every Live device can store and retrieve particular sets of parameter values as *presets*. As presets are stored independently from Live Sets, new presets become part of a library that any project can draw from.

Live's *Instrument*, *Drum and Effect Racks* allow saving combinations of devices and their

settings as a single preset. This feature allows for the creation of powerful multi-device creations and effectively adds all the capabilities of Live's MIDI and audio effects to the built-in instruments.

4.9 Routing

As we have seen, all tracks deliver signals, either audio or MIDI. Where do these signals go? This is set up in the mixer's *In/Out* section, which offers, for every track, choosers to select a signal source and destination. The In/Out section, accessible through the View menu's In/Out option, is Live's "patchbay." Its **routing options** enable valuable creative and technical methods such as resampling, submixing, layering of synths, complex effects setups and more.



Track Routing Is Set up Using the In/Out Section in the Arrangement (Left) or Session View (Right).

Signals from the tracks can be sent to the outside world via the computer's audio and MIDI interfaces, to other programs that are connected to Live via **ReWire** or to other tracks or devices within Live. Tracks can also be combined into a **Group Track** which serves as a submixer for the selected tracks.

Likewise, a track can be set up to receive an input signal to be played through the track's devices. Again, tracks can receive their input from the outside, from a ReWire program or from another track or device in Live. The *Monitor* controls regulate the conditions under which the input signal is heard through the track.

It is also possible to route signals to external hardware devices from within a track's device chain, by using the **External Audio Effect** and **External Instrument** devices.

4.10 Recording New Clips

Audio tracks and MIDI tracks can record their input signal and thereby **create new clips**. Recording is enabled on a track by pressing its *Arm button*. With multiple tracks selected, pressing any of their Arm buttons will arm all of them. You can also hold down the **Ctrl** (PC) / **⌘** (Mac) modifier when clicking the Arm buttons to arm several tracks at once. If the Exclusive Arm option is enabled in the Record Preferences, inserting an instrument into a new or empty MIDI track will automatically arm the track. When the Control Bar's Record button is on, every armed track records its input signal into the Arrangement. Every take yields a new clip per track.

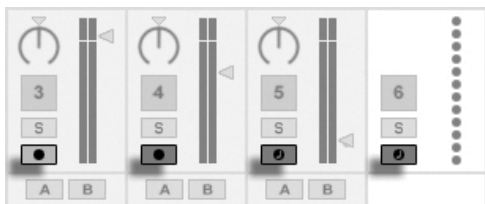

Track Arm Buttons, as They Appear in the Session View.

It is also possible to **record into Session View slots on the fly**. This technique is very useful for the jamming musician, as Session recording does not require stopping the music. When a track is armed, its Session slots exhibit Clip Record buttons, and clicking one of these commences recording. Clicking the Clip Record button again defines the end of the recording and launches the new clip. As these actions are subject to real-time *launch quantization*, the resulting clips can be automatically cut to the beat.



The Control Bar's Quantization Chooser.

Session recording in conjunction with the *Overdub* option and *Record Quantization* is the method of choice for creating drum patterns, which are built up by successively adding notes to the pattern while it plays in a loop. It only takes a MIDI keyboard (or the computer keyboard) and a MIDI track with Live's Impulse percussion instrument **to do this**.

4.11 Automation Envelopes

Often, when working with Live's mixer and effects, you will want the controls' movements to become part of the Arrangement. The movement of a control across the Arrangement timeline is called *automation*; a control whose value changes in the course of this timeline is *automated*. Automation is represented in the Arrangement View by *breakpoint envelopes*, which can be edited and drawn.

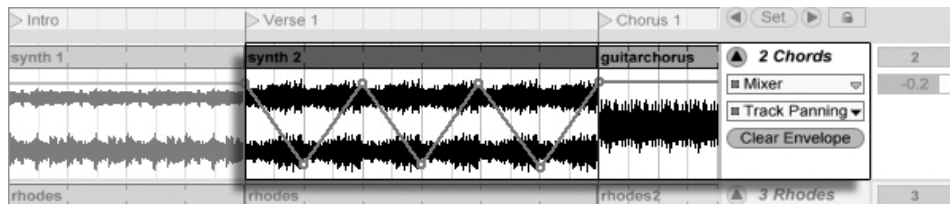

The Automated Pan Control and its Envelope.

Practically all mixer and effect controls in Live can be automated, even the song tempo. Creating automation is straightforward: All changes of a control that occur while the Control Bar's Record switch is on become automation.

Changing an automated control's value while *not* in Record Mode is similar to launching a Session clip while the Arrangement is playing: It deactivates the control's automation (in favor of the new control setting). The control will stop tracking its automation and rest with the new value until the Back to Arrangement button is pressed, which will resume Arrangement playback.

4.12 Clip Envelopes

Envelopes are found not only in tracks but also in clips. *Clip envelopes* are used to *modulate* device and mixer controls. Audio clips have, in addition, clip envelopes to influence the clip's pitch, volume and more; these can be used to change the melody and rhythm of recorded audio. MIDI clips have additional clip envelopes to represent MIDI controller data. Clip envelopes can be *unlinked* from the clip to give them independent loop settings, so that larger movements (like fade-outs) or smaller gestures (like an arpeggio) can be superimposed onto the clip's material.

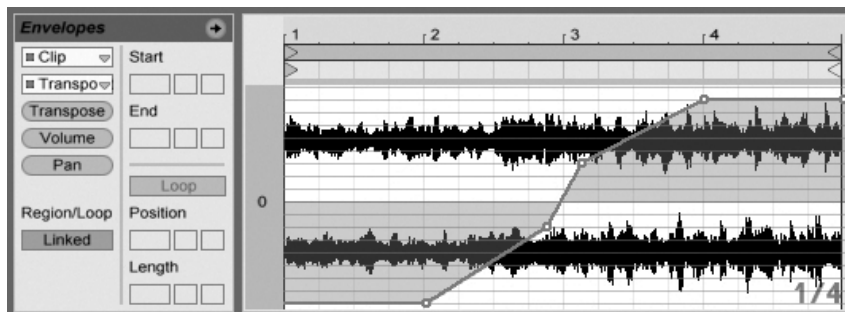

An Envelope for Clip Transposition.

4.13 MIDI and Key Remote

To liberate the musician from the mouse, most of Live's controls can be "remote-controlled" via an external MIDI controller. Remote mappings are established in *MIDI Map Mode*, which is engaged by pressing the MIDI switch in the Control Bar.

In this mode, you can click on any mixer or effect control, and then assign it to a controller simply by sending the desired MIDI message (for example, by turning a knob on your MIDI control box). Your assignments take effect immediately after you leave MIDI Map Mode. Session clips can be mapped to a MIDI key or even a keyboard range for chromatic playing.

MIDI keys and controllers that have been mapped to Live's controls are not available for recording via MIDI tracks. These messages are filtered out before the incoming MIDI is passed on to the MIDI tracks.



The Key/MIDI Map Controls.

Session clips, switches, buttons and radio buttons can be mapped to computer keyboard keys as well. This happens in *Key Map Mode*, which works just like MIDI Map Mode.

Live offers, in addition to this general purpose mapping technique, dedicated support for the *Akai APC40*, which allows for mouse-free operation of the program.

4.14 Saving and Exporting

Saving a Live Set saves everything it contains, including all clips, their positions and settings, and settings for devices and controls. An audio clip can, however, lose the reference to its corresponding sample if it is moved or deleted from disk. The links between samples and their clips can be preserved with a special command, **Collect and Save**, which makes a copy of each sample and stores it in a project folder along with the Live Set.

A separate Save button in the Clip View **saves a set of default clip settings** along with the sample, so that each time the sample is dragged into the program, it will automatically appear with these settings. This is especially useful if you have made warp settings for a clip and want to use it in multiple Live Sets.

Exporting audio from Live can be done from both the Session and Arrangement Views. Live will export the audio coming through on the Master output as an audio file of your specifications via **Export Audio/Video**.

Live can also **export individual MIDI clips as MIDI files**.

Exporting and saving material for later use in Live can be done very conveniently with the Live Clip format. Session View clips can be dragged back out of a Live Set to the File Browsers, and thereby **exported to disk as Live Clips**.

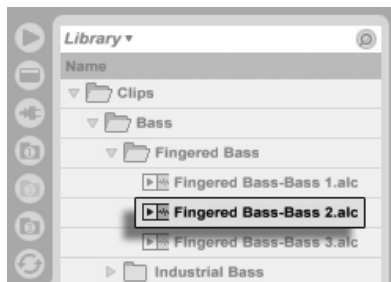

A Live Clip in the File Browser.

Live Clips are a very powerful way of storing ideas, as they save not only the clip's Clip View settings, but also the corresponding track's instruments and effects chain. Live Clips in the Browser can be previewed and added to any open Live Set just like sample files. In the Live Set, they restore the original clip's creative options.

Using Live Clips, you can build your own personalized library of:

- MIDI sequences with matching instruments and effects, e.g., a MIDI drum pattern with the associated Impulse and effects settings;
- Different **regions or loops** referencing the same source file;
- Variations of a sample loop created by applying **Warp Markers, clip envelopes and effects**;
- Ideas that may not fit your current project but could be useful in the future.

4.15 The Library

The **Live Library** acts as a repository of sounds that are available to all projects. In Live's File Browsers, the Library is accessible through a **bookmark**. Bookmarks can be selected by clicking the Browser's title bar to open the Bookmark menu:

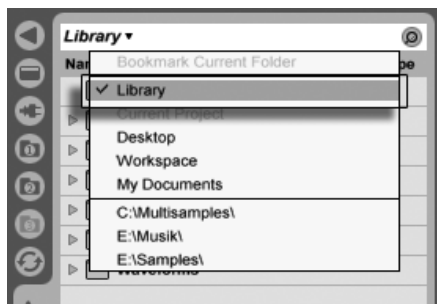

Choosing the Library Bookmark.

The first time you run Live, it will automatically install its Library to your standard user folder. You can, of course, **move it to a new location**. After installation the Library will already contain a few sound ideas, courtesy of Ableton. We encourage you to experiment with this material to get a sense of what the program can do, but we do not recommend removing or changing the contents of the factory Library.

Ableton provides additional Library content in the form of *Live Packs* which are available from installation CDs, DVDs or **the Ableton website**². Owners of a boxed version of Live can

²<http://www.ableton.com/downloads>

enjoy the [Essential Instrument Collection](#), a multi-gigabyte library of meticulously sampled and selected instruments.

Chapter 5

Managing Files and Sets



Various types of files are used in making music with Live, from those containing **MIDI** and **audio**, to more program-specific files such as **Live Clips** and **Live Sets**. This chapter will explain everything you need to know about working with each of these file types in Live. However, we should first take a look at Live's File Browsers, through which most files arrive in the program.

5.1 Working with the File Browsers

Live offers three File Browsers which can be accessed via their selector buttons.



The File Browser Selector Buttons.

Each Browser can point to a different disk location, which Live will remember across sessions. The Browser display is divided into columns corresponding to “Name”, “Date,” “Live Pack,” etc., which you can show and hide using the  (PC) /  (Mac) context menu options.

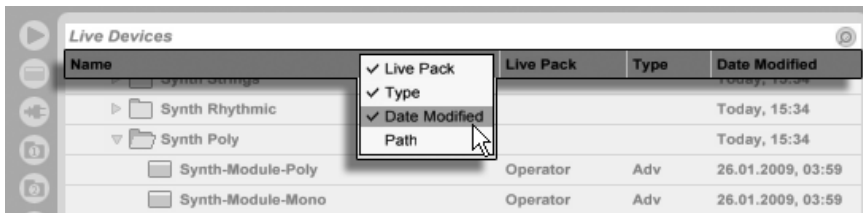

Showing/Hiding Browser Columns.

Columns can be reordered by drag and drop. To resize the columns, drag their divider lines horizontally.



Resizing Browser Columns.

5.1.1 Browsing the Folder Hierarchy

Each of the three File Browsers has its own *root* directory, shown at the top of the Browser, the contents of which are available for browsing below.

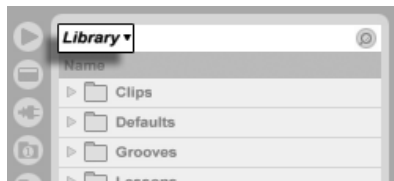

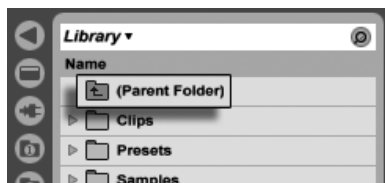

“Library” Is this Browser’s Root.

The Browser root can easily be changed: The topmost Browser item, called “Parent Folder,” will move the Browser root up one step up in the disk hierarchy when double-clicked.







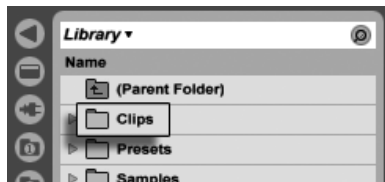



The File Browser’s “Parent Folder” Item.



You can also set the Browser root to any folder in the Browser via the  (PC) /  (Mac) context menu, by double-clicking the folder, or by selecting it and pressing .



A Folder in the Browser.

Moving through the files in Live’s Browser can be done with either the mouse or the computer keyboard:

- Scroll up and down in the Browser with  and , the mousewheel, or by clicking and dragging while holding the   (PC) /   (Mac) modifier.
- Close and open folders with  and .
- Jump to the parent folder of any closed folder using . (*Hint: If executed on a top-level folder, this is an alternative to selecting the “Parent Folder” item, and will move the Browser root up one level.*)

To clean up the Browser, use  (PC) /  (Mac) to access the context menu, and then select the Close All Folders option to show only top-level folders. Double-clicking a

File Browser's selector button will do the same.

5.1.2 Browser Bookmarks



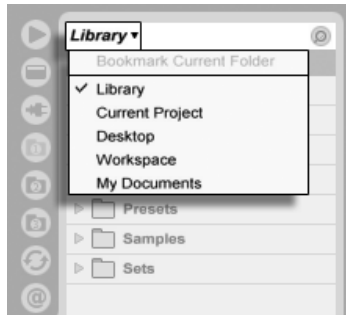



Using bookmarks, you can quickly save and recall frequently used folder locations in the Browser. Clicking in the Browser's title bar will open the Bookmark menu.



The Bookmark Menu.

The Bookmark menu lists a number of preset bookmarks such as *Desktop* and *Library*. Selecting the latter will bring you to the [Live Library](#). To bookmark the current Browser root, choose the Bookmark menu's topmost item, the Bookmark Current Folder command. Note that if the current Browser root is *already* bookmarked, the topmost option in the Bookmark menu will remove the bookmark. All File Browsers share the same set of bookmarks; a bookmark stored in one Browser can be accessed from another.

5.1.3 Searching for Files

Live's File Browsers are equipped with a search function for finding files. Clicking the Search button in the upper right corner of the Browser or using the    (PC) /    (Mac) shortcut will open the Browser's Search Mode.

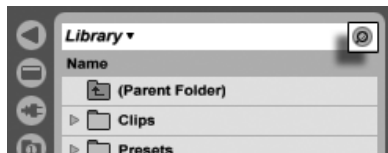

Activating Browser Search Mode.

After entering your search terms, begin the search by clicking the Go button or pressing **Return** on your computer keyboard.

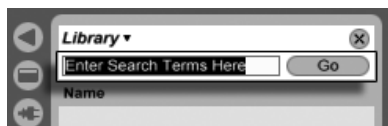

The Search Field and Go Button.

Live will search the entire Browser root for your search terms. The results will include files that match *all* search terms, as opposed to *any*. For example, if you search for "acoustic bass," the search will yield all acoustic bass sounds – not all acoustic sounds and all bass sounds.

The search function matches the entered criteria not only to any part of a file's name and suffix (e.g., ".wav") but also to any part of its file path. This means that a search for "bass," for example, will yield not only files with names containing the word "bass" but also those located in folders with names containing the word "bass." Compressed sample metadata tags are also included in the search, making it possible to search for songs from a specific album or artist, for example. The names of MIDI tracks within multitrack MIDI files are also included in searches.

Live maintains an index of the hard disk so that it can deliver search results instantly. The index is kept up to date as you create, install, delete, rename and move files within Live – it has no way of knowing, however, what you are doing outside of Live. If you have subsequently moved files using programs other than Live, the initial results of a search might be incomplete. The Go button's label will change to "Rescan." If you can't find a file in the search results, or need to be sure that the results are comprehensive, click the Rescan button (or **Return** once more), and Live will rebuild its index for the current Browser root.

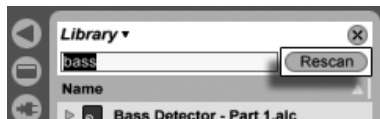

The Rescan Button.

Automatic rescanning for new searches can be activated and deactivated in the File/Folder Preferences.

While a search/rescan is going on, the adjacent search button is labeled “Stop.” Rescanning happens in the background, and you can keep making music while Live does its work, but you can also abort the search with this button if the disk traffic is bothering you.

You can go back to the Browser’s folder view at any time by closing the search field.



Closing the Search Field...

If you select a file from the search results and then close the search field, Live makes sure that file remains selected in the folder view, opening folders as required:

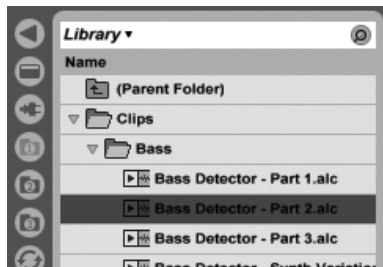

... Locates the File Last Selected Among the Search Results.

If a search is in progress, closing the field immediately stops the search, although navigating to other Browsers does not. In fact, while you’re waiting for a search to finish in one Browser, you can initiate separate searches in the others. A Browser that is in an active search will indicate this via a small rotating ring on the Browser button.



The Rotating Ring Means That a Search is in Progress.

For mouse-free searching, we suggest the following sequence of shortcuts:



- 1) **Ctrl** + **⌘** + **F** (PC) / **⌘** + **⌘** + **⌘** + **F** (Mac) to open the search field;
- 2) Type your search terms;
- 3) **Return** to "Go";
- 4) **↓** to jump to the search results;
- 5) **↑** and **↓** to scroll the search results;
- 6) **Ctrl** + **⌘** + **F** (PC) / **⌘** + **⌘** + **⌘** + **F** (Mac) to close the search field and go back to the folder view.

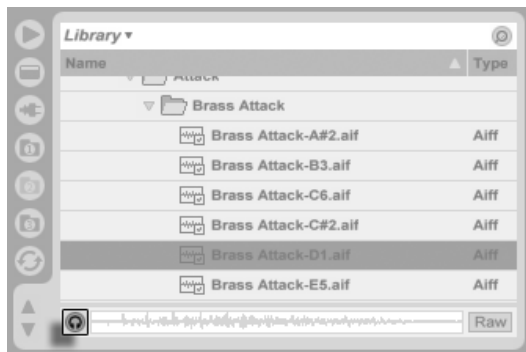

5.1.4 Previewing Files

Live allows you to preview samples and clips in the File Browser before they are imported into the program. To enable previewing, activate the Preview switch next to the Preview Tab at the bottom of the Browser.



The Preview Switch.

Hint: You can preview files even when the Preview switch is not activated by pressing  Return or .

Click on a sample file (or use  and ) to select it. Click in the Tab's scrub area to make playback jump to that point. (Note that it is not possible to scrub clips that have been saved with Warp turned off.)

You can also select **Live Clips** in the Browser to load them into the Preview Tab, but they will not play automatically. You can click on the tab or press  to preview them.

With the Raw button enabled, files will preview at their original tempo and will not loop. With Raw disabled, Live will try to preview files in sync with the current Set, so that you can better judge which samples will work for you. Please note that scrubbing is not possible when Raw is enabled.

The previewing volume can be adjusted using the mixer's Preview Volume knob.

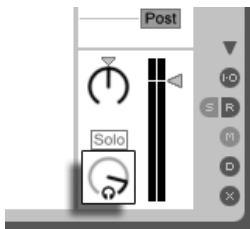

The Preview Volume Knob.

If your audio hardware offers multiple audio outs, you can privately audition, or *cue*, files via headphones connected to a separate pair of outs – while the music continues to play.

To learn how to set up Live for cueing, please refer to the [relevant section](#) of the Mixing chapter.

5.1.5 Adding Clips from the Browser

There are several ways to add clips to a Live Set:

- Files can be dragged and dropped from the File Browsers into tracks in the Session or Arrangement View. Dragging and dropping material from the Browser into the space to the right of Session View tracks or below Arrangement View tracks will create a new track and place the new clip(s) there.

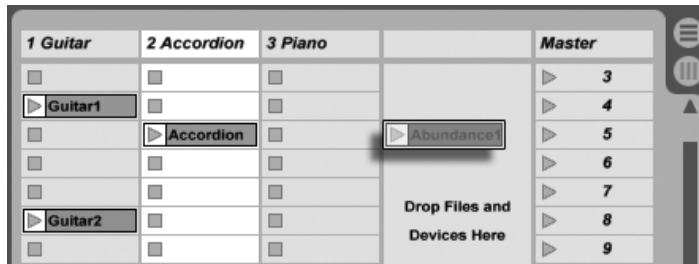

Dropping a Clip to Create a New Track.

- In the Session View, double-clicking or pressing `Return` on a file in the Browser will automatically create a new track to the right of the other tracks and load it with the clip.
- Files can be dropped directly into Live from the Explorer (Windows)/Finder (Mac).

5.1.6 File Maintenance in the Browser

You can use Live's File Browsers for all of the file maintenance activities that you are familiar with on your operating system.

- **Move files and folders** by dragging and dropping, or by copying/cutting and pasting. Copying, cutting and pasting can be done with either Edit menu commands or [keyboard shortcuts](#). A file can be moved from one File Browser to another by dragging it over the target Browser's  button.

- **Rename files and folders** using the Edit menu's Rename command or the **Ctrl** **R** (PC) / **⌘** **R** (Mac) shortcut. Cancel renaming with the **Esc** key.
- **Create folders** by opening the context menu with **⌘** (PC) / **Ctrl** **⌘** (Mac), and then selecting the Create Folder command.
- **Delete files and folders** using the Edit menu's Delete command or your computer's **←** or **Delete** key. Deleting items within Live moves them to the system trash; if necessary, you can recover items from the system trash via your computer's operating system.

5.1.7 Hot-Swap Mode

In addition to the drag-and-drop method of loading files from the Browser, Live offers a *Hot-Swap Mode* to save you mouse travel. Hot-Swap Mode establishes a temporary link between the Browser and, for example, a virtual instrument. While in Hot-Swap Mode, you can step through samples or presets to audition them “in place,” that is, within the instrument. Hot-swapping for presets is covered in the [Live Device Presets section](#). Let's go through an example of hot-swapping samples:

Live's built-in [Impulse](#) instrument features eight sample-player slots that can be filled by dropping samples into them. Alternatively, we can click the Hot-Swap button that appears as we move the mouse over a slot.



The Hot-Swap Button in an Impulse Slot.

Clicking the Hot-Swap button engages Hot-Swap Mode: Live's *Hot-Swap Browser* opens, and the Hot-Swap icon appears next to one of the files shown.



The Hot-Swap Browser.

While in Hot-Swap Mode, pressing the **Return** key loads that file into the Impulse slot (presumably while Impulse is playing incoming MIDI notes); pressing **↓**, then **Return** loads the next sample, and so on. Instead of using the keys, we can also click on the file's Hot-Swap icon to load it. The link between the Browser and the instrument will be broken if a different view is selected, or if the Hot-Swap button is pressed again. Hot-swapping can also be cancelled with a press of the **Esc** key or by pressing the close button in the Hot-Swap bar at the top of the Browser.

When Hot-Swap Mode is re-entered, the Hot-Swap Browser will try to reconstruct what you saw when you loaded the current file into the Impulse slot. If, for instance, the current file was found by searching for "gretsch kick," the Hot-Swap Browser will come up with that search string in the search field. In our example, we were hot-swapping for an empty Impulse slot, so Live came up with something appropriate: a search for "Drum Kick" in Library/Samples/Waveforms.

5.2 Sample Files

A *sample* is a file that contains audio data. Live can play both uncompressed file formats (WAV, AIF, REX and Sound Designer II for Mac) and compressed file formats (MP3, AAC, Ogg Vorbis, Ogg FLAC and FLAC).

A note on using Variable Bit Rate (VBR) files: Please install QuickTime for decoding purposes if you do not already have it on your system. It can be downloaded from the [Apple website](http://www.apple.com/quicktime/download)¹.

As Live plays the samples directly from disk, you can work with a large number of (large) samples without running into RAM memory limitations. Please note, however, that you may run into disk throughput problems if your disk is nearly full, and/or (on Windows systems) highly fragmented. Hard drive rotation speed can also affect disk performance. Refer to the section on [managing the disk load](#) for more information.

Live can combine uncompressed mono or stereo samples of any length, sample rate or bit depth without prior conversion. To play a compressed sample, Live [decodes](#) the sample and writes the result to a temporary, uncompressed sample file. This usually happens quickly enough that you will be able to play the sample right away, without waiting for the decoding process to finish.

Note: When adding a long sample to a project, Live might tell you that it cannot play the sample before it has been analyzed. Please see the section on [analysis](#) for an explanation.

5.2.1 The Decoding and Web Cache

To save computational resources, Live keeps [downloaded Sets](#) and the decoded sample files of compressed samples in the *cache*. Maintenance of the cache is normally not required, as Live automatically deletes older files to make room for those that are new. You can, however, impose limits on the cache size using the File/Folder Preferences' Decoding & Web Cache section. The cache will not grow larger than the Maximum Cache Size setting, and it will always leave the Minimum Free Space on the hard disk. Pressing the nearby Cleanup button will delete all files not being used by the current Live Set.

¹<http://www.apple.com/quicktime/download>

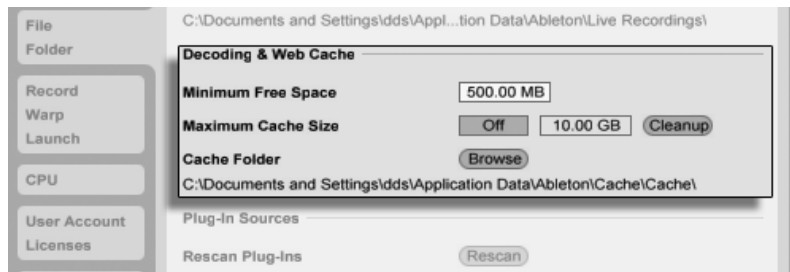

Preferences for the Decoding and Web Cache.

5.2.2 Analysis Files (.asd)

An *analysis file* is a little file that Live creates when a sample file is brought into the program for the first time. The analysis file contains data gathered by Live to help optimize the stretching quality, speed up the waveform display and **automatically detect the tempo of long samples**.

When adding a long sample to a project, Live might tell you that it cannot play the sample before it has been analyzed. This will *not* happen if the sample has already been analyzed (i.e., Live finds an analysis file for this sample), or if the Record/Warp/Launch Preferences' **Auto-Warp Long Samples preference** has been deactivated. To prevent waiting for analysis of longer samples, you can **pre-analyze them** via the Browser, as we will see in a moment.

An analysis file can also store *default clip settings* for the sample:

Clicking the Clip View's **Save button** will store the current clip's settings with the sample's analysis file. The next time the sample is dragged into Live, it will appear with all its clip settings intact. This is particularly useful for retaining **Warp Marker settings** with the sample. Storing default clip settings with the analysis file is different from **saving the clip as a Live Clip**.

While analysis files are a handy way to store default information about a particular sample's settings, keep in mind that you can use different settings for each clip within a Live Set – even if those clips refer to the same sample on disk. But if you drag a *new version* of the sample into a Live Set, Live will use the settings stored in the analysis file for the newly created clip.

The analysis file's name is the same as that of the associated sample, with an added ".asd" extension. Live puts this analysis file in the same folder as the sample.



Samples that have an .asd file are displayed like this in the Browser.





Samples without an .asd file look like this.

The analysis files themselves do not appear in Live's Browsers.

Note that you can suppress the creation of .asd files by turning off the Create Analysis Files option in the File/Folder Preferences. All data (except for the default clip settings) can be recreated by Live if the .asd file is missing, however this will take some time for longer samples.

5.2.3 File Pre-Analysis

To avoid waiting for longer samples to be analyzed the first time they are imported into Live, you may want to pre-analyze them.

To pre-analyze all the files contained in any folder in the Browser, use the  (PC) /   (Mac) context menu's Analyze Audio command. This process can also be cancelled via the context menu.

5.2.4 Exporting Audio and Video

The File menu's *Export Audio/Video* command allows you to export Live's audio output as new samples. The resulting files can be used to burn an audio CD for listening purposes or a data CD, which could serve as a backup of your work or be used with other digital audio applications. If your set includes video, you can also use the Export Audio/Video command to export this to a new video file, which will be created in the same directory as the rendered audio files.

Which Signal Will Be Rendered?

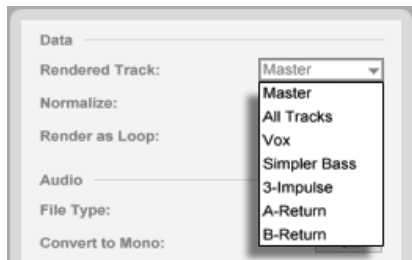

The Rendered Track Chooser.

The Export dialog's Rendered Track chooser offers several options for which audio signal to render:

- *Master* – the post-fader signal at Live's Master output. If you are monitoring the Master output, you can be sure that the rendered file will contain exactly what you hear.
- *All tracks* – the post-fader signal at the output of each individual track, including return tracks and MIDI tracks with instruments. Live will create a separate sample for each track. All samples will have the same length, making it easy to align them in other multitrack programs.
- *Individual tracks* – the post-fader signal at the output of the selected track.

When Export Audio/Video is invoked while the Arrangement View is up, Live will render the selected time range.

If you would like to render the current Arrangement loop, choose the Select Loop command from the Edit menu prior to choosing Export Audio/Video. If you choose Export Audio/Video while the Session View is up, Live will ask you to specify the length of the sample to be rendered. The Export Audio/Video dialog will come up with a bars-beats-sixteenths field where you can type in the desired length. Live will capture audio starting at the current play start position for whichever duration you have specified.

Remember – a rendered audio file contains only what you heard prior to rendering. So, for example, if you're playing back some combination of Session View clips and Arrangement material, then that is what will be captured in your rendered file – regardless of which view is active when you render.

Audio Rendering Options

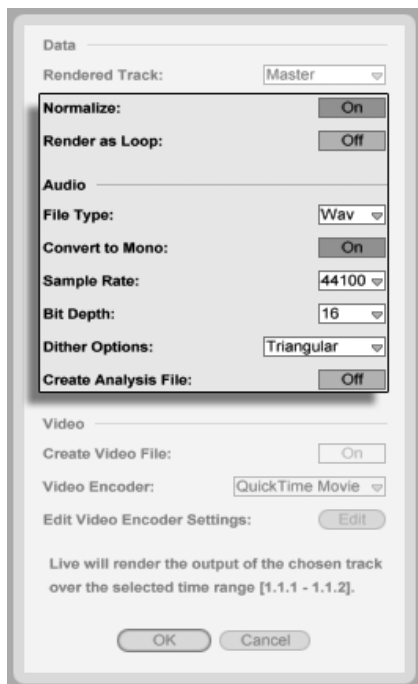

Audio Rendering Options.

The Export dialog offers several audio rendering options:

- *Normalize* – If this is activated, the sample resulting from the render process will be normalized (i.e., the file will be amplified so that the highest peak attains the maximum available headroom).
- *Render as Loop* – If this is activated, Live will create a sample that can be used as a loop. For example, suppose your Live Set uses a delay effect. If Render as Loop is on, Live will go through the rendering process twice: The first pass will not actually write samples to disk, but add the specified delay effect. As the second pass starts writing audio to disk, it will include the delay “tail” resulting from the first pass.
- *File Type, Bit Depth, Sample Rate* – These options specify the type of sample to be

created.

- *Convert to Mono* – If this is activated, Live will create a mono file instead of a stereo file.
- *Dither Options* – If you are rendering at a bit depth lower than 32-bit, choose one of the dither modes. Dithering adds a small amount of noise to rendered audio, but minimizes artifacts when reducing the bit depth. By default, Triangular is selected, which is the “safest” mode to use if there is any possibility of doing additional processing on your file. Rectangular mode introduces an even smaller amount of dither noise, but at the expense of additional quantization error. The three Pow-r modes offer successively higher amounts of dithering, but with the noise pushed above the audible range. Note that dithering is a procedure that should only be applied *once* to any given audio file. If you plan to do further processing on your rendered file, it’s best to render to 32-bit to avoid the need for dithering at this stage. In particular, the Pow-r modes should *never* be used for any material that will be sent on to a further mastering stage – these are for final output only.
- *Create Analysis File* – If this is activated, Live will create an .asd file that contains analysis information about the rendered sample. If you intend to use the new sample in Live, check this option.

Real-Time Rendering

Normally, rendering happens as an offline process. But if your set contains an [External Audio Effect](#) or [External Instrument](#) that routes to a hardware effects device or synthesizer, the rendering process is a bit different. In this case, rendering the master output happens in real time. If you render individual tracks, all tracks that don’t route to an external device anywhere in their signal paths will be rendered offline. Then, any tracks that do access these devices will be rendered in real time. Live will automatically trace each track’s signal flow and detect if real-time rendering is necessary. You’ll then be presented with several options when you start to render:

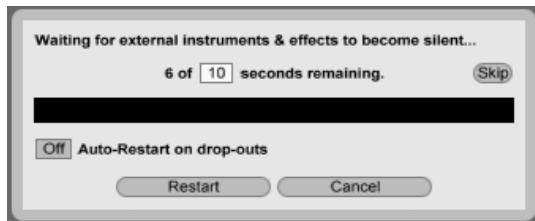

Waiting for External Devices to Become Silent.

- *Skip* – By default, Live will wait for ten seconds before starting a real-time render. This should allow any sound from external devices to fade out, but if you need more time (for example, if you're waiting for a long reverb tail), you can increase the wait time by typing a new number in the number box. On the other hand, if you're sure that your external devices aren't making any sound, you can speed the process along by pressing "Skip," which will start the render immediately.

After the render has begun, the dialog changes to show a recording progress bar:

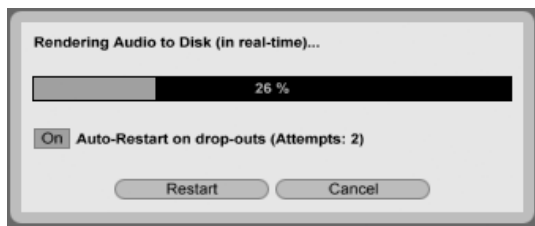

Real-Time Rendering in Progress.

- *Auto-Restart on drop-outs* – Rendering in real-time requires somewhat more CPU power than non-real-time rendering, and in some cases drop-outs (small gaps or glitches in the audio) can occur. Live detects when drop-outs happen, and rendering will start again from the beginning if the Auto-Restart option is enabled.
- *Restart* – manually restarts the rendering process.
- *Cancel* – stops the rendering process and deletes the partially rendered file.

The number of rendering attempts (if there has been more than one) will also be listed in the dialog box. If you find that dropouts and restarts keep happening, you should close other running applications to allow more processing power for rendering. Please see the chapter on [computer audio resources](#) for more tips on improving performance.

Rendering Video



Video Rendering Options.

In addition to settings for audio rendering, the Export dialog provides additional options for rendering video:

- *Create Video File* – If this is activated, a video file will be created in the same directory as your rendered audio. Note that this option is only enabled if you have video clips in the Arrangement View. Also, it is not possible to only render a video file – enabling video rendering will always produce a video in addition to rendered audio.
- *Video Encoder* – This chooser allows you to select the encoder to use for the video rendering. The choices you have here depend on the encoders you have installed.
- *Edit Video Encoder Settings* – This button opens the settings window for the selected encoder. Note that the settings options will vary depending on the encoder you have chosen. Certain encoders have no user-configurable options. In this case, the Edit button will be disabled.

Once you've made your selections and clicked OK to begin the rendering process, audio rendering will begin. After the audio rendering is complete, the video will be rendered. Note that, depending on the encoder used, video rendering may occur in more than one pass. Live will display a progress bar that will indicate the status of the process.

Unless you've specified a special window size or aspect ratio in the encoder settings, the rendered video file will play back exactly as it appeared during real time playback in Live. The video file will also contain the rendered audio.

For more information about working with video in Live, see the [chapter on video](#).

5.3 MIDI Files

A MIDI file contains commands that prompt MIDI compatible synthesizers or instruments, such as Live's [Simpler](#), to create specific musical output. MIDI files are exported by hardware and software MIDI sequencers. Importing MIDI files into Live works differently than with samples: MIDI file data is incorporated into the Live Set, and the resulting MIDI clips lose all reference to the original file. MIDI files appear as folders in the File Browser; opening the folders gives you access to the file's individual tracks (also called "voices" or "instruments").



A MIDI File and its Tracks in the Browser.

Note that while you can rename or delete entire MIDI files via the Browser, this is not possible with the individual MIDI tracks contained within them. This is also the case with the individual components of [Live Sets](#).

5.3.1 Exporting MIDI Files

Live MIDI clips can be exported as Standard MIDI files. To export a MIDI clip, use the File menu's Export Selected MIDI Clip command. This command will open a file-save dialog, allowing you to choose the location for your new MIDI file.

Exporting a MIDI file is different from [saving the clip as a Live Clip](#).

5.4 Live Clips

Individual clips can be exported to disk in the Live Clip format for easy retrieval and reuse in any project. Because they only contain references to samples on disk (rather than the audio data itself), Live Clips are very small, which makes it easy to develop and maintain your own collection.

To save a clip from the open Live Set to disk, simply drag it to the File Browser and drop it into any folder. Live will manage the copying of the clip's sample into this new location based on the selection in the [Collect Samples on Export](#) chooser. You can then type in a new name for the clip or confirm the one suggested by Live with `Return`.

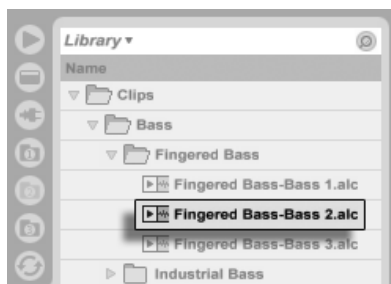

A Live Clip in the Browser.

Live Clips are a great way of storing your ideas for later use or development, as they save not only the original clip, including all its clip and envelope settings, but also the original track's devices. In order to recreate a Live Clip's device chain, either [import it](#) into a track containing no clips or devices, or drag it into the space in the Session or Arrangement View containing no tracks. Note that Live Clips that are imported into tracks already containing devices or clips will appear with their clip settings but not their devices. You could, for instance, drop a bassline Live Clip on an existing track that drives a bass instrument, rather than creating a new track.

Clips belonging to any Live Sets already on disk are also Live Clips. Please see the section on [merging Sets](#) for more on this topic.

Note that [storing default clip settings with a sample's analysis file](#) is different from saving a Live Clip. The default clip in the .asd file annotates the sample with sensible default values (warp, gain and pitch settings) so that it will play in a defined way when it is added to a Set. Live Clips, on the other hand, are stored on disk as separate musical ideas. For example, you

could create a number of variations from the same audio clip by using different warp, pitch, envelope and effect settings, and store them all as separate Live Clips. In the Browser, you could then independently sort and preview these clips, even though they are all referring to the same source sample.

5.5 Live Sets

The type of document that you create and work on in Live is called a *Live Set*. Think of this as a single “song.” Sets must be saved inside projects, so that Live can keep track of and manage all of the various components of the Live Set: Live Clips, device presets, any samples used, etc.

5.5.1 Creating, Opening and Saving Sets

Use the File menu’s New Live Set command to create new Live Sets, and the Open or Open Recent command to open existing ones. In the File Browser, you can double-click or press **Return** on a Live Set to open it.

The File menu’s Save command saves the current Live Set exactly as it is, including all clips and settings.

You can use the Save As command to save the current Live Set under a different name and/or in a different directory location, or the Save a Copy command to create a copy of the current Live Set with a new name and/or new directory location. Live Sets can also be saved to the Ableton server via the Share Live Set command. Uploaded Sets can then be [shared with other Live users](#).

5.5.2 Merging Sets

Live makes it easy to merge Sets, which can come in handy when combining work from different versions or pieces. To add all tracks (except the return tracks) from one Live Set into another, drag the Set from the File Browser into the current Set, and drop it onto any track title bar or into the drop area next to or below the tracks. The tracks from the dropped

Set will be completely reconstructed, including their clips in the Session and Arrangement View, their devices, and their automation.

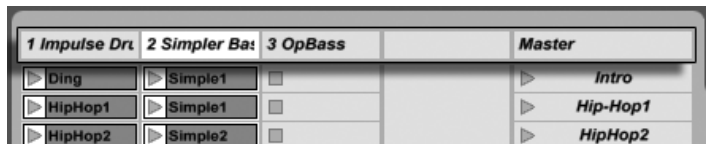

Session View Drop Area for Importing Live Sets.

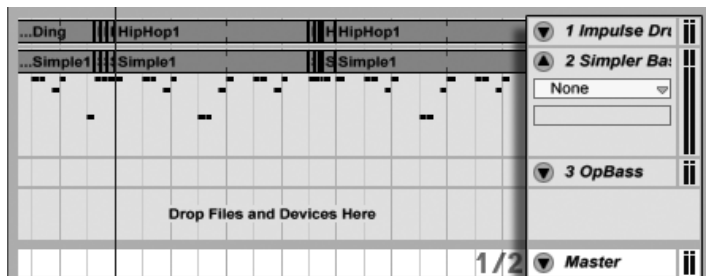

Arrangement View Drop Area for Importing Live Sets.

If you prefer to import individual tracks from a Set, you can unfold the Live Set in the File Browser just as if it were a folder.

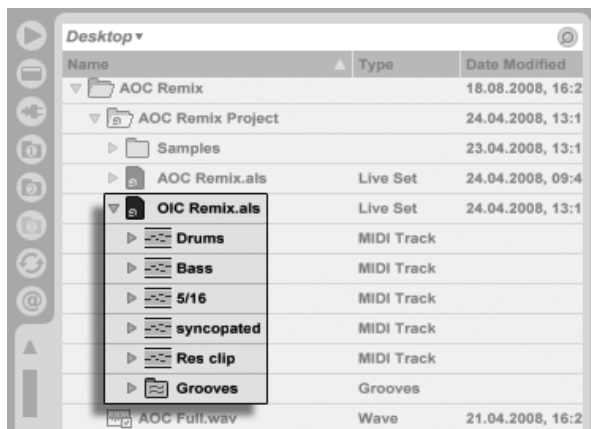

Unfolding a Set to Reveal its Contents.

You can now drag the individual tracks and drop them as described at the beginning of this section. Any **grooves** that were saved with your Set are also available as a folder within the

unfolded Set.

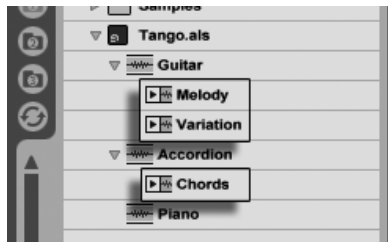

Of the three tracks contained in the Set shown in the following figure, two contain Session View clips. These can be accessed by unfolding the tracks:



Revealing the Session View Clips Contained in a Set.

You can browse, preview and import Session View clips from the Set as if they had been stored as individual **Live Clips**. This, basically, means that any Live Set can serve as a pool of sounds for any other, suggesting creative reuse and crossover.

5.5.3 Exporting Session Clips as New Sets

You can export a selection of Session View clips as a new Live Set by dragging them to the File Browser. To export a Set, first click and drag, or use the  or  (PC) /  (Mac) modifiers, to select more than one Session View clip. Then, simply drag the clips to a folder in the File Browser, where you can either confirm Live's suggested name or type in one of your own.

5.5.4 Template Sets

Use the File/Folder Preferences' Save Current Set as Default button to save the current Live Set as the default template. Live will use these settings as the initialized, default state for new Live Sets. You can use this to pre-configure:

- Your multichannel input/output setup.
- Preset devices, like EQs and Compressors, in every track.
- **Computer key mappings.**

- MIDI mappings.

The template Live Set, “Template.als,” is located in Live’s Preferences folder and can be copied or deleted from there. The easiest way to locate this folder is to search your disk for “Template.als.”

In addition to the template Set that loads by default, the Live Library contains a folder called “Templates.” This is a collection of Sets with pre-configured tracks and **routing configurations** for a variety of common recording scenarios.

5.5.5 Viewing and Changing a Live Set’s Sample References

To view a list of the samples referenced by the current Live Set, choose the Manage Files command from the File menu, click the Manage Set button, and then click the View Samples button. Live will display one line for each sample used by the Live Set. To list all clips or instruments in the Live Set where the sample is actually used, click the triangle to expand the line. Here is what you can do:

- **Replace a sample** – Dragging a sample from the File Browser and dropping it on an entry in the list makes the Live Set reference the new sample instead of the old one. For samples used in audio clips, Live retains the clip properties; the **Warp Markers** are kept if the new sample has the same or a greater length as the old sample and discarded otherwise. Please note that replacing a sample will change *all* clips in your set that reference this sample.

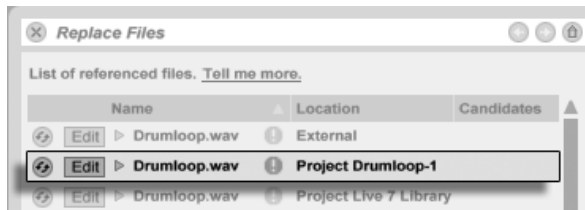

Every Entry in the Sample Reference List is a Drop Target for Samples.

- **Hot-swap samples** – Using the Hot-Swap button at the left-hand side of each entry, you can quickly browse through alternatives for the sample that is currently being referenced. This is like dragging samples here, only quicker.

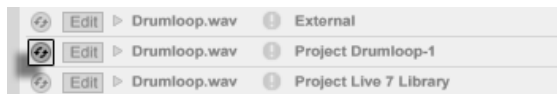

The Sample Reference List's Hot-Swap Button.

- **Edit a referenced sample** – using an external application (which can be chosen in the Preferences' File/Folder tab). Clicking the Edit button will open the referenced sample in the external application. The sample will remain offline as long as the Edit switch is engaged. For samples used in audio clips, the current set of Warp Markers is retained only if the sample length remains the same as before.

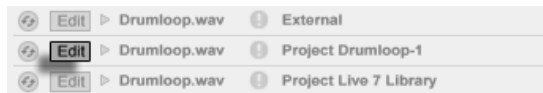

The Sample Reference List's Edit Switch.

- **View a sample's location** – The Location column states if a sample is **missing**, or if it resides in the **Live Library**, a **Project** or somewhere else ("external"). When unfolded, the entry shows the specific places in the Set where the sample is used.

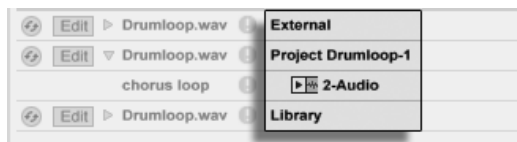



The Sample Reference List's Location Column.

5.6 Live Projects

A *Live Project* is a folder containing Live-related files that belong together. Consider, for example, work on a piece of music: You start out with an empty Live Set; you record audio and thereby create new sample files; you drag in samples from collections; you save different versions of the Live Set along the way so that you can go back and compare. Perhaps you also save Live Clips or device presets that “belong” to this particular musical piece. The project folder for this Live Project will maintain all the files related to this piece of music – and Live's *File Manager* will provide the tools you need to **manage them**.

5.6.1 Projects and Live Sets

You can manually create a Project by clicking  (PC) /   (Mac) in the Browser and selecting Create Project from the context menu. Usually, Live takes care of this automatically. When you save a Live Set under a new name or in a new folder location, Live will create a new project folder and store the Live Set there – unless you are saving the Live Set into an existing Live Project. Let's look at an example to illustrate this process:

We have recorded some audio into a new Live Set. We now save the Live Set under the name “Tango” on the Desktop. Here is the result as displayed by the Live Browser:



A Live Set and its Recordings in a Live Project Folder.

The project folder (“Tango Project”) contains the Live Set (“Tango.als”) and a Samples folder, which in turn contains a Recorded folder with two samples in it. Note that the current Project is also indicated in the title bar of Live’s application window.

Next, we record another track into our Project. We save the modified version of the Live Set under a new name so that we do not lose the previous version. Accepting the Save As command’s default suggestion, we store the new version of the song in the Tango Project folder.



A Second Version of the Live Set Has Been Added to the Project.

The Tango Project now contains two Live Sets, and its Samples/Recorded folder contains the samples used by both of them.

And now for something completely different: We choose the File menu's New command and record a samba tune. As this has nothing to do with our tango dabbings, we decide to save it outside the Tango Project folder, say on the Desktop. Live creates a new project folder named Samba Project next to Tango Project.



A New Project Was Added Next to Tango Project.

So far we have seen how to create Live Projects and save versions of Live Sets into them. How do we open a Project? Simply by opening any of its contained Live Sets. Double-clicking "Tango with Piano.als" opens that Set and the associated Project – as displayed in Live's title bar.

Let's suppose that, in the course of our work on "Tango with Piano.als," we get sidetracked:

The piece evolves towards something entirely different, and we feel that it should live in a Project of its own. So, we “Save As...” under a new name and in some location outside the current Project, say the Desktop:



A New Project Was Added by Saving a Live Set Outside its Original Project.

Note that the new project folder has no Samples folder (yet). “Electro with Piano.als” is still referencing the piano sample from the original Tango Project. There is nothing wrong with this except for when the Tango Project is moved away or deleted; then “Tango with Piano.als” will be missing samples. You can prevent this by [collecting samples](#). Even after the fact, Live’s [tools for searching missing samples](#) can help solve this problem.

There is actually no need to keep a Project’s Live Set exactly one level below the Project itself. Within a project folder, you can create any number of sub-folders and move files around to organize them as desired, although you may need to use the [File Manager](#) to “teach” the Project about the changes you’ve made.

In general, Live will do what it can to prevent situations such as orphaned (Project-less) Live Sets (and Live Clips and presets), which have the potential of confusing both the user and Live’s file management tools. It cannot, however, control situations in which Sets or files are moved out of order and become disorganized via the Explorer (Windows)/Finder (Mac).

A note for users of older Live versions: Live 8 does not allow overwriting Live Sets that were created by older versions to prevent compatibility problems. Instead, you will be requested to “Save As...”. Doing this will insure that the newly saved Live Sets reside in project folders.

5.6.2 Projects and Presets

By default, new instrument and effect presets are stored in the **Live Library**, making them available to any project. At times however, it may make more sense to save a preset with the current Project. You might, for example, want to keep a number of alternative master EQ settings for a given piece. These EQ presets are specific to the piece and of little use to other Projects. For this reason, every device in the Device Browser has a Current Project sub-folder. You can drag a preset to this folder after **saving** it, or simply drag the title bar of the device and drop it there directly.



When saving presets that contain samples to a new location, Live may copy the samples depending on the settings in the **Collect Samples on Export** chooser in the File/Folder Preferences. You can then type in a new name for the device or confirm the one suggested by Live with **Return**.

Project-Specific Presets Appear Under “Current Project” in the Device Browser.

5.6.3 Managing Files in a Project

Live’s File Manager offers several convenient tools for managing Projects. Once you’ve opened a Live Set that is part of the Project you wish to manage, choose the Manage Files

command from the File menu, and then click the Manage Project button. The File Manager will present you with an overview of the Project's contents and tools for:

- locating samples that the Project is missing;
- collecting external samples into the Project;
- listing unused samples in the Project;
- packing a Project in Live Pack format;
- exporting the Project's contents to the Library.

5.7 The Live Library

The Live Library acts as a repository of commonly used files, such as samples, clips and **Live Device Presets**, that are available to all Live Projects. In Live's File Browsers, the Library is accessible through a bookmark:

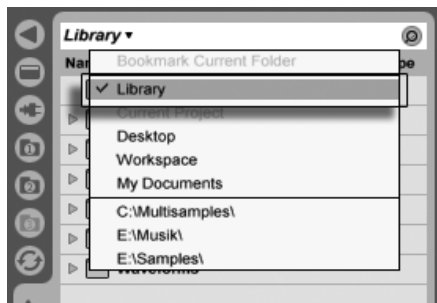

Choosing the Library Bookmark.

Clips can be conveniently saved in **Live Clip format** for later reuse by dragging them from the open Live Set into the desired folder in the Library. Device presets are saved in the Library by default (but you can also **save them with a Project**).

Ableton delivers Library content that can serve as a starting point for creative exploration. Content is shipped in the form of **Factory Live Packs**. Factory Live Packs are available from installation CDs, DVDs or **the Ableton website**². To install a Factory Live Pack in the Library,

²<http://www.ableton.com/downloads>

double-click the Live Pack file (.alp), drag it into the Live main window, or locate it via the File menu's Install Live Pack command.

A list of the currently installed Factory Live Packs is available from the Preferences' Library tab. Here you can select Live Packs from the list and click the Uninstall button to remove them. Multiple Live Packs can be selected and uninstalled at once.

By default, the Live 8 Library contains the following sub-folders:

- *Ableton Project Info* – contains files that Live uses to identify the Library and keep track of what Live Packs have been installed. You should *not* use or modify this folder or its contents.
- *Clips* – contains Live Clips, example Sets, construction kits (Session View-based song ideas), loops and other related items. The actual contents of this folder will vary, depending on what products and Live Packs you have installed. You can use this material in your own musical productions, or to get hints about ways to use Live. The construction kits, in particular, can be used in a variety of ways. Loading an entire construction kit loads a new Live Set. You can also [unfold the Set in the Browser](#) and import individual tracks or clips into a Set that's already in progress.
- *Defaults* – presets placed into the default device folders will load in place of Live's generic device settings. Additionally, the Defaults folder contains several special folders corresponding to user actions such as slicing and sample dropping. Presets placed in these folders define what Live will do when you perform the action.
- *Grooves* – all of Live's factory [groove files](#).
- *Lessons* – all of Live's built-in lessons, as well as any additional images and Live Sets that the lessons refer to. You should not change anything in this sub-folder.
- *Presets* – contains all of the factory presets for Live's devices.
- *Samples* – contains all of the samples that are used by Live's presets.
- *Templates* – contains a collection of template Sets with pre-configured tracks and [routing configurations](#) for a variety of common recording scenarios.

After you've been using Live for a while, you'll probably find that there are additional folders in your Library. This is normal. Installing Live Packs, recording your own samples, or performing other common procedures will change the folder structure over time.

5.7.1 Changing the Library Location, Upgrading an Old Library

The Library can reside in the hard drive location of your choice. In the Preferences' Library tab, you will find the Library Location chooser, which contains a list of Library locations that you've used in the past:

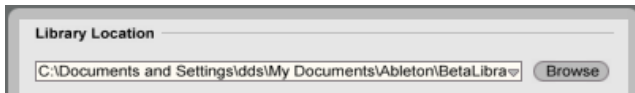

The Library Location Chooser.

If any of these previous Library locations are now unavailable (perhaps because of an unattached external drive, a moved or renamed folder, or an angry roommate) these will appear greyed-out in the list. If you know that these unavailable locations are gone for good, you can remove them by using the Clear Unavailable Locations option at the bottom of the chooser:



Unavailable Library Locations can be Cleared from the List.

You can also use the Browse button next to this chooser to create a new Library by pointing to an empty folder or creating a new one. Once you've selected a Library path, one of several possibilities will occur, depending on the new location:

- If the target location is an empty folder on a *different* hard drive, you will be given the option to *copy* your current Library to this new location. Live will then offer to open a Explorer (Windows)/Finder (Mac) window so that you can delete the Library from the old location.
- If the target location is an empty folder on the *same* hard drive, you will be given the option to *move* your current Library to this new location.
- If the target location is not empty but does not contain a Library, Live will create a subfolder called "Library" at this location, and then offer to copy/move the old Library contents.



In all three of these cases, you may also choose to create a new Library, without copying

or moving any content from the previous location. Live will then offer to install any default packages to the new location.

- If the target location is a Library that was made with an older version of Live, you will be warned about possible compatibility issues. It is generally not a good idea to try to share a single Library between two different versions of Live.

Note: Live will not allow you to create a Library inside an existing Project.

5.7.2 Importing Projects into the Library

You can merge the contents of a Live Project into the Library to make them available to any Project. To do this,  (PC) /   (Mac) on a Project folder in the File Browser and select the Manage Project command.

5.8 Locating Missing Samples

If you load a Live Set, Live Clip or preset that references samples which are missing from their referenced locations, Live's Status Bar (located at the bottom of the main screen) will display a warning message. Clips and instrument sample slots that reference missing samples will appear marked "Offline," and Live will play silence instead of the missing samples.

Live's File Manager offers tools for repairing these missing links. Click on the Status Bar message to access these. (This is actually a shortcut for choosing the Manage Files command from the File menu, clicking the Manage Set button, and then clicking the Locate button found in the Missing Files section.) The File Manager will present you with a list of the missing files and associated controls.

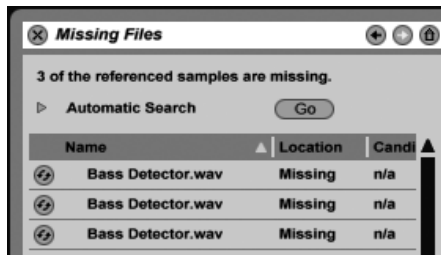

The File Manager's List of Missing Samples.

5.8.1 Manual Repair

To manually fix a broken sample reference, locate the missing sample in the File Browser, drag it over to the File Manager and drop it on the respective line in the list of missing files. Note that Live will not care if the sample you offer is really the sample that was missing.

5.8.2 Automatic Repair

Live offers a convenient automatic search function for repairing sample references. To send Live on a search, click the Automatic Search section's Go button. To reveal detailed options for guiding the automatic search function, click the neighboring triangular-shaped button.

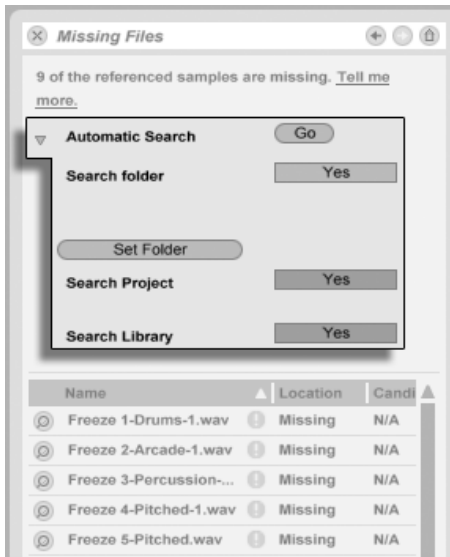

Automatic Repair
Options in the File
Manager.

- *Search Folder* – includes a user-defined folder, as well as any sub-folders, in the search. To select the folder, click the associated Set Folder button.
- *Search Project* – includes this Set's **project folder** in the search.
- *Search Library* – includes the **Live Library** in the search.

For each missing sample, the automatic search function may find any number of *candidates*. Let's consider the following cases:

- *No candidate found* – you can choose another folder and try again, or locate the sample manually.
- *One candidate found* – Live accepts the candidate and considers the problem solved.
- *Several candidates found* – Live requires your assistance: Click the Hot-Swap button (i.e., the leftmost item in every line of the list of missing samples) to have the File Browser present the candidates in **Hot-Swap Mode**. You can now double-click the candidates in the File Browser to load them, as the music plays if you like.

5.9 Collecting External Samples

To prevent a Live Set from containing **broken sample references**, Live provides the option of **collecting** (i.e., copying) them into the Set's **project folder**. This is accomplished via the File Manager:

- Choose the Manage Files command from the File menu
- Click the Manage Set button
- Unfold the triangular-shaped fold button in the External Samples section.

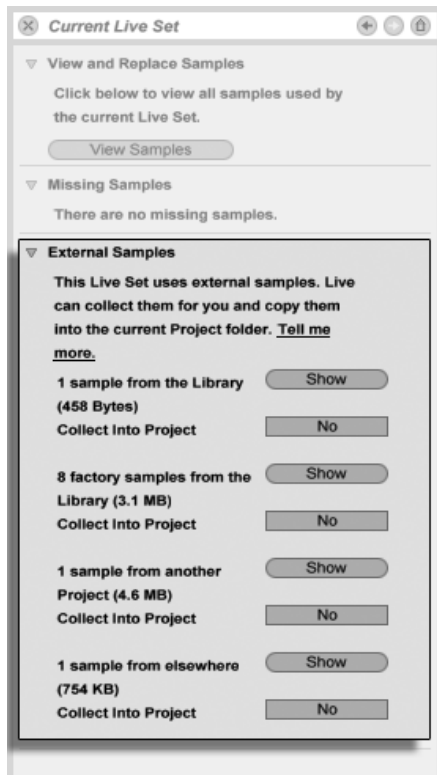

Options for Collecting External Samples.

Separated by location (the Library, installed by factory Live Packs, other Projects and elsewhere – sample collections from external drives, for example), the File Manager provides:

- A sample count and the associated disk space used;
- A Show button that will list the samples in the File Browser;
- A Yes/No toggle for engaging or disengaging collection.

Note: Make sure to confirm your choices by clicking the File Manager's Collect and Save button!



*The File Manager's
Collect and Save Button.*

The File menu's Collect All and Save command is a shortcut that collects and saves all external samples referenced by the current Set, including those from the Library. Note that this can cause a lot of copying, especially if your Live Set uses large multisample collections!

5.9.1 Collect Samples on Export







When you save Live Clips, device presets or tracks by dragging them into the Browser, Live manages the copying of associated samples based on the selection made in the Collect Samples on Export chooser in the File/Folder Preferences. This chooser provides the following options:

- *Always*, the default setting, will copy files into the same folder as the clip, preset, or track without notification.
- When *Ask* is selected, Live provides a dialog box with options for copying files.
- *Never* means that samples will not be copied when saving.

5.10 Aggregated Locating and Collecting

Instead of having to deal with problems while you are in a creative mode, you might prefer putting aside some dedicated housekeeping time to solve all the problems in one go. Using

Live's File Manager, you can **find missing samples** and **collect external samples** not only for the current Live Set but also for:

- *The Library* – choose the Manage Files command from the File menu; then click the Manage Library button.
- *The current Live Project* – choose the Manage Files command from the File menu; then click the Manage Project button.
- *Any Live Project* –  (PC) /  (Mac) on a Project in the Live Browser, and choose the Manage Project option.
- *All Projects found in a specific folder (and its sub-folders)* –  (PC) /  (Mac) on a folder in the File Browser, and choose the Manage Projects command.
- *Any selection of Live Sets, Live Clips, Live Presets* –  (PC) /  (Mac) on the respective items in the File Browser, and choose the Manage Files command.



Remember to click the Collect and Save button at the bottom of the File Manager when you are finished. Otherwise your changes will be discarded.

5.11 Finding Unused Samples

Live's File Manager can find the unused samples in a Project for you. You can then review them and decide to delete them individually or collectively. When searching for “unused” samples, Live will inspect each sample in a project folder, checking if it is referenced by any of the Live Sets, Live Clips or device presets in the Project. If not, the sample is regarded as unused – *even if other Projects or programs still use it.*

To find the unused samples for the currently open Project, choose the Manage Files command from the File menu, click the Manage Project button, and then click on the triangular-shaped fold button next to “Unused Samples” to access a summary and the Show button. Clicking the Show button makes the File Browser list the unused samples; there, you can **preview the samples** and delete them if you like.

Note you can also find the unused samples from the Library: choose the Manage Files command from the File menu, then click the Manage Library button, and then see the Unused Samples section.

Last but not least, you can find the unused samples for all Projects found in a specific folder (and its sub-folders):  (PC) /  (Mac) on a folder in the File Browser and choose the Manage Projects command, then see the Unused Samples section. Live inspects each Project individually and labels a sample unused even if another Projects in the same folder does use that sample. *To prevent losses, you may want to first collect the samples into their respective Projects and then purge the Projects of unused samples.*

5.12 Packing Projects into Live Packs



Live's File Manager provides the option of packing a [Live Project](#) in Live Pack format for convenient archiving and transfer. To do this, choose the Manage Files command from the File menu, click the Manage Project button, and then click on the triangular-shaped fold button next to "Packing." Click the Create Live Pack button to bring up a file-select dialog where you can specify the name and location of a new Live Pack file. Creating a new Live Pack from a Project does not affect the Project. If you want the Project deleted, you can delete it using the File Browser.

Live employs lossless compression techniques to minimize the file size of Live Packs. Depending on the audio materials in a Project, this saves up to 50 percent in file size.

To unpack a Live Pack (i.e., to restore the original Live Project), double-click the Live Pack file (.alp), drag it into the Live main window, or locate it via the File menu's Install Live Pack command. Live will then request that you choose a location for the new Project. Note: Factory Live Packs (those provided by Ableton) will automatically be installed in the [Live Library](#).

5.13 File Management FAQs

5.13.1 How Do I Create a Project?

A Project is automatically created whenever you save a Live Set, except when you save it into the Library or a preexisting Project. You can also manually create a Project by clicking  (PC) /  (Mac) in the Browser and selecting Create Project from the context menu.

5.13.2 How Can I Save Presets Into My Current Project?

As long as you're working in a Project (meaning that you've saved your current Live Set), every device in the Device Browser will show a Current Project sub-folder. You can copy presets from other Browser locations to the current project by **Ctrl** (PC) / **Alt** (Mac)-dragging them. You can also save presets directly to the current project by dragging from the device's title bar and dropping into the Current Project. You can then use the File Management tools, collect any referenced samples, etc.

5.13.3 Can I Work On Multiple Versions of a Set?

If you'd like to work on different versions of the same Live Set, save them into the same Project. This will usually be the Project that was created when you saved the first version of the Live Set. If a Project contains multiple Live Sets it will only collect one copy of any samples used by the various versions, which can save disk space and help with organization.

5.13.4 Where Should I Save My Live Sets?



You can save Live Sets anywhere you want, but saving to the Library or pre-existing Project folders can cause problems, and should be reserved for special cases. You should only save Live Sets in the Library if you intend to use them as templates for other Live Sets. Likewise, you should only save a Live Set to an existing Project if it is somehow related to the Project – for example, an alternate version of a song that's already in the Project.

5.13.5 Where Should I Save My Live Clips?

If you'd like to have your Live Clips available in all of your Projects, create a Library sub-folder and save your clips there. You can also save clips anywhere else on your computer.

5.13.6 Can I Use My Own Folder Structure Within a Project Folder?

You can organize your files any way you want within a Project, but you'll need to use the File Manager to relink the files that you've moved around:

- 1) In Live's Browser or via your operating system, reorganize the files and folders within your Project folder.
- 2) Navigate to the Project folder in the Browser and choose Manage Project via the  (PC) /  (Mac) context menu.
- 3) If you've changed the original location of any samples used in the Project, the Missing Samples section of the File Manager will indicate this. Click the Locate button to search for the samples.
- 4) Since you know that your samples are all in the Project folder, unfold Automatic Search. Then enable the Search Project and Fully Rescan Folders options. Finally, click Go to initiate the search.
- 5) When searching is complete, click Collect and Save at the bottom of the File Manager to update the Project.

5.13.7 How Do I Export A Project to the Library and Maintain My Own Folder Structure?

If you export a Project to the Library, Live will look in the Library to see if the folder names there match those in your Project, and will create any missing folders as necessary. For example, if your Project folder contains samples in "Samples/My Samples," Live will look in the Library for a "Samples" folder (which it will find, because it's part of the standard Library) and then for a "My Samples" sub-folder (which it will not find, but will then create).

Chapter 6

Arrangement View

The *Arrangement View* displays the *Arrangement*, which contains music laid out along a song timeline, like a multitrack tape.

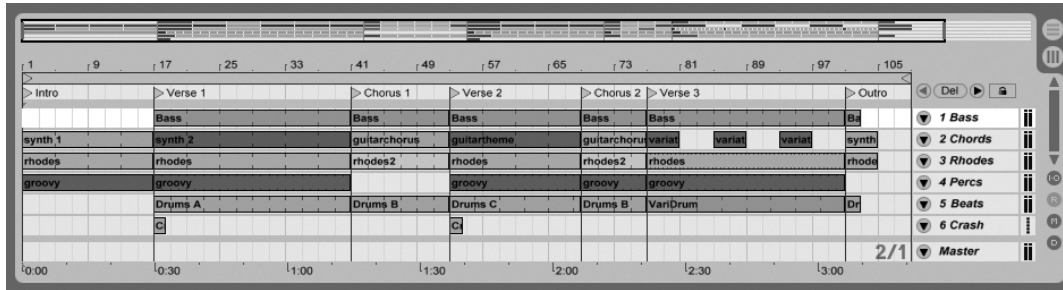

A Piece of Music in the Arrangement View.

The Arrangement View is a powerful editing tool that easily lets you combine and arrange MIDI, loops, sound effects, video and complete pieces of music.

6.1 Navigation

Live offers several fast methods for zooming and scrolling the Arrangement display:

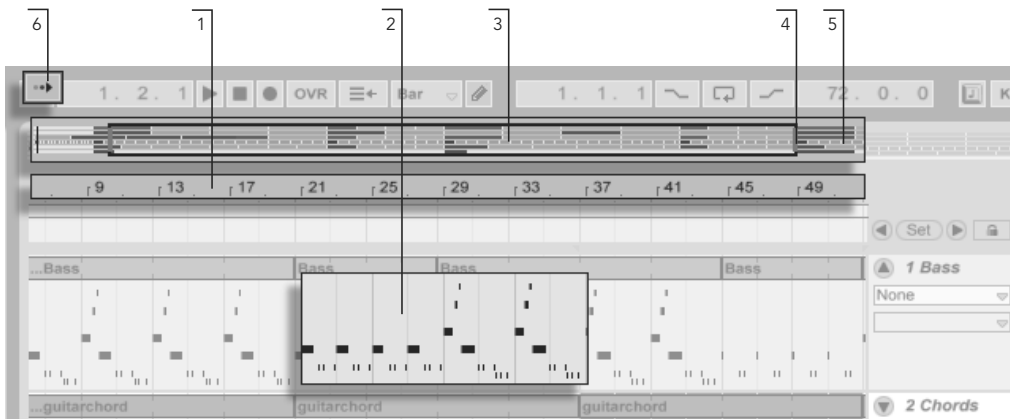

Navigating the Arrangement View.

1. To smoothly change the zoom level, click and drag vertically in the beat-time ruler at the top of the Arrangement View (you can also drag horizontally to scroll the display).
2. To zoom in and out around the current selection, use the computer keyboard's + and - keys. To "pan" the display, click and drag while holding the **Ctrl** / **Alt** (PC) / **⌘** / **Alt** (Mac) modifier. Double-clicking in the beat-time ruler also zooms to the current selection. If nothing is selected, double-clicking the beat-time ruler zooms out to show the entire Arrangement.
3. The Arrangement Overview is like a "bird's-eye view" of your music. It always shows the complete piece, from start to end. The black rectangular outline represents the part of the Arrangement that is currently displayed in the Arrangement display below. To scroll the display, click within the outline and drag left or right; to zoom out and in, drag up and down.
4. To change the displayed part of the Arrangement, drag the outline's left and right edges.
5. To see a specific part of the Arrangement in more detail, click on it in the Overview

and drag downwards to zoom in around that part. Note that you can also drag horizontally to scroll the display. Using this method, you can zoom and scroll to focus around any part of the Arrangement with just one mouse motion.

6. To have the Arrangement display follow the song position and scroll automatically, turn on the Follow switch, or use the Follow command from the Options menu.

6.2 Transport

There are a number of ways to control Live's transport with the computer keyboard and mouse:

1. You can start Arrangement playback by clicking the Control Bar's Play button, and stop playback by clicking the Stop button. Arrangement playback can also be toggled on and off by pressing the keyboard's space bar.



The Play and Stop Buttons in the Control Bar.

2. You can set the Arrangement playback position by clicking anywhere along the Arrangement to place the flashing insert marker. Double-clicking the Stop button will return the Arrangement play position to 1.1.1.

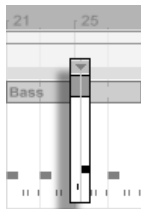

Arrangement Playback Begins from the Insert Marker.

To continue playback from the position where it last stopped, rather than from the insert marker, hold down the  modifier while pressing the space bar.

3. When Permanent Scrub Areas is enabled in Live's Look/Feel Preferences, clicking in the scrub area above the tracks will make playback jump to that point. The size of these jumps is quantized according to the Control Bar's Quantization

menu setting. While the mouse is held down over the scrub area, a portion of the Arrangement the size of the chosen quantization setting will be repeatedly played. With small quantization settings, or a setting of “None,” this allows you to scrub through the music.

When the Permanent Scrub Areas preference is off, you can still scrub by  - clicking anywhere in the scrub area or in the beat time ruler.

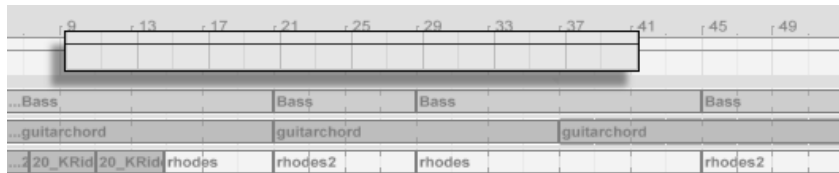



Scrubbing Arrangement Playback.

- The song position can be adjusted numerically using the Control Bar's Arrangement Position fields.



Setting the Play Position in the Arrangement Position Fields.

The Arrangement Position fields show the song position in bars-beats-sixteenths. To change the values:

- Click and drag up or down in any of these fields.
 - Click and type a number, then hit **Return**.
 - Click and decrement or increment the value with  and .
- Arrangement playback can be started at a particular point in one of your clips using the scrub area in the [Clip View](#).
 - Several Arrangement playback positions can be set using launchable [locators](#).

Note that any computer keyboard key or MIDI message can be mapped to the transport controls, as described in [the respective chapter](#).

6.3 Launching the Arrangement with Locators

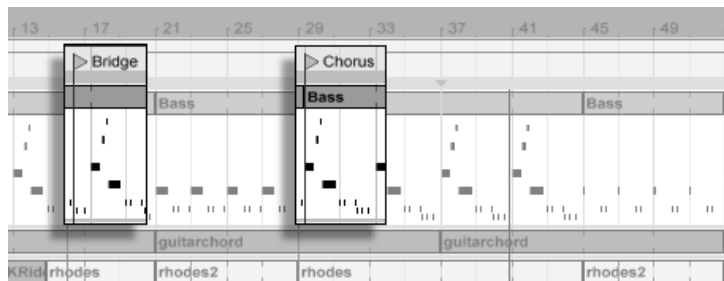

Using Locators to Launch Play in the Arrangement.

Locators can be set at any point in the Arrangement. This can be done in real time during playback or recording with the Set Locator button, and will be quantized according to the global quantization value set in the Control Bar. Clicking the Set Locator button when the Arrangement is not playing will create a locator at the insert marker or selection start. You can also create a locator using the context menu in the scrub area above the tracks or via the Create menu. Note that the position of a new locator is quantized according to the Control Bar's Quantization menu setting.

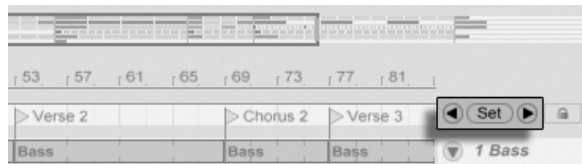

The Locator Controls.

You can recall (jump to) locators by clicking on them, or with the Previous and Next Locator buttons on either side of the Set button. Locators can also be recalled using [MIDI/key mapping](#). Note that locator recall is subject to quantization. Double-clicking a locator will select it and start Arrangement playback from that point.

After jumping to the first or last locator in the Arrangement, the Previous and Next Locator buttons will jump to the Arrangement start or end, respectively.

Locators can be moved by clicking and dragging, or with the arrow keys on your computer keyboard.

To name a locator, select it by clicking its triangular marker, and choose the Rename Edit

menu command (or use the **Ctrl** **R** (PC) / **⌘** **R** (Mac) shortcut). You can also enter your own **info text** for a locator via the Edit Info Text command in the Edit menu or in the locator's **I** (PC) / **Ctrl** **I** (Mac) context menu. Locators can be removed with your computer's **←** or **Delete** key, the Create menu, or the Delete Locator button.

Note that the locator **I** (PC) / **Ctrl** **I** (Mac) context menu offers a quick way of **looping playback** between two locators with its Loop To Next Locator command.

The locator **I** (PC) / **Ctrl** **I** (Mac) context menu's Set Song Start Time Here command can be used to overrule the default "play starts at selection" rule: when this command is checked, play starts at the locator.

6.4 Time Signature Changes

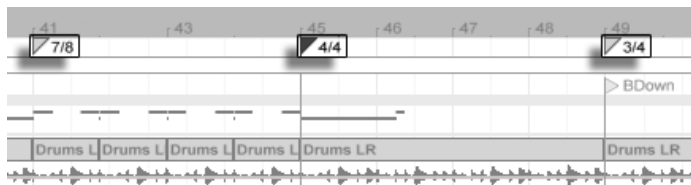

Time Signature Changes.

Live's time signature can be changed at any point in the Arrangement by using time signature markers. These can be added at the insert marker position via the Create menu, or anywhere below the beat-time ruler using the **I** (PC) / **Ctrl** **I** (Mac) context menu. Time signature markers appear just below the beat time ruler, but this marker area is hidden if a set contains no meter changes, freeing up additional space at the top of the Arrangement.



In many ways, time signature markers look and function like locators; they can be moved with the mouse or with your computer keyboard's arrow keys, and their value can be changed using the Edit menu's Edit Value command (or with the **Ctrl** **R** (PC) / **⌘** **R** (Mac) shortcut). They can be also be deleted using the **←** or **Delete** key, or via delete commands in the Edit and Create menus.

The time signature marker **I** (PC) / **Ctrl** **I** (Mac) context menu offers a number of features, including a Delete All Time Signature Changes command and options to **loop** or select the area up to the next time signature marker.

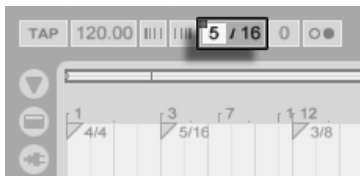
Any time signature with a one- or two-digit numerator and a denominator of 1, 2, 4, 8 or 16 can be used as a time signature marker value. The numbers must be separated by a delimiter such as a slash, comma, period, or any number of spaces. These marker values can also be set by adjusting the time signature fields in the Control Bar, either by typing in values or dragging the numerator and denominator sliders. This will change the time signature marker value at the current play location, and works either with the transport stopped or during playback. When the Arrangement contains time signature changes, the time signature editor displays an automation LED in the upper left corner.



The Time Signature Editor Can Change Time Signature Marker Values, and Shows an Automation LED.

Time signature markers are not quantized; they may be placed anywhere in the timeline, and their positioning is only constrained by the **editing grid**. This means that it is possible to place meter changes in “impossible” places - such as before the end of the previous measure. This creates a *fragmentary bar*, which is represented in the scrub area by a crosshatched region. Live is happy to leave these incomplete measures as they are, but if you’d like your Set to conform to the rules of music theory, you can use the two  (PC) /  (Mac) context menu options to “correct” incomplete bars.

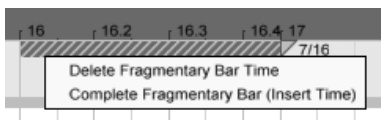

A Fragmentary Bar and its Resolution Options.

- *Delete Fragmentary Bar Time* deletes the duration of the fragmentary bar from the Arrangement, thereby moving any audio or MIDI on either side of the deleted area closer together in the timeline. The next time signature marker will now fall on a “legal” barline.
- *Complete Fragmentary Bar* inserts time at the beginning of the fragmentary bar, so that it becomes complete. The next time signature marker will now fall on a “legal” barline.

Please note that these resolution options affect *all* tracks - deleting and inserting time

changes the length of the entire Arrangement.

If you import a [MIDI file](#) into the Arrangement, you'll be given an option to import any time signature information that was saved with the file. If you choose to do this, Live will automatically create time signature markers in the correct places. This makes it very easy to work with complex music created in other sequencer or notation software.

6.5 The Arrangement Loop



The Control Bar's Loop Switch.

For Live to repeatedly play a section of the Arrangement, activate the *Arrangement loop* by clicking on the Control Bar's Loop switch.



The Loop Start Fields (Left) and the Loop Length Fields (Right).

You can set loop length numerically using the Control Bar fields: The left-hand set of fields determines the loop start position, while the right-hand set determines loop length.



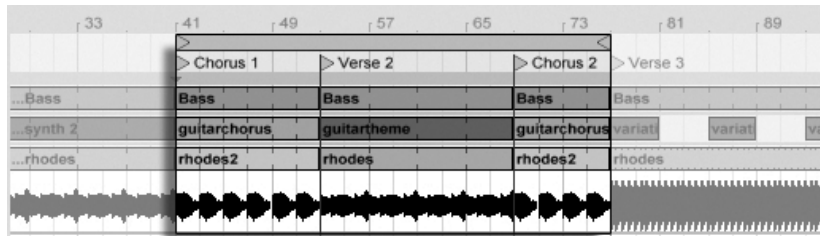



The Edit menu's Loop Selection command accomplishes all of the above at once: It turns the Arrangement loop on and sets the Arrangement loop brace to whatever timespan is selected in the Arrangement.





The Arrangement's Loop Brace.

The loop brace can be selected with the mouse and manipulated with commands from the computer keyboard:

- and nudge the loop brace to the left/right by the current [grid setting](#).

-  and  shift the loop brace left/right in steps the size of its length.
- The  (PC) /  (Mac) modifier used with the arrow left and right keys shortens or lengthens the loop by the current **grid setting**.
- The  (PC) /  (Mac) modifier with the arrow up and down keys doubles or halves the loop length.

You can also drag the Arrangement's loop brace: Dragging the left and right ends sets the loop start and end points; dragging between the ends moves the loop without changing its length.

The loop's  (PC) /  (Mac) context menu's Set Song Start Time Here command can be used to overrule the default "play starts at selection" rule: when this command is checked, play starts at the loop start.

6.6 Moving and Resizing Clips

A piece of audio or MIDI is represented in the Arrangement View by a clip sitting at some song position in one of Live's **tracks**.

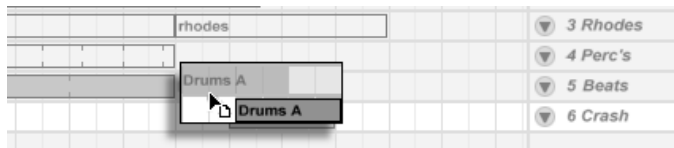

Moving a Clip.

Dragging a clip moves it to another song position or track.

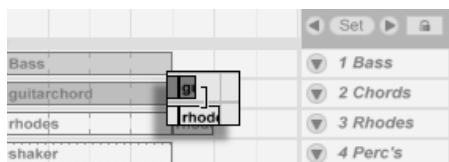

Changing a Clip's Length.

Dragging a clip's left or right edge changes the clip's length.

Clips snap to the **editing grid**, as well as various objects in the Arrangement including the edges of other clips, locators and time signature changes.

6.7 Audio Clip Fades and Crossfades



The beginning and end of audio clips in the Arrangement View have adjustable volume fades. Additionally, adjacent clips on the same audio track can be *crossfaded*.

To access the fades for an audio track's clips:

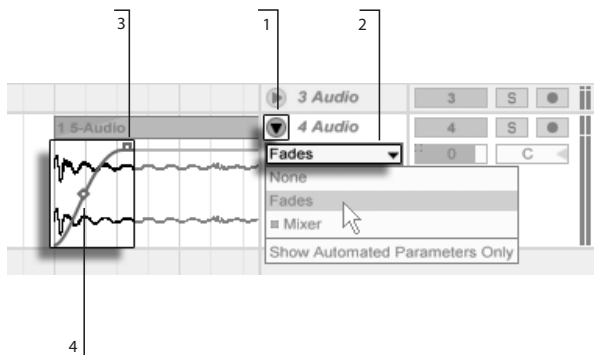

1. "Unfold" the track by clicking the ▼ button next to the track name.
2. Select "Fades" in the Fades/Device chooser.
3. Click and drag the fade handle to change the length of the fade.
4. Click and drag the slope handle to change the shape of the fade's curve.



Fades in the Arrangement View.

You can also set the length of a fade by **selecting a range of time within the clip** that includes the clip's beginning or end and executing the Create Fade command in the clip's  (PC) /  (Mac) context menu.

Adjacent audio clips can be crossfaded. Creating and editing crossfades is similar to creating and editing start and end fades:

- click and drag a fade handle over the opposite clip's edge to create a crossfade
- click and drag the slope handle to adjust the shape of the crossfade's curve
- select a range of time that includes the boundary between the adjacent clips and execute the Create Crossfade command from the  (PC) /  (Mac) context menu.

menu.

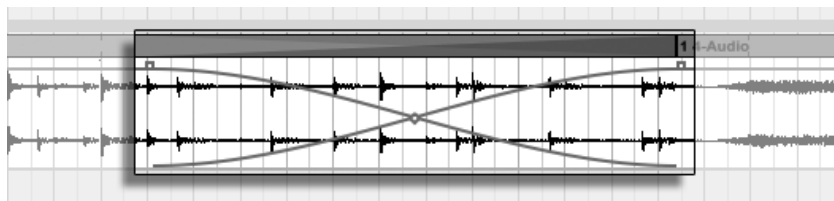

Crossfaded Clips.

Selecting a fade handle and pressing the **Delete** key deletes the fade, unless the Create Fades on Clip Edges option is enabled in the Record/Warp/Launch Preferences. In this case, pressing **Delete** returns the fade handle to a default length of 4 ms. With this option enabled, new clips in the Arrangement View will have these short “declicking” fades by default.

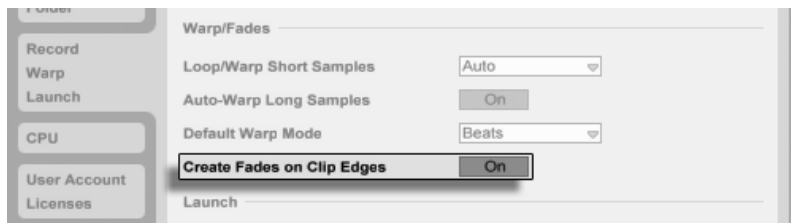

Automatically Create Short Fades At Clip Edges.

Another result of enabling the Create Fades on Clip Edges option is that adjacent audio clips will get automatic 4 ms crossfades. These can then be edited just like manually-created crossfades.

There are some limits to the length of fades and crossfades:

- Fades cannot cross a clip's loop boundaries.
- A clip's start and end fades cannot overlap each other.

When a fade handle is selected, a dotted red line will appear on the relevant clip to indicate the limit for that fade handle. This is especially helpful when editing crossfades, because one clip's loop boundary may be “hidden” under the other clip.

Note that fades are a property of clips rather than the tracks that contain them, and are independent of **automation envelopes**.

6.8 Selecting Clips and Time

With the exception of moving and resizing clips, Arrangement editing in Live is selection-based: You select something using the mouse, then execute a menu command (e.g., Cut, Copy, Paste, Duplicate) on the selection. This editing method lends itself to an efficient division of labor between the two hands: One hand operates the mouse or trackpad, while the other hand issues the keyboard shortcuts for the menu commands. The menu eventually is only used as a reference for looking up the keyboard shortcuts.

Here is how selection works:



- Clicking a clip selects the clip.
- Clicking into the Arrangement background selects a point in time, represented by a flashing insert mark. The insert mark can then be moved in time with the **←** and **→** keys, or between tracks via **↓** and **↑**. Holding **Ctrl** (PC) / **Alt** (Mac) while pressing the **←** and **→** keys snaps the insert mark to locators and the edges of clips in the selected track or tracks.
- Clicking and dragging selects a timespan.
- To access the time *within* a clip for editing, “unfold” its track by clicking the **▼** button next to the track name.



Adjusting an Unfolded Track's Height.

Clicking and dragging in the waveform display below the clip's horizontal strip allows you to select time within the clip. Notice that you can adjust the height of the unfolded track by dragging the split line below the Unfold Track button. Note that you can actually unfold all of your tracks at once by holding down the **Alt** (PC) / **Alt** (Mac) modifier when clicking the **▼** button.

- Clicking on the loop brace is a shortcut for executing the Edit menu's Select Loop command, which selects all material included within the loop.



- Holding  while clicking extends an existing selection in the same track or across tracks. You can also hold  and use the arrow keys to manipulate the selection.



























Clicking the Loop Brace to Select the Loop for Editing.

6.9 Using the Editing Grid



To ease editing, the cursor will snap to grid lines that represent the meter subdivisions of the song tempo. The grid can be set to be either zoom-adaptive or fixed.

You can set the width of both zoom-adaptive and fixed grid lines using the  (PC) /   (Mac) context menu available in either the Arrangement View track area or the Clip View display.

The following shortcuts to Options menu commands allow quickly working with the grid:

- Use   (PC) /    (Mac) to *narrow* the grid, doubling the density of the grid lines (e.g., from eighth notes to sixteenth notes).
- Use   (PC) /    (Mac) to *widen* the grid, halving the density of the grid lines (e.g., from eighth notes to quarter notes).
- Use   (PC) /    (Mac) to toggle *triplets* mode; this would, for instance, change the grid from eighth notes to eighth note triplets.
- Use   (PC) /    (Mac) to turn grid snapping on or off. When the grid is off, the cursor does not snap to meter subdivisions.
- Use   (PC) /    (Mac) to toggle fixed and adaptive grid modes.

The current spacing between adjacent grid lines is displayed in the lower right corner of the Arrangement View or Clip View.

You can hold down the  (PC) /  (Mac) modifier while performing an action to bypass grid snapping. If the grid is already disabled, this modifier will temporarily enable it.

6.10 Using the ...Time Commands

Whereas the standard commands like Cut, Copy and Paste only affect the current selection, their "... Time" counterparts act upon all tracks by inserting and deleting time. Any time signature markers within the selected region will also be affected.

- *Cut Time* cuts a selection of time from the Arrangement, thereby moving any audio or MIDI on either side of the cut area closer together in the timeline. This command reduces the length of your Arrangement by whatever amount of time you have cut. Note that the Cut Time command affects all tracks, not only the selected ones.

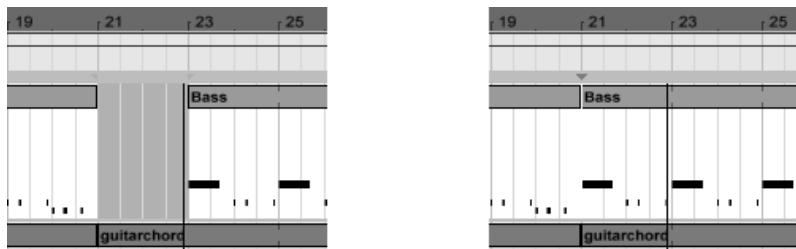

A Gap Between Clips Has Been Cut by First Selecting It, Then Executing the Cut Time Command.

- *Paste Time* places copied time into the Arrangement, thereby increasing its overall duration by the length of time you have copied.
- *Duplicate Time* places a copy of the selected timespan into the Arrangement, thereby increasing its overall duration by the length of the selection.
- *Delete Time* deletes a selection of time from the Arrangement, thereby moving any audio or MIDI on either side of the deleted area closer together in the timeline. This command reduces the length of your Arrangement by the amount of time you have deleted. Note that the Delete Time command affects all tracks, not only the selected ones.

- *Insert Silence* inserts as much empty time as is currently selected into the Arrangement, before the selection.

6.11 Splitting Clips

The Split command can divide a clip or isolate part of it.

To split a clip in two halves, do the following:

1. Unfold the track;
2. In the waveform or MIDI display, click at the position where you want the clip to be split;
3. Execute the Split command.

To isolate a part of a clip, do the following:

1. Unfold the track;
2. In the waveform or MIDI display, drag a selection over the part of the clip you want to isolate;
3. Execute the Split command to divide the original clip into three pieces.

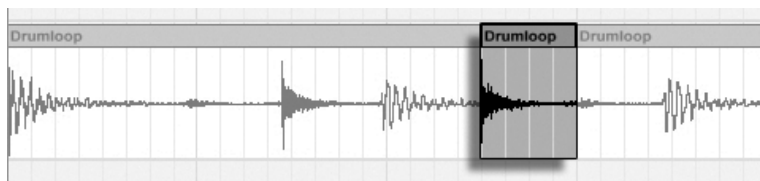

The Result of Splitting a Clip.

6.12 Consolidating Clips

The Consolidate command replaces the material in the Arrangement View selection with one new clip per track. This is very useful for creating structure.



Consolidating Several Clips Into a New Clip.

Suppose you have, by editing or improvising, come up with a layout of clips that sound good in **Arrangement Loop mode**. Selecting that part of the Arrangement, for instance by using the Edit menu's Select Loop command, and then executing the Consolidate command creates a new clip that can be treated as a loop. You can now, for instance, drag the clip edges to create more repetitions. You might also want to drag the new loop via the Session View selector into a Session View slot for real-time arrangement purposes.

When operating on audio clips, Consolidate actually creates a new sample for every track in the selection. The new samples are essentially recordings of the time-warping engine's audio output, prior to processing in the track's effects chain and mixer. Hence, the new sample incorporates the effects of in-clip attenuation, time-warping and pitch shifting, and of the respective **clip envelopes**; however, it does not incorporate the effects. To create a new sample from the post-effects signal, please use the **Export Audio/Video command**.

The new samples can be found in the current Set's **Project folder**, under Samples/Processed/Consolidate. Until the Set is saved, they remain at the location specified by the **Temporary Folder**.

Chapter 7

Session View

In Live's **Arrangement View**, as in all traditional sequencing programs, everything happens along a fixed song timeline. For a number of applications, this is a limiting paradigm:

- When playing live, or when DJing, the order of pieces, the length of each piece and the order of parts within each piece is generally not known in advance.
- In the theatre, sound has to react to what happens on stage.
- When working along with a piece of music or a film score, it can be more efficient and inspirational to start with an improvisation, which is later refined into the final product.

This is exactly what Live's unique *Session View* is for.

7.1 Session View Clips

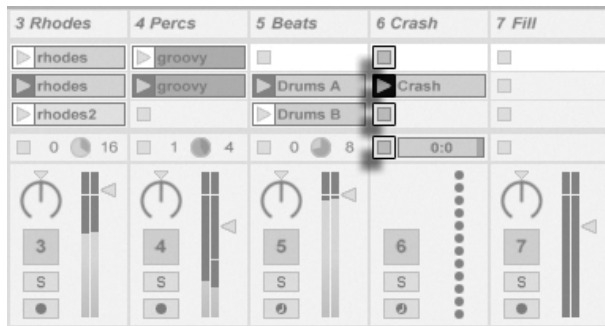

The Controls for a Session View Clip.

1. Each clip in the Session View has a triangular button at the left edge. Click the button with the mouse to “launch” clip playback at any time, or pre-select a clip by clicking on its name, and launch it using the computer’s `Return` key. You can then move on to the neighboring clips using the arrow keys. Please refer the manual section on [clip launch settings](#) for details on how to customize this behavior.
2. Click on a square Clip Stop button to stop a running clip, either in one of the track’s slots, or in the *Track Status field* below the Session grid.

Clips can be [controlled remotely](#) with the computer keyboard or a MIDI controller. They can even be mapped to MIDI note ranges so that they play chromatically.

Clips can be played at any time and in any order. The layout of clips does not predetermine their temporal succession; the Session grid offers random access to the clips it contains.

Notice that, even if you stop playback for a Session View clip, the Play button in the Control Bar will remain highlighted, and the Arrangement Position fields will continue running. These fields keep a continuous flow of musical time going, so that you can always know your position in song time during a live performance or while [recording into the Arrangement](#), regardless of what your individual Session clips are doing.

You can always return the Arrangement Position fields to 1.1.1 and stop playback for the entire Live Set by pressing the Control Bar’s Stop button twice.



The Arrangement Position Fields and the Stop Button.

Slots in **Group Tracks** show a shaded area to indicate that at least one of the contained tracks contains a clip at that location. The color of the shading is the color of the left-most clip in the group. These group slots also contain launch buttons which will launch all of the respective clips. Group slots which have no corresponding clips contain stop buttons. Clicking in any group slot selects all of the clips it refers to.



Group Slots and Group Launch Buttons.

7.2 Tracks and Scenes

Each vertical column, or **track**, can play only one clip at a time. It therefore makes sense to put a set of clips that are supposed to be played alternatively in the same columns: parts of a song, variations of a drum loop, etc.

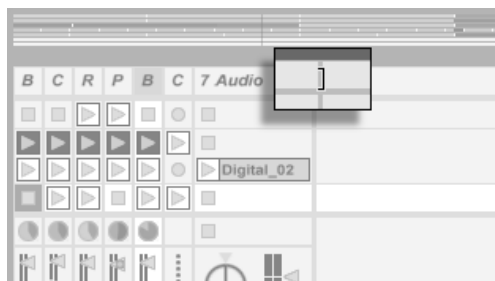

Resized Session View Tracks.

For convenient access to more clips at once, you can resize Session View tracks by clicking and dragging at the edges of their title bars. Tracks can be narrowed this way so that only Clip Launch buttons and essential track controls are visible.

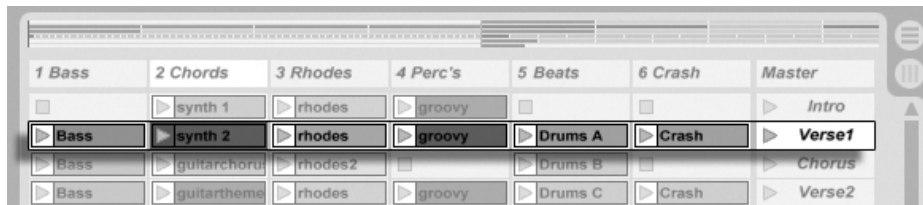

A Scene in the Session View.

The horizontal rows are called scenes. The *Scene Launch* buttons are located in the rightmost column, which represents the **Master track**. To launch every clip in a row simultaneously, click on the associated Scene Launch button. This can be very useful in organizing the live performance of a song with multiple parts.

The scene below a launched scene will automatically be selected as the next to be launched unless the Select Next Scene on Launch option in the Launch Preferences is set to “Off.” This allows you to trigger scenes from top to bottom without having to select them first. Computer keys or a MIDI controller can be used to **launch scenes and scroll between them**.

Scenes can be renamed using the Rename command in the Edit menu or the (PC) / (Mac) context menu. One can quickly rename several scenes by executing the Rename command and using the computer’s Tab key to move from one scene to the next. You can also enter your own **info text** for a scene via the Edit Info Text command in the Edit menu or in the scene’s (PC) / (Mac) context menu. The context menu also contains a color palette where you can choose a custom scene color.

Scenes can be reordered by drag-and-drop. Multiple adjacent or nonadjacent scenes can be selected at once by -clicking or -clicking, respectively. If you drag a selection of nonadjacent scenes, they will be collapsed together when dropped. To move nonadjacent scenes without collapsing, use + / instead of the mouse.

Scene names can be both descriptive and functional; if Live detects a viable tempo and/or time signature as part of a scene name, the project will automatically adjust to these parameters when the scene is launched. To assign a tempo to a scene, select the scene and rename it with a viable tempo (e.g., “96 BPM”). Any tempo can be used, as long as it is within the range allowed by Live’s Tempo control (20–999 BPM). To assign a time signature to a scene, rename the scene with a meter in the form of “x/y” (e.g., “4/4”). Any time signature can be used, provided it has a numerator between 1 and 99 and a denominator with a beat value of 1, 2, 4, 8 or 16.

Tempo and time signature changes can coexist within a single scene name, and can appear in any position as long as they are separated from each other by at least one character. For example, “2/4+108 BPM”, “72 BPM;7/8” and “60 BPM Chorus 3/4” are all scene names that will cause simultaneous meter and tempo changes.



These Scenes Will Change the Tempo and Time Signature.

7.3 The Track Status Fields

You can tell a track’s status by looking at the Track Status field just above the active track’s mixer controls:



A Track Playing a Looping Session Clip...

The pie-chart icon in a clip track represents a **looping Session clip**. The number to the right of the circle is the loop length in beats, and the number at the left represents how many times the loop has been played since its launch. A pie-chart without numbers appears in the Track Status field for a **Group Track** if at least one clip in a contained track is currently playing.

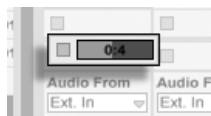

... A One-shot Session Clip...

The progress-bar icon represents a one-shot (non-looping) Session clip. The value displays the remaining play time in minutes:seconds.



... Monitoring the Input...

A microphone icon appears in an audio track that is set to **monitor its input**. A keyboard icon appears in a MIDI track under these same circumstances.



... Playing the Arrangement.

If the track is playing clips from the Arrangement, a miniature display representing the Arrangement clips being played appears.

7.4 Setting Up the Session View Grid

Clips arrive in the Session View by being **imported from the File Browsers** or through **recording**.

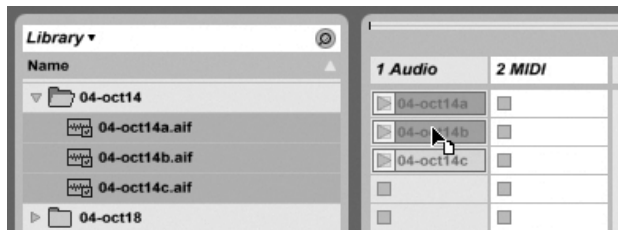

Dropping Multiple Clips Into the Session View.

If you are dragging multiple clips into the Session View, Live defaults to arrange them vertically, in one track. Hold down **Ctrl** (PC) / **⌘** (Mac) prior to dropping them so as to lay the clips out in one scene.

Clips can be moved around the Session grid by drag-and-drop. To move several clips at once, select them by using the **⇧** - or **Ctrl** (PC) / **⌘** (Mac)-modifier before dragging. You can also click into an empty slot and “rubber-band” select from there.

7.4.1 Select on Launch

By default, clicking a Session View clip's Launch button also selects the clip, since you will typically want the Clip View to show the newly launched clip. However, some power-users don't want the current focus (e.g., a return track's devices) to disappear just because a clip has been launched, especially when starting a clip in order to try it with the return track device settings. Turn off the Select on Launch option from the Launch Preferences if you prefer the view to remain as is when you launch clips or scenes.

7.4.2 Removing Clip Stop Buttons



Slots Without Clip Stop Buttons.

You can add and remove Clip Stop buttons from the grid using the Edit menu's Add/Remove Stop Button command. This is useful for pre-configuring the scene launch behavior: If, for instance, you don't want scene 3 to affect track 4, remove the scene 3/track 4 Stop button.

7.4.3 Editing Scenes

In addition to the standard Edit menu commands such as cut, copy, paste and duplicate, there are two useful commands in the Create menu that apply specifically to scenes:

- *Insert Scene* inserts an empty scene below the current selection.
- *Capture and Insert Scene* inserts a new scene below the current selection, places copies of the clips that are currently running in the new scene and launches the new scene immediately with no audible interruption. This command is very helpful when developing materials in the Session View. You can capture an interesting moment as a new scene and move on, changing clip properties and trying clip combinations.

7.5 Recording Sessions into the Arrangement

Your Session View playing can be recorded into the Arrangement, allowing for an improvisational approach to composing songs and scores.



The Control Bar's Record Button.

When the Record button is on, Live logs all of your actions into the Arrangement:

- the clips launched;
- changes of those **clips' properties**;
- changes of the mixer and the devices' controls, also known as **automation**;
- tempos and time signature changes, if they are included in the names of launched scenes.

To finish recording, press the Record button again, or stop playback.

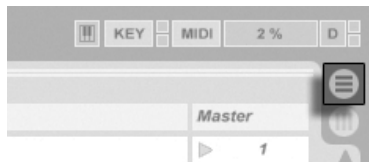

The Arrangement Selector.

To view the results of your recording, bring up the Arrangement View. As you can see, Live has copied the clips you launched during recording into the Arrangement, in the appropriate tracks and the correct song positions. Notice that your recording has not created new audio data, only clips.

The Session clips and the Arrangement clips in one track are mutually exclusive: Only one can play at a time. When a Session clip is launched, Live stops playing back the Arrangement in favor of the Session clip. Clicking a Clip Stop button causes the Arrangement playback to stop, which produces silence.



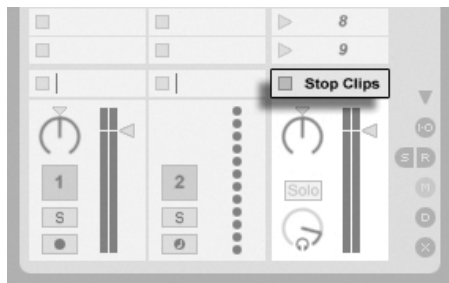

The Back to Arrangement Button.

Arrangement playback does not resume until you explicitly tell Live to resume by clicking the Back to Arrangement button, which lights up to remind you that what you hear differs from the Arrangement.



The Stop All Clips Button.

To disable all Arrangement clips simultaneously, click on the Stop All Clips button in the Master Track Status field. The clips in the Arrangement and in the Session View exist independently from one another, which makes it easy to improvise into the Arrangement over and over again until it's right.

Furthermore, you can move clips not only within the Session grid, but also from the Session View to the Arrangement and vice versa by using Copy and Paste, or by dragging clips over the  or  selectors.

When pasting material from the Arrangement into the Session View, Live attempts to preserve the temporal structure of the clips by laying them out in a matching top-to-bottom order. Moving through the scenes from the top down, you can reconstruct the original arrangement. This is useful for taking a composed piece of music back to the improvisational stage.

Chapter 8

Clip View

The *Clip View* is where clip properties can be set and adjusted.

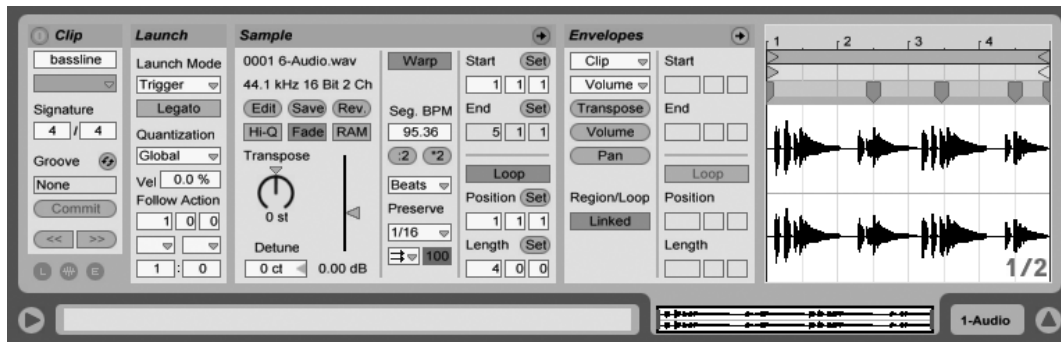

The Clip View.

The Clip View is opened by clicking on the Clip Overview or double-clicking a clip in the Session or Arrangement View.

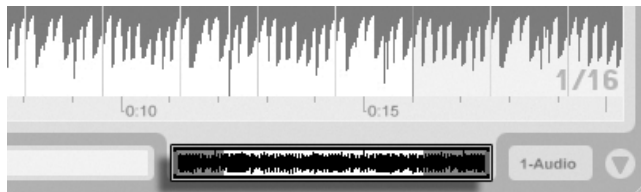

Clicking the Clip Overview Opens the Clip View.

In the Session View, clicking on a Track Status Field opens the Clip View for editing the clip that is currently running in the track.



Clicking a Session View Track Status Field Opens the Clip View.

The properties of more than one clip can be edited collectively in the Clip View as a multi-selection. To create a multi-selection, click and drag from an empty clip slot to highlight the clips, or select one clip and use the **Ctrl** (PC) / **⌘** (Mac) or **⇧** modifiers to add to your selection. The properties available in the Clip View for a multi-selection depend on the contents of the clips; generally only properties which the clips have in common are shown.

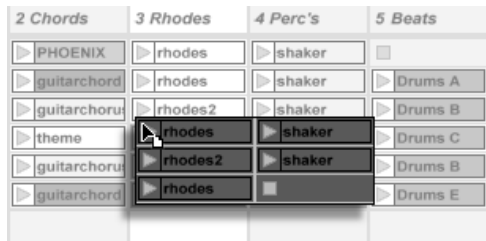

Creating a Clip Multi-Selection.

Controls such as sliders and knobs behave slightly differently when they are part of a multi-selection. If the clips in a multi-selection have differing values for any particular knob or slider parameter (clip transposition, for example), the *range* of these values will be displayed and can be adjusted with the control. Dragging the knob or slider to its absolute maximum or minimum value will make the clips' settings thereafter identical, adjustable as a single value.

MIDI clips and audio clips in Live have different sets of properties and, consequently, do not share the same set of Clip View controls. The two types of clips do have the following

in common:

- The *Clip box* contains basic clip settings.
- The *Envelopes box* and the *Envelope Editor* manage the clip's envelopes, which are used to modulate the effects, mixer, and clip or MIDI controls. Clip envelopes and their associated Clip View components are covered in detail in a [separate manual chapter](#).
- The *Launch box* controls clip launch behavior and, as such, only appears for Session View clips. Setting Session View clip launch properties is covered in detail in a [separate manual chapter](#).

Audio clips have these additional Clip View controls:

- The *Sample Display* toggles with the Envelope Editor on the right-hand side of the Clip View, and controls Live's [sample-warping capabilities](#) and [clip playback settings](#).
- The *Sample box* contains settings pertaining to how the clip plays its sample and displays it in the Sample Display.

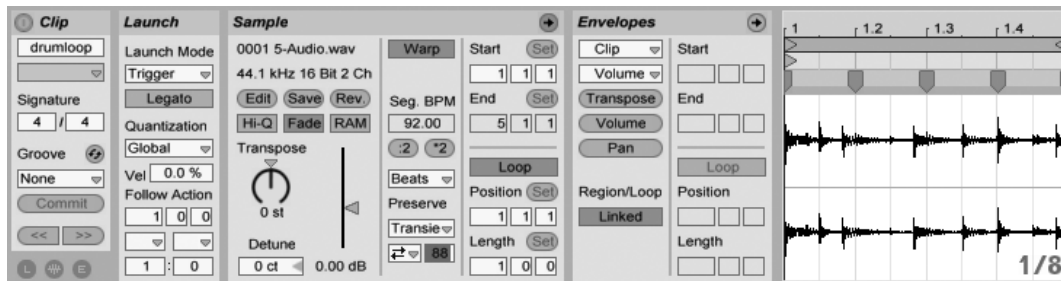

The Clip View for an Audio Clip.

MIDI clips have these additional Clip View controls:

- The *MIDI Editor* toggles with the Envelope Editor on the right-hand side of the Clip View, and allows [editing and creating MIDI notes and velocities](#).
- The *Notes box* contains settings pertaining to how Live plays a MIDI clip and what it displays in the MIDI Editor.



The Clip View for a MIDI Clip.

To make best use of the screen real estate, you can show or hide the Launch, Envelopes, and Sample or MIDI boxes using the Clip View Box selector in the Clips box. You can also toggle between the Sample Display/MIDI Editor and the Envelope Editor by clicking in the title bars of the Sample/Notes box and the Envelopes box, respectively.



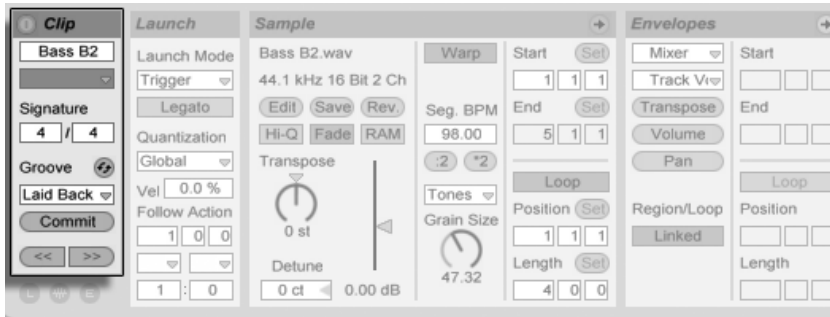

The Clip View Box Selector Shows and Hides Various Clip View Components.

8.1 The Clip Box





The Clip Box.

8.1.1 Clip Activator Switch

Using this switch, you can deactivate a clip so that it does not play when launched in the Session View or during Arrangement playback. Clips can also be activated/deactivated directly from the Session or Arrangement View with their  (PC) /  (Mac) context menus.

8.1.2 Clip Name and Color

The Clip Name field allows naming the clip. By default, a clip's name matches the name of the file it references but, in general, the clip name is independent from the file name.

You can also rename a clip by selecting it in the Session grid or Arrangement View and using the Rename command in the Edit menu or the clip's  (PC) /  (Mac) context menu. This method also allows you to create your own **info text** for the clip via the Edit Info Text command.

Renaming an audio clip does not rename the referenced sample file. To rename a file, select it in Live's File Browsers, and then choose the Edit menu's Rename command.

The Clip Color chooser allows choosing a clip color.

8.1.3 Clip Signature

Using the Clip Signature fields, you can specify the time signature of a MIDI or audio clip. This setting is relevant only for display; it does not affect playback. Please note that Clip Signature is completely separate from the project's time signature, and can be set independently for each clip. This makes it easy to create complex polymetric textures by simultaneously triggering clips with different meters and/or loop lengths.

8.1.4 Clip Groove Chooser

The Clip Groove chooser selects the groove used for the clip from the grooves available in the [Groove Pool](#).



The Clip Groove Chooser.

The “Open Groove Pool” entry in this chooser can be used to open the Groove Pool if it is closed. If you want to quickly try out a variety of grooves, you can enable the [Hot-Swap](#) button above the chooser and then step through the grooves in the Browser while the clip plays.

The Commit button under the chooser “writes” the current groove settings to the clip and disables the assigned groove. If the groove uses the Velocity parameter, committing on an audio clip will create a volume [Clip Envelope](#) in order to convert the groove's velocity information into audio volume changes. Note that this will overwrite any volume Clip Envelope that was already in the clip.

8.1.5 Clip Offset and Nudging

To jump within a playing clip in increments the size of the global quantization period, you can use the Nudge buttons in the Clip box.



Using the Nudge Buttons to Jump Through a Clip.

These buttons can also be **mapped to keys or MIDI controllers**. In MIDI Map Mode, a scrub control will appear between the Nudge buttons and can be assigned to a rotary encoder wheel for continuous scrubbing.



The Scrub Control in MIDI Map Mode.

With quantization set to values less than one bar, it is easy to offset clip playback from Live's master clock by launching clips, using the Nudge buttons or **scrubbing within the clip**.

8.2 The Sample Box

8.2.1 Warp Controls

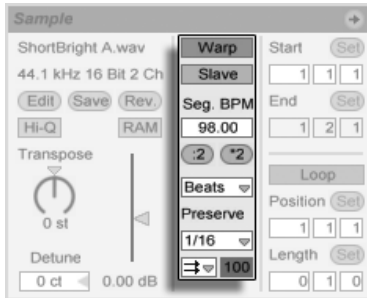

The Sample Box Warp Controls.

When the Warp switch is off, Live plays the sample at its original, “normal” tempo, irrespective of the current Live Set tempo. This is useful for samples that have no inherent rhythmic structure: percussion hits, atmospheres, sound effects, spoken word and the like. Turn the Warp switch on to play rhythmically structured samples (such as sample loops, music recordings, complete music pieces, etc.) in sync with the current song tempo.



The Control Bar's Tempo Field.

To verify this, note that a warped sample’s speed follows the tempo as you change the Control Bar’s Tempo control.

Live offers a number of controls to adjust the time-warping engine for **optimal stretching quality**. For accurate warping, Live needs to know the sample’s metrical structure. For properly prepared loops, tempo and duration are calculated automatically; most of the time this is accurate enough that the sample is immediately ready for use in Live. For other samples, you may have to **provide some hints**. We will examine these topics thoroughly in the **Tempo Control and Warping** chapter.

8.2.2 Sample Loop/Region and Display

Zooming and Scrolling

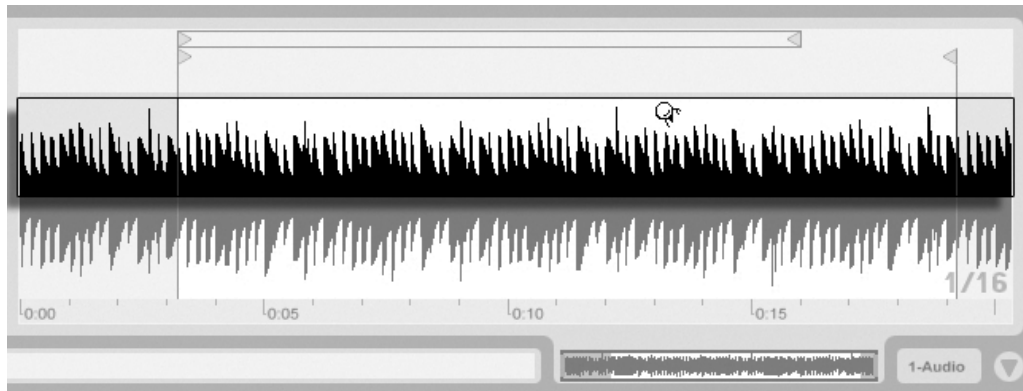

The Clip Zoom/Scroll Area.

Zooming and scrolling in the Sample Display work much like they do in the [Arrangement View](#). When Warp is disabled, zooming and scrolling can be done anywhere in the Sample Display. When Warp is enabled, however, scrolling only happens in the beat-time ruler and the bottom half of the waveform.

Click and drag vertically in these areas to smoothly change the zoom level, and horizontally to scroll the display.

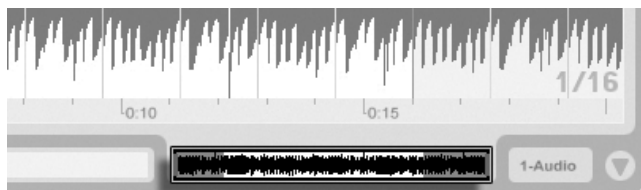

The Clip Overview.

The Clip Overview provides additional zoom/scrolling functionality. It always shows the complete clip, from start to end. The black rectangular outline represents the part of the clip that is currently displayed. You can click within the outline and drag horizontally or vertically to scroll or zoom.

To have the Sample Display follow the play position and scroll automatically, turn on the Follow switch, or use the Follow command from the Options menu.



The Follow Switch.

Playing and Scrubbing Clips

The section of the sample that plays when a clip is launched is set with the clip's region and **loop controls**. An unlooped clip will play from its start marker to its end marker or until it is stopped.

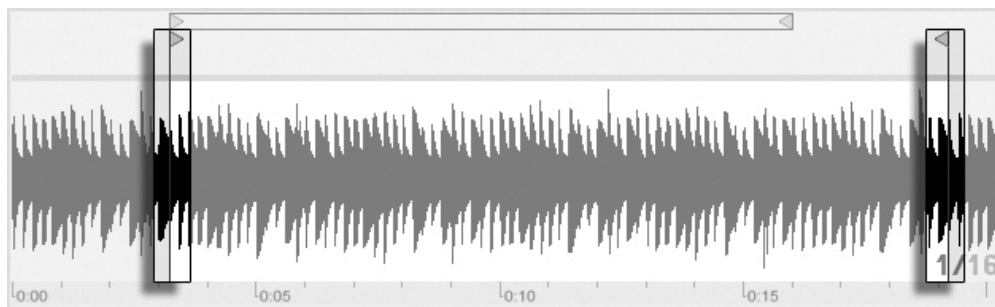

The Clip Start and End Markers.

These markers can be clicked and dragged to new positions in the Sample Display, or they can be moved with the **←** and **→** keys. To move the entire clip region (i.e., both the start and end markers), select the start marker, hold down **⌘**, and use the arrow keys.

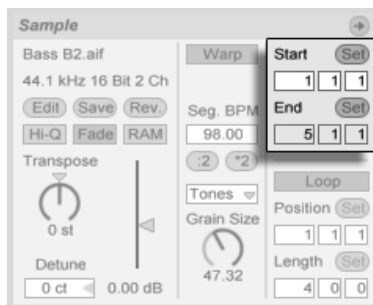

Using Clip Start and End Controls to Change Clip Length.

You can also adjust the clip start and end numerically using the respective value fields to the left of the Sample Display. For warped clips, these fields display values as bars-beats-sixteenths; for unwarped clips, the display is in minutes-seconds-milliseconds. Notice that you can use the Set buttons here to place the markers during playback. Setting markers this way is quantized according to global quantization.

When Permanent Scrub Areas is enabled in Live's Look/Feel Preferences, clicking in the lower half of the waveform or in the beat-time ruler will make clip playback jump to that point.

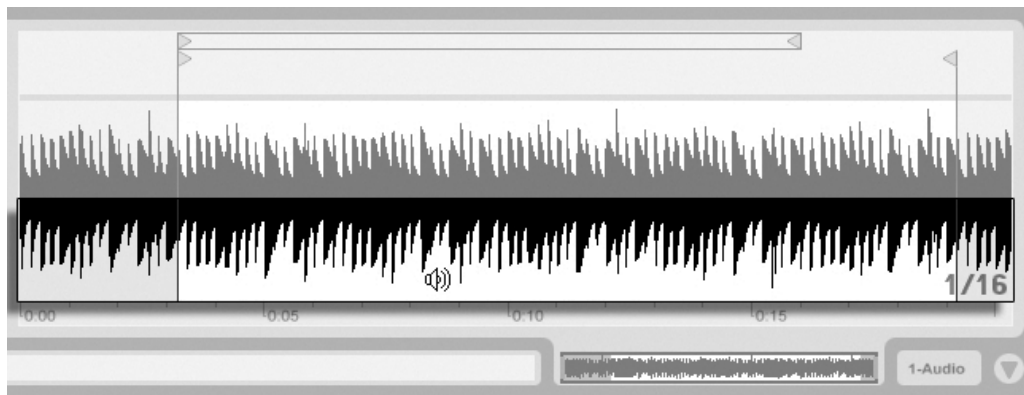

The Clip Scrub Area.

The size of this jump is quantized by the global quantization setting, which can be quickly changed using the **Ctrl** + **6** (PC) / **Cmd** + **6** (Mac), **7**, **8**, **9** and **0** shortcuts. While the mouse is held down over the scrub area, a portion of the clip the size of the chosen quantization setting will be repeatedly played. With small quantization settings, or a setting of "None," this allows you to scrub through the music.

When the Permanent Scrub Areas preference is off, you can still scrub by **Cmd**-clicking anywhere in the scrub area or in the beat time ruler.

Looping Clips

To have the clip play as a (potentially infinite) loop, turn on the *Loop* switch. Note that the *Warp* switch must be activated before the *Loop* switch is accessible, as unwarped clips

cannot be looped.

You can click and drag to change the position and length of the *loop brace* in the Sample Display, or you can type exact values into the Loop Length and Position fields to the left of the display.

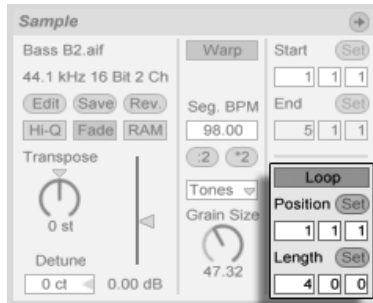

The Clip Loop Controls.

The loop brace can be selected with the mouse and its position changed with commands from the computer keyboard:

- and nudge the loop brace to the left/right by the current **grid setting**.
- and shift the loop brace left/right in steps the size of its length.
- (PC) / (Mac) shortens or lengthens the loop brace by the current **grid setting**.
- (PC) / (Mac) doubles or halves the loop length.

Regardless of the position of the loop brace, clip play will begin at the position marked by the start marker, which means you can set up the clip to run into a loop.

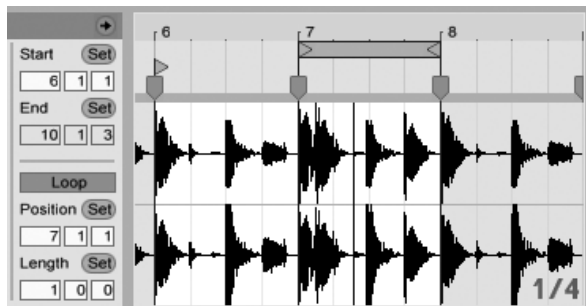

Setting the Clip to Run Into a Loop.

The Loop Length and Position fields are equipped with Set buttons, which can be used to create loops spontaneously during playback:

- Playing the clip and then clicking the Set Loop Position button moves the beginning of loop to the current playback position (rounded to the global quantization setting) and engages the loop. Then, clicking the Set Loop Length button moves the end of the loop to the current playback position. This lets you capture the music in a loop on the fly.
- While the loop is still off, you can click the Set Loop Length button to set the loop to end at the current playback position without changing its preset length. This simultaneously activates looping.

The Set buttons, the Loop switch, the loop brace and the start/end markers can all be [mapped to MIDI controls](#). You could, for example, use a rotary encoder to move the loop through a sample in increments the size of the chosen quantization interval.

8.2.3 Clip Pitch and Gain

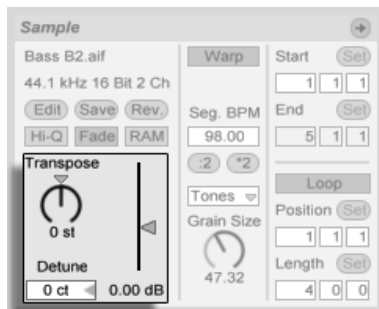

The Clip Pitch and Gain Controls.

The Transpose control shifts the clip pitch in semitones.

The Detune field fine-tunes the clip in cents (100 cents = one semitone).

The Clip Gain slider, calibrated in dB, changes the clip gain.

8.2.4 Destructive Sample Editing

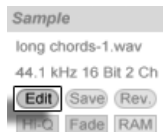

The Launch Sample Editor Button.

The Edit button opens the sample in an external sample editing application, which you can specify in the File/Folder Preferences. To process a sample in an external program, you have to stop Live's playback. When you return to Live, the edited version of the sample will be played back. The current set of Warp Markers is retained only if the sample length remains the same as it did prior to editing. Remember that changes made to one sample may affect other clips that play the same sample.

8.2.5 Saving Default Clip Settings with the Sample

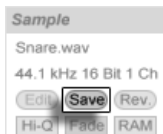

The Save Default Clip Button.

The Save Default Clip button saves the current clip's settings with the sample. Once saved, Live will restore the current clip settings whenever you drop the sample into a Live Set. This is especially useful with regards to the Warp Markers, which have to be set correctly for Live to play long files in sync. Note that you can use the Save button without affecting any existing clips; Save just saves default settings for future clips using this sample.

The clip data becomes part of the [analysis file](#) that accompanies the sample.

Note that storing default clip settings with the sample is different from saving the clip as a [Live Clip](#), which also saves devices and device settings.

8.2.6 High Quality Interpolation

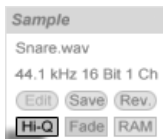

The High Quality Switch.

If the High Quality switch is on, Live uses an advanced sample-rate conversion algorithm that provides better sound quality at the expense of a higher [CPU load](#). Samples processed with the Hi-Q algorithm generate less distortion, particularly at high frequencies, when transposing a sample and/or matching an imported sample's sampling rate to the system's sampling rate. With this mode enabled, samples can be transposed roughly 19 semitones in either direction before aliasing is likely to be audible.

Note: As of Live 7, the Hi-Q mode uses an algorithm that produces even smaller audible artifacts than in previous versions. Although we think this has greatly improved sound quality, any Sets made in older versions that used Hi-Q mode may now sound different. For this reason, we have provided a Legacy Hi-Q Mode option, which is enabled by default in

the Options menu whenever you load an old Set that has Hi-Q enabled for any clips. Simply disable this option if you wish to use the new mode.

8.2.7 Clip Start and End Fades

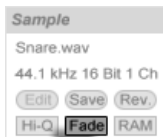

The Clip Fade Switch.

The Clip Fade switch, when enabled, applies a short fade to the clip start and end to avoid clicks at the clip edges. The length of the fade is signal-dependent and ranges from 0-4 milliseconds.

This switch is only available for clips in Session View. In Arrangement View, clip fades are adjusted via [envelopes](#).

The Clip Fade switch is on by default for all new clips when the Create Fades on Clip Edges option is enabled in the Record/Warp/Launch Preferences.

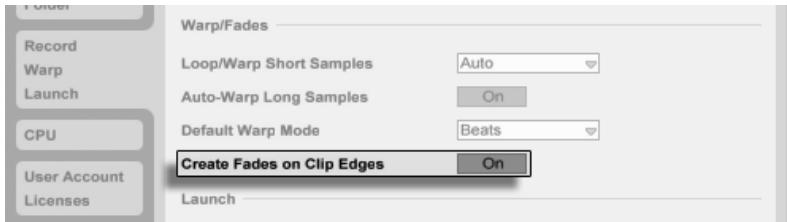

Automatically Create Short Fades At Clip Edges.

8.2.8 Clip RAM Mode

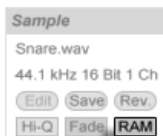

The RAM Mode Switch.

If the RAM Mode switch is on, Live is loading the audio referenced by the clip into the computer's memory rather than reading it from disk in real time. RAM Mode can help with these problems:

- Your computer's hard disk is too slow to deliver audio for as many tracks as desired in real time. For more information on disk-related problems, please refer to [Managing the Disk Load](#).
- You are experiencing audio dropouts when playing clips in [Legato Mode](#).

Use RAM Mode with care, as RAM is usually a scarce resource. Your computer is using the hard disk for swapping out RAM contents that have not been used in a while. The more clips you are running in RAM Mode, the higher the likelihood for them to be swapped out. Live can handle disk overloads more gracefully than swapped-out audio arriving late: Disk overloads result in unwanted mutes, whereas RAM overload results in both mutes and rhythmical "hiccups."

8.2.9 Reversing Samples

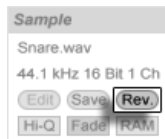

The Reverse Button.



This function creates a new sample by reversing the sample referenced by the current clip. It then reapplies the old clip's settings (according to some rules that we will explain in a moment), and replaces the original sample with the reversal in the Clip View. The new sample can be found, after saving the Live Set, in the Set's [Project folder](#), under Samples/Processed/Reverse. Until the Set is saved, new samples remain at the location specified by the [Temporary Folder](#).

There are a few rules for the reversing process. First, any [Warp Markers](#) will remain fixed to their positions *in the sample*. This means that a Warp Marker on the downbeat of the second bar of a clip will end up on the downbeat of the second-to-last bar after reversal. Clip loop/region settings are similarly flipped. Second, [clip envelopes](#) remain fixed to their position *in time*. Therefore, a mixer volume envelope that lowers the volume of the first half of a clip will continue to do exactly that after reversal.

The reversal process is quite fast (about as fast as copying), but for very long samples it might take a little time. When this is the case, the Status Bar in the lower portion of the Live screen will give you a progress display, and further actions in the program will be temporarily locked (though running clips will continue to play). You can play the reversed clip and perform other actions in the program as soon as Live begins to draw the new waveform into the Sample Display. Once a sample is reversed, a link to the reversed sample will be maintained until you quit the program, and reversing the same clip again (or a copy) will be instantaneous.







It is not recommended that you reverse clips in a live performance situation, as a slight glitch can sometimes occur while Live reapplies the warp and loop settings.

8.2.10 Cropping Audio Clips

The Sample Display's  (PC) /   (Mac) context menu includes the Crop Sample command. This function creates, similarly to the [Reverse function](#), a new sample by copying the one currently in use - but only the excerpt that is actually used plus a 50 millisecond safety margin on both ends. The new sample can be found, after saving the Live Set, in the Set's [Project folder](#), under Samples/Processed/Crop. Until the Set is saved, the new sample remains at the location specified by the [Temporary Folder](#).

8.2.11 Replacing and Editing the Sample

To replace the sample referenced by the clip with a different one, drop the new sample directly from the File Browser into the Clip View. Clip settings like pitch and volume will be retained. The Warp Markers will be retained only if the new sample has the exact same length as the old sample.

The Sample Display's  (PC) /   (Mac) context menu includes the Manage Sample File command. This opens the File Manager for the current Set with the sample referenced by the clip selected. From there, you can [replace and destructively edit the sample](#), in such a way that all clips and instruments referencing the sample will be affected. You can also use the Show in Browser command in the  (PC) /   (Mac) context menu to reveal the file in the Browser.

8.3 The Notes Box

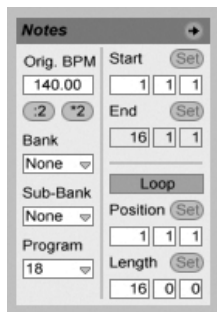

The Notes Box.

8.3.1 Tempo Controls

The Orig. BPM field displays Live's interpretation of the tempo at which the clip's MIDI was recorded. When dragging up or down in the Original BPM field, or clicking the :2 and *2 buttons, you will see that the notes in the MIDI Editor are correspondingly stretched or compressed. This is useful for aligning notes that you have recorded without a tempo reference, like Live's [metronome](#).

8.3.2 Bank and Program Change

Live can send MIDI bank/program change messages to external devices and plug-ins that support MIDI program change messages. According to the settings in these controls, launching a clip also sends its bank/program change message. If you are using Live to send MIDI to your synth, this means that each MIDI clip in your Live Set can play a different sound on your synth. Live offers messages for 128 banks with 128 sub-banks, each of which has 128 programs. Please see the documentation that came with your synthesizer to determine how many of these messages it can use. If you do not want your clip to send program or bank change messages, simply set the bank/program choosers to "None."

8.3.3 MIDI Loop/Region

These controls manage how the contents of a MIDI clip are played and shown in the MIDI Editor. They work the same way as those for [audio clips](#).

In the MIDI Editor, the zoom/scroll area is located above the beat-time ruler, the scrub area just below.

8.4 Clip Defaults and Update Rate

You can change the rate at which Live applies your Clip View settings to a running clip. Clip View changes will be quantized by the rate selected from the Clip Update Rate chooser in the Record/Warp/Launch Preferences. Certain clip settings, such as Launch Mode and Warp Mode, can be set up as defaults for all new clips. This is also done in the Record/Warp/Launch Preferences.

Chapter 9

Tempo Control and Warping

Unlike music stored on tape or in a traditional digital audio workstation, the music in Live remains “elastic” at all times. Live is capable of *time-warping* samples while streaming them from disk so as to synchronize them to the current Live Set’s tempo. This happens without affecting the pitch, which can be changed independently. Mixing and matching audio from different origins is therefore extremely easy.

9.1 Tempo

9.1.1 Setting the Tempo



The Control Bar's Tempo Field.

The Control Bar’s Tempo field allows you to change the playback tempo of your Live Set at any time, in real time. You can even *automate the tempo* to create smooth or sudden tempo changes along the song timeline. For maximum tempo control during performance, you can *MIDI map* separate controllers to the Tempo field on both sides of the decimal point. Setting one knob to control coarse tempo in BPM and another to control fine tempo

in hundredths of a BPM allows for enough precision to adjust to live performers or other unsynchronized sources.

You can have an external sequencer (or drum machine) play along with Live or have Live play along with the sequencer. The respective settings are made in the MIDI/Sync Preferences, and the EXT switch next to the tempo control is activated to have Live follow an external MIDI clock source. Please refer to the section on [synchronization](#) for details.

9.1.2 Tapping the Tempo



The Tap Button.

You can use Live's Tap Tempo function to set the tempo at any time. As you click the Control Bar's Tap Tempo button once every beat, the tempo of the Live Set will follow your tapping.

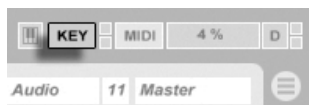

The Key Map Mode Switch.

It is better to assign the Tap button to a computer key than using the mouse. Click on the Control Bar's KEY switch to enter Key Map Mode; then select the Tap button; press the key you would like to use for tapping; click the KEY switch again to leave Key Map Mode. The assignment will take effect immediately. The Tap button can also be assigned to a MIDI note or controller, like a foot switch, in a [similar fashion](#). Although Live responds to your tapping immediately, it does apply some degree of inertia to prevent sluggish behavior in the software. The more taps Live receives in a row, the more precisely it will be able to conclude the desired tempo.

You can also use tapping to count in: If you are working in a 4:4 signature, it takes four taps to start song playback at the tapped tempo.

9.1.3 Nudging the Tempo



The Nudge Buttons.

Although Live can be easily [synchronized to external MIDI devices](#), you may find yourself in situations in which you need to adjust to sources that aren't locked to one tempo, such as live musicians or turntables. As long as your Set's tempo is basically the same as that of the unsynchronized material, you can use the Nudge buttons to temporarily speed up or slow down Live's playback to match what you hear. As with the Tap button, these buttons are much easier to use when [mapped to MIDI controllers](#).

9.2 Time-Warping Samples

Live's ability to play any sample in sync with a chosen tempo is a unique and important feature. In addition, you can "warp" the rhythmic flow of a piece, changing its "feel," or even move notes to other meter positions.

A clip's warping properties are set in the [Sample box](#), which is a sub-section of the Clip View.

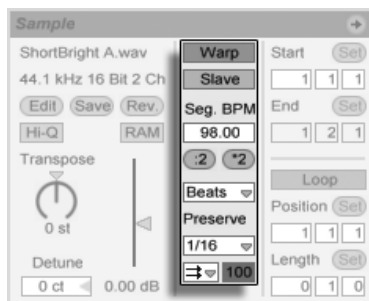

The Sample Box's Warping Controls.

The most significant control here is the *Warp* switch, which toggles a clip's warping on or off. The Warp section of Live's Preferences will determine the default warp settings for new clips, but they can always be overridden here on a per-clip basis.

When the Warp switch is off, Live plays the sample at its original, "normal" tempo, irrespective of the current Live Set's tempo. This is useful for samples that have no inherent rhythmic structure: percussion hits, atmospheres, sound effects, spoken word and the like. Turn the Warp switch on to play rhythmically structured samples (such as sample loops, music recordings, complete music pieces, etc.) in sync with the current song tempo.

To direct Live's assumptions about new samples, use the Record/Warp/Launch tab of Live's



Preferences. If the Auto-Warp Long Samples preference is on, Live assumes that long samples contain music that should be played in sync with the Live Set's tempo. If you would rather have Live default to playing long samples as they are, disengage this preference.

9.2.1 Tempo Master/Slave

All warped clips in the Arrangement View have one further option: They can be defined as *tempo masters* by toggling their Master/Slave switches. Any number of clips can be set as tempo masters, but only one clip at a time can actually be the tempo master. This distinction is always granted to the bottom-most, currently playing clip in the Arrangement View.

The clip that is the current tempo master will play as if warping was *off*, but with one important difference – the rest of the Live Set will be warped so that it plays in sync with the current tempo master.



This is achieved by adding tempo automation to the Master track for the duration of the tempo master clip. You will notice that the Tempo field in Live's Control Bar becomes disabled in this state; this is because all tempo control is handed over to the tempo master clip.

When toggling a clip's Master/Slave switch, or when deleting a clip that was set as tempo master, the Master track tempo automation is removed again, restoring the proper tempo to the region. If you wish instead to *keep* the generated tempo automation to continue working with it, then  (PC) /  (Mac) on the Control Bar's Tempo field, and choose the Unslave Tempo Automation command. All clips will then be set to Slave, but the tempo automation will remain in place.

Note that when Live's **EXT switch is enabled**, the Master/Slave switch has no effect and appears disabled.

9.2.2 Warp Markers

Think of a sample as a rubber-band that you want to pin to a (musical time) ruler. In Live, the pins are called *Warp Markers*. A Warp Marker locks a specific point in the sample to a specific place in the measure. You can use any number of Warp Markers to create an arbitrary mapping of the piece's inherent rhythm to a musical meter.

Warp Markers are set in the Clip View's Sample Display by double-clicking within the sample. They can then be dragged or moved with the arrow keys to different points in time. Warp Markers can also be deleted by double-clicking them, or by pressing the computer keyboard's  or  key after selecting them.

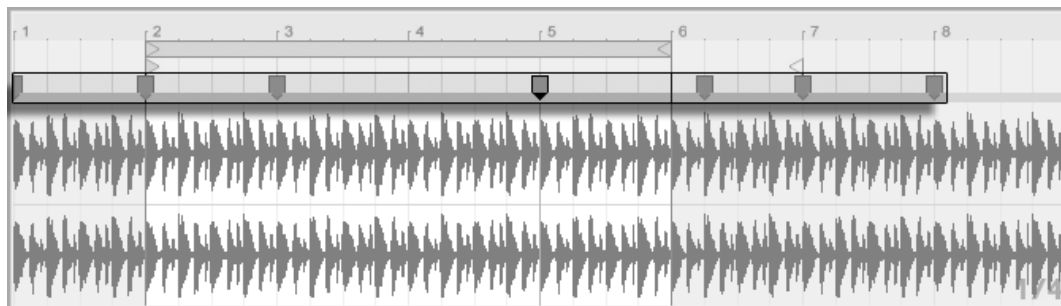

Double-Clicking In the Sample Creates a Warp Marker.

When working with your sample, you can have Live scroll the Sample Display to follow playback. Use the Control Bar's Follow switch to activate this feature. It also might be helpful to vertically resize the Sample Display by dragging on the split line between the Clip View and the Session View track area.



The Follow Switch in the Control Bar.

Transients and Pseudo Warp Markers

When you first load a sample into Live, Live automatically analyzes the audio and finds its *transients*. These are the points in the audio where notes or events begin, and are usually good places to put Warp Markers. Transients appear as small markers at the top of the sample display after zooming in.

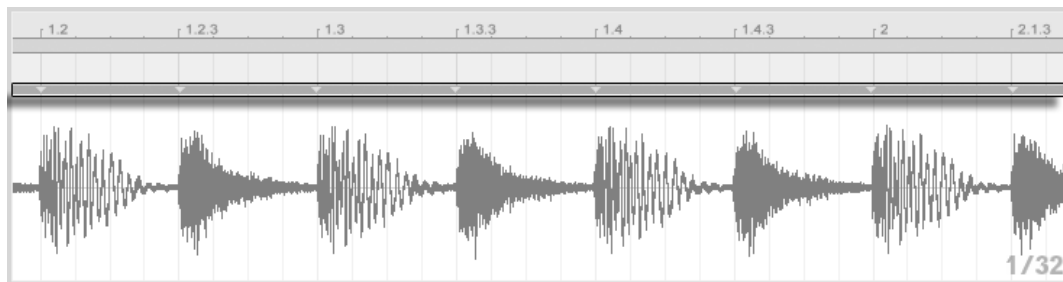

Transient Markers.

As you mouse over transients, temporary “pseudo” Warp Markers appear. These have the same shape as regular Warp Markers, but they’re grey. Double-clicking or dragging a pseudo Warp Marker creates an actual Warp Marker or, if there are no Warp Markers later in the clip, changes the tempo for the clip segment. Holding the **Ctrl** (PC) / **⌘** (Mac) modifier while creating a Warp Marker on a transient also creates Warp Markers at the adjacent transients. Holding the **⇧** modifier while clicking on a pseudo Warp Marker allows you to drag the transient to a new position.

You can also select a range of time and create Warp Markers at all of the transients within the range via the Create menu’s “Insert Warp Markers” command. If there are no transients within your time selection, a Warp Marker will be created at the end of the selection.

Although Live usually does a good job of placing transients in the right places, you can delete and create transients as well, via the corresponding commands in the Create menu.

Saving Warp Markers

Your Warp Markers will automatically be saved with the Live Set, but you may also want to save them with the sample file itself, so that they are reconstructed anytime you drag the file into Live. To do this, click the Clip View’s [Save button](#).

Note that if a sample has a [saved set of Warp Markers](#), Auto-Warp will have no effect. When this is the case, you can use any of the **⌘** (PC) / **⌘** (Mac) context menu commands described in this section to initiate auto-warping.

9.2.3 Using Warp Markers

In the following sections, we will look at a couple of applications for time-warping samples. Warping is, of course, an optional property of clips.

Syncing Straight Loops

When you import a sample that represents a well-cut musical loop of 1,2,4 or 8 bars in length, Live usually makes the correct assumptions to play the loop in sync with the chosen tempo. It creates two Warp Markers, one at the sample's beginning and one at the end.

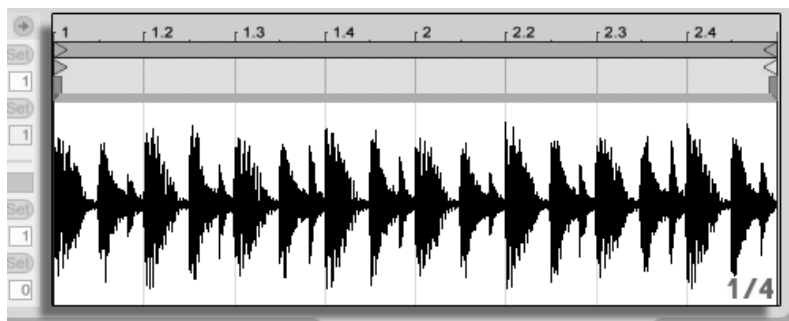

A Two-Bar Loop as It Appears in the Clip View, by Default.

The Seg. BPM field displays Live's guess of the loop's tempo; if you happen to know the tempo of the loop, you can type it in here. Sometimes Live's guess of the original tempo is wrong by half or double. If so, correct this by clicking on the buttons labeled *2 and :2, respectively. The sample plays at double speed when you press :2 because you are changing Live's interpretation of the sample's tempo, which serves as a point of reference for determining the required time-stretch factor.

Syncing Uncut Loops

When importing a loop that has not been edited into a well-cut loop, Live will play it out of sync. Suppose there is a portion of silence at the sample beginning, prior to the first beat. You can easily correct this by placing a Warp Marker at the beginning of the audio and dragging it so that it lines up with the beginning of bar one in the timeline. Likewise,

you can eliminate silence after the actual loop end by placing a Warp Marker at the sample's right edge.

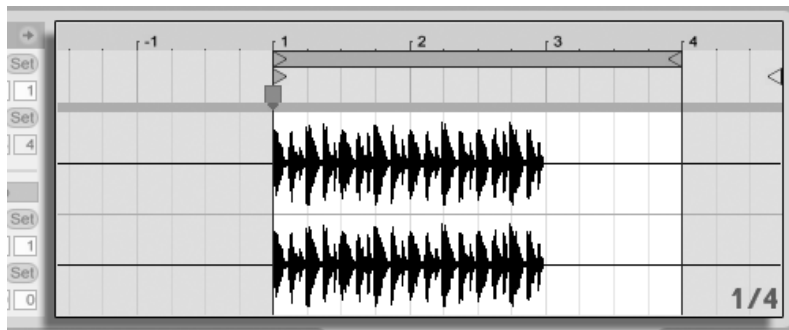

Setting the Warp Markers for a Poorly Cut Loop.

Syncing Odd-Length Loops

If you import a sample that contains a seven-bar loop, Live initially assumes the loop is eight bars long (or four, depending on its length) and plays it out of sync. For correct playback, the marker at the end of the sample needs to be at the beginning of bar eight, not bar nine. To fix this, simply drag the ending marker to the correct position.

If Live's initial guess had been a four-bar loop, the eighth bar may not initially be visible. In that case, you can drag the Warp Marker at the end toward the right until the eight becomes visible.

Manipulating Grooves

You can now create any number of Warp Markers by double-clicking within the sample or on transient locations. Drag in a "straight" looped sample, set a few Warp Markers, and move them around to see what happens. Warp Markers really serve two purposes:

1. to provide a "correct" interpretation of the flow of musical time in the sample;
2. to mess up the flow of time in the sample.

If a single event in a percussion loop comes late, just pin a Warp Marker to it and drag the marker to the correct beat position. You may want to pin the adjacent events as well, to avoid affecting neighboring regions in the sample.

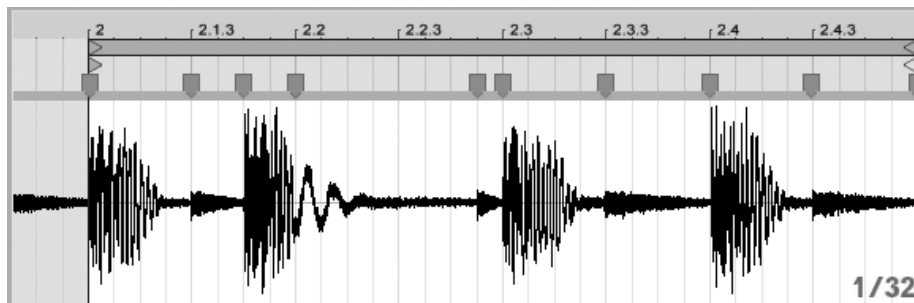



Using Warp Markers to Manipulate the Groove.

“Removing” a sample’s natural groove by applying Warp Markers is an interesting creative method, particularly in conjunction with Live’s [ability to impose an artificial groove onto clips in real-time](#).

Syncing Longer Pieces

Live’s *Auto-Warp* algorithm makes longer samples and entire songs readily available for integration into your project. You can use the [Browser](#) to import long samples or MP3, AAC, Ogg Vorbis, Ogg FLAC and FLAC files.

When you drag a file into Live that is too long to justify the assumption that it is a loop or a one-shot, Live will auto-warp the clip by default (though this can be changed in the [Record/Warp/Launch Preferences](#)).

Note that, for the auto-warp mechanism to work, files which are being imported into the program for the first time will need to undergo a first-time [analysis process](#) and will not be immediately available for playing or editing. As explained in the section in this manual on analysis files, analysis can be batch-processed with the  (PC) /  (Mac) context menu’s Analyze Audio command. Once analysis is finished, you can view the results of Auto-Warp’s assumptions about the file.

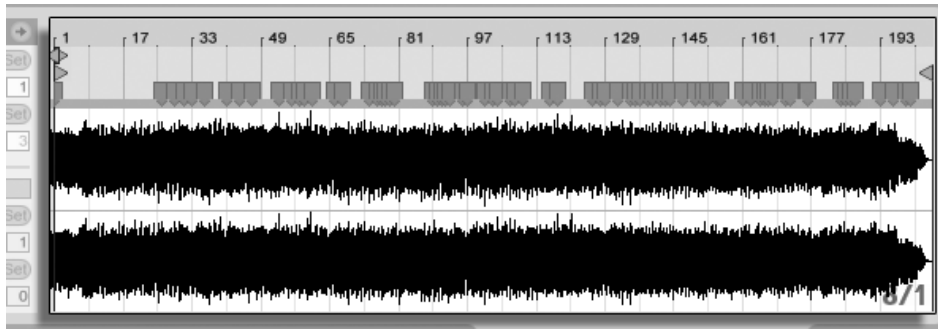



Auto-Warp's Results in the Clip View.

As long as Auto-Warp made the correct set of informed guesses, the clip will be ready to play in perfect sync with the Live Set's tempo. However, if Auto-Warp does not quite do what you want, you can control its results. The remainder of this section will focus on various ways of guiding Live's auto-warping. Remember that the metronome in the Control Bar will probably come in handy as you warp longer pieces.



The Metronome Switch.

It might happen that Auto-Warp guesses the tempo correctly but gets the downbeat wrong. To remedy this, you can do the following:

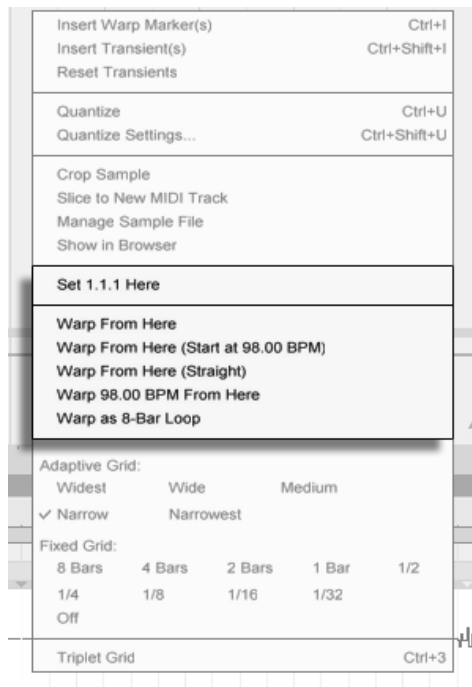

- Zoom in and create a Warp Marker on the downbeat. Then drag it to the beginning of bar 1 in the timeline;
- Use the start marker's  (PC) /  (Mac) context menu to select the *Set 1.1.1 Here* command.



Using the Context Menu to Direct Auto-Warp.

Directing Auto-Warp is also relatively simple when you have imported a perfectly cut loop. You can tell Auto-Warp to work accordingly using the *Warp As ...-Bar Loop* command. Live will propose a loop length that makes the most sense given the current Live Set's tempo. Decreasing the Live Set's tempo can, for instance, lead Live to assume the loop is 8 bars at 90 BPM instead of 16 bars at 180 BPM.

Sometimes more accurate control of Auto-Warp is necessary. The best way to go about warping a clip that requires more detailed attention is in sections, working gradually from left to right. You can set a Warp Marker by double-clicking in the sample to the right of each correctly warped section, "pinning" it into place. The shortcuts for working with the [clip loop brace and start/end markers](#) can speed up this process considerably.

You might also find it helpful to select multiple Warp Markers for moving by selecting them with the  or  (PC) /  (Mac) modifiers held down.

The four Warp From Here commands provide various ways of resetting Warp Markers to the right of the selected grid marker or Warp Marker, leaving Warp Markers to the left untouched. These commands are also available from the start marker.

- *Warp From Here* runs the Auto-Warp algorithm on the material to the right of the selected marker.
- *Warp From Here (Start At ...)* directs Auto-Warp to use the current Live Set's tempo as a starting point for tempo tracking. The strategy here is as follows:
 1. Deactivate the Warp switch for the clip so that it plays unwarped;
 2. Use the Control Bar's Tap Tempo button to tap along, thereby setting the Live Set's tempo to match that of the clip;
 3. Turn warping on again and use the Warp From Here (Start At ...) command to tell Auto-Warp to use your tapped tempo as a reference.
- *Warp From Here (Straight)* tells Auto-Warp that this is a clip with no tempo variations (common in electronically produced works). Auto-Warp will then set a single Warp Marker derived from its guess of the file's original tempo.
- *Warp ... BPM From Here* will also set a single Warp Marker, but in this case, Auto-Warp is forced to interpret the clip as exactly matching the Live Set's tempo. This is useful in cases when you happen to know the exact BPM value of an electronically-produced work and can type it into the Control Bar before warping.

Multi-Clip Warping

When clips of equal length are multi-selected, adding or changing Warp Markers for one clip will apply identical Warp Markers to all. This is convenient in any situation where several tracks have the same rhythm, and you wish to alter the timing of each recording in the same way. A common scenario would be when multi-tracking a band's performance, where the musicians all play in time with each other, yet the timing itself is in some way flawed.

9.2.4 Quantizing Audio

In the previous section, you learned how to adjust the timing of events in audio files by manually dragging Warp Markers along the timeline. But it is also possible to automatically snap the entire sample to the grid at once by using the Quantize command. To do this, click in the background of the sample editor and choose the Quantize command from the Edit menu, or use the **Ctrl** **U** (PC) / **⌘** **U** (Mac) hotkey. This will quantize using default settings, or the settings that you previously applied.

To adjust your quantization parameters, open the Quantization Settings dialog from the Edit menu.

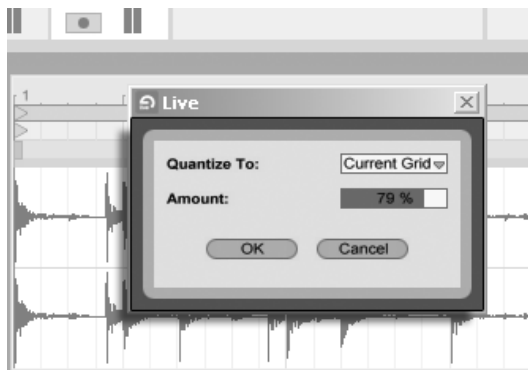

Quantizing Audio Samples.

Using the options presented here, you can select either the current grid size or a specific meter value for quantization. You can also quantize without that “quantized” feel by adjusting the Amount control, which will move Warp Markers by a percentage of the set quantization value.

9.3 Adjusting for Good Stretching Quality

Live offers a number of time-stretching modes to accommodate all sorts of audio material. Each clip’s time-stretching mode and associated parameters are set in the Clip View’s *Sample Box*.

The warp modes are different varieties of granular resynthesis techniques. Granular resynthesis achieves time compression and expansion by repeating and skipping over parts of the sample (the “grains”). The warp modes differ in the selection of grains, as well as in the details of overlapping and crossfading between grains.

Let’s investigate which warp modes work best for different types of signals and how to adjust the warping controls for “clean” stretching. It’s also fun to “misuse” these controls to achieve interesting artifacts instead of accurate stretching.

9.3.1 Beats Mode

Beats Mode works best for material where rhythm is dominant (e.g., drum loops as well as most pieces of electronic dance music). The granulation process is optimized to preserve transients in the audio material.

Use the *Preserve* control to preserve divisions in the sample as boundaries when warping. For the most accurate results, particularly with percussive material, choose *Transients*. This setting uses the positions of the analyzed (or user-created) transients to determine warping behavior. To preserve specific beat divisions regardless of the sample’s contents, choose one of the fixed note values. For some interesting rhythmic artifacts, choose large note values in conjunction with pitch transposition.

The Transient Loop Mode chooser sets the looping properties for the clip’s transients:

 *Loop Off* – Each segment of audio between transients plays to its end and then stops. Any remaining time between the end of a segment and the next transient will be silent.

 *Loop Forward* – Each segment of audio between transients plays to its end. Playback then jumps back to a zero-crossing near the middle of the segment and continues looping until the time when the next transient occurs.

 *Loop Back-and-Forth* – Each segment of audio between transients plays to its end. Playback then reverses until it reaches a zero-crossing near the middle of the segment, and then proceeds again towards the end of the segment. This pattern continues until the time when the next transient occurs. This mode, in conjunction with the *Preserve Transients* selection, can often result in very good quality at slower tempos.

The Transient Envelope slider applies a volume fade to each segment of audio. At 100, there is no fade. At 0, each segment decays very quickly. Long envelope times can help to smooth clicks at the end of segments, while short times can be used to apply rhythmic gating effects.

9.3.2 Tones Mode

Tones Mode serves well for stretching material with a more or less clear pitch structure, such as vocals, monophonic instruments and basslines.

Grain Size provides rough control over the average grain size used. The actual grain size is determined in a signal-dependent manner. For signals with a clear sense of pitch contour, a small grain size works best. Larger grain sizes help avoid artifacts that can occur when the pitch contour is unclear, but the tradeoff can be audible repetitions.

9.3.3 Texture Mode

Texture Mode works well for sound textures with an ambiguous pitch contour (e.g., polyphonic orchestral music, noise, atmospheric pads, etc.). It also offers rich potential for manipulating all kinds of sounds in a creative way.

The *Grain Size* control determines the grain size used, but unlike in Tones Mode, this is a setting that Live will use unaltered, without considering the signal's characteristics.

Fluctuation introduces randomness into the process. Larger values give more randomness.

9.3.4 Re-Pitch Mode

In Re-Pitch Mode, Live doesn't really time-stretch or compress the music; instead, it adjusts the playback rate to create the desired amount of stretching. In other words, to speed up playback by a factor of 2, it's transposed up an octave. This is like the "DJ stretching method" of using variable-speed turntables to sync two records, or what happens to samples in samplers when they're transposed.

The Transpose and Detune controls have no effect in Re-Pitch Mode.

9.3.5 Complex Mode

Complex Mode is a warping method specifically designed to accommodate composite signals that combine the characteristics covered by other Warp Modes; it works well for warping entire songs, which usually contain beats, tones and textures.

Complex Mode is a rather CPU-intensive function, using approximately ten times the CPU resources required by the other Warp Modes. As such, you may want to **freeze tracks** where Complex Mode is used or **record** the results as a new clip to use as a substitute.

9.3.6 Complex Pro Mode



Complex Pro Mode uses a variation of the algorithm found in Complex mode, and may offer even better results (although with an increase in CPU usage.) Like Complex Mode, Complex Pro works especially well with polyphonic textures or whole songs.

The *Formants* slider adjusts the extent to which the formants of the sample are compensated when transposing. At 100%, the original formants will be preserved, which allows for large changes in transposition while maintaining the sample's original tonal quality. Note that this slider has no effect if the sample is played back untransposed.

The *Envelope* slider also influences the spectral characteristics of the material. The default setting of 128 should work well for most audio. For very high-pitched samples, you may have better results with lower Envelope values. Likewise, low-pitched material may sound better with higher values.

9.3.7 REX Mode

REX Mode differs from the other Warp modes in several ways. Most notably, it is not available as an option in the Clip View's Sample Box, but is instead enabled automatically when loading a file in REX format. REX files, associated with the program *ReCycle* by *Propellerhead Software*, contain embedded tempo and timing information and will synchronize to your Set's tempo just like any other audio file.

Although REX files are audio files, they can quickly be transformed into playable instruments via the *Slice to New MIDI Track* command, which is available in the Create Menu or the  (PC) /  (Mac) context menu for the Clip.

Warp Markers/parameters, *Clip Envelopes* that affect warping properties, and the *Clip Nudge* controls are not available for REX files.

Chapter 10

Editing MIDI Notes and Velocities

A MIDI clip in Live contains notes and controller data for playing a MIDI instrument. This instrument can be a virtual instrument in a MIDI track's **device chain** or an external synth fed via the track's **output routing**. The **MIDI clip** provides the device with a musical score to play, specifying note pitch, length, position and dynamics (referred to as *velocity* in the MIDI lexicon). MIDI is composed and edited in Live's MIDI Editor.

10.1 Creating an Empty MIDI Clip

MIDI clips are created

- by means of **recording**;
- or by double-clicking an empty Session slot in a MIDI track;
- or by selecting an empty Session slot in a MIDI track and choosing the Create menu's Insert MIDI Clip command;
- or, in the Arrangement View, by selecting a timespan in a MIDI track and choosing the Create menu's Insert MIDI Clip command.

10.2 The MIDI Editor

To bring up the MIDI Editor, double-click a MIDI clip to open the Clip View. You can use the Clip View Box selector to make sure the **Notes box** is showing, then click in the title bar of the Notes box to bring up the MIDI Editor on the right-hand side of the screen.

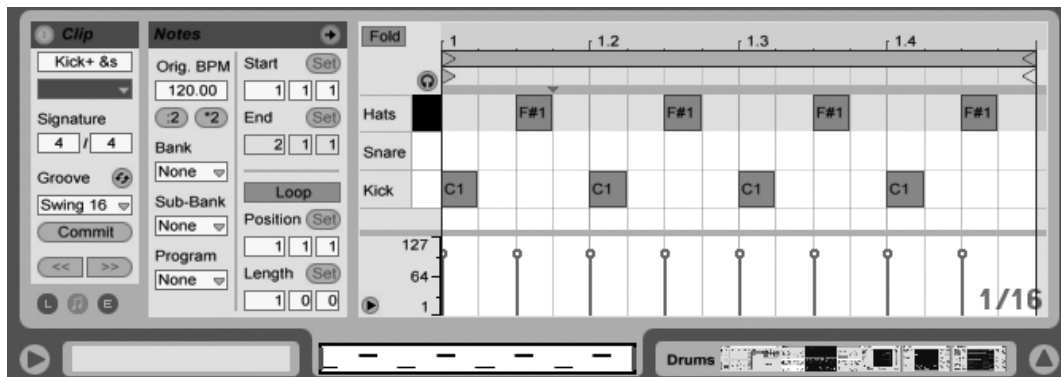

The MIDI Editor.

The MIDI Editor is divided into two editing windows: the upper Note Editor and the lower Velocity Editor. You can resize the Velocity Editor by dragging on the split line that runs between it and the Note Editor. You can also show and hide the Velocity Editor using the triangular button on the left-hand side of the split line.



The Control Bar's Draw Mode Switch.

Switch to Draw Mode by activating the Control Bar's Draw Mode switch. You can now draw MIDI notes into the Note Editor with the mouse. Deactivating Draw Mode allows notes to be selected and moved around via clipboard operations or by clicking and dragging, either vertically to change their transposition, or horizontally to change their position in time. MIDI notes can also be added and deleted by double-clicking when Draw Mode is inactive.

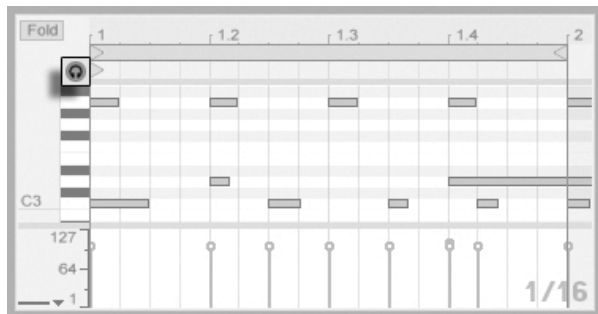

Previewing MIDI Notes.

Provided your MIDI track's device chain contains an **instrument**, activating the Preview switch in the MIDI Editor allows you to hear notes as you select and move them. If the MIDI track is armed, activating Preview also allows you to **step record** new notes into the clip.

Note velocity is adjusted in the Velocity Editor, by clicking and dragging on the associated markers. You can also use Draw Mode in the Velocity Editor: It will draw identical velocities for all notes within a grid "tile."

After drawing a few notes and moving them around, you will probably want to know how to get around in the Note Editor. So, before we get into detailed editing information, we will first explain MIDI Editor navigation.

10.3 MIDI Editor Navigation and Transport

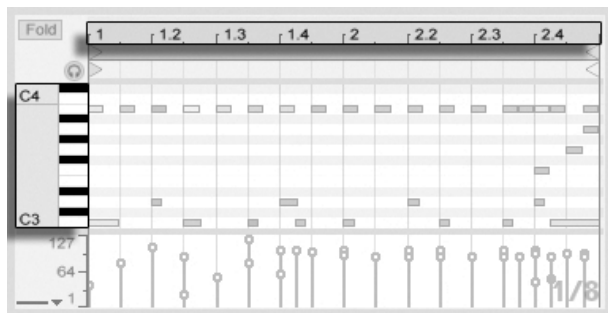

Note Scale Position Is Shown Vertically and Beat-Time Horizontally.

The MIDI Editor has both vertical and horizontal navigation. Along the horizontal axis lies a time ruler, which shows note position along a musical timeline. The vertical axis contains the note ruler, displaying octaves C0–C10, and a representation of a piano keyboard (the piano roll). Note that if the Preview switch at the top of the piano roll is activated, you can listen to the results of your piano roll playing.

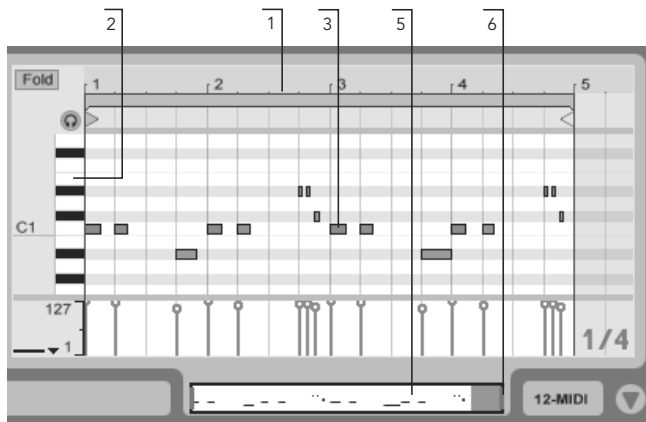

MIDI Editor Navigation.

1. To smoothly change the time-zoom level, click and drag vertically in the time ruler. Drag horizontally in the time ruler to scroll from left to right.
2. Click and drag vertically in the note ruler to change which octaves are shown, or drag horizontally to change the vertical zoom size of MIDI notes and the keyboard.
3. Click and drag over one or more notes to select them, or over a portion of the editor's background to select a range of time. Then, double-click on the note or time ruler to automatically zoom in on your selection. If nothing is selected, double-clicking the note ruler will zoom in on the area from the lowest to the highest note in the clip, while double-clicking the time ruler will zoom out to show the time between the first and last note.
4. To zoom in and out around the current selection, use the computer keyboard's + and - keys.
5. The Clip Overview just beneath the MIDI Editor can also be used for navigation.

It always shows the complete contents of the selected MIDI clip. The black rectangular outline represents the part of the clip that is currently displayed in the Editor above. To scroll, click within the outline and drag left or right; to zoom in and out, drag up and down.

6. Change the length of what is shown in the Editor by dragging the left or right edges of the outline in the Clip Overview.
7. To quickly change what is shown in the Editor, click on a section that you want to examine in the Clip Overview, then drag downwards to zoom in, or scroll by dragging left and right.



The Control Bar's Follow Switch.

The area displayed in the Note Editor can be set to scroll with playback using the Follow switch from the Control Bar.

When Permanent Scrub Areas is enabled in Live's Look/Feel Preferences, clicking in the scrub area below the beat-time ruler starts playback from that point, rounded by the global quantization setting. When the Permanent Scrub Areas preference is off, you can still scrub by -clicking anywhere in the scrub area or in the beat-time ruler. Learning about the [loop/region controls](#) and associated shortcuts can also be helpful in getting around in the MIDI Editor and playing selections quickly and easily.

As you work with MIDI, you may find yourself needing extra screen space. You can click and drag vertically on the window split between the Session or Arrangement View and the Clip View to enlarge the MIDI Editor.

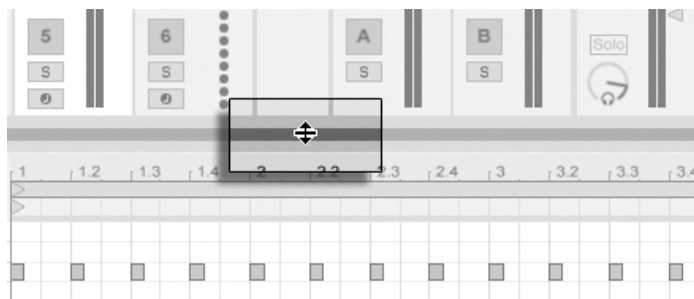

Enlarge the MIDI Editor by Dragging the Window Split Between Session and Clip Views.

10.4 Editing MIDI

10.4.1 Non-Destructive Editing

You can always return your MIDI clip to its previous state by using the Edit menu's Undo command. Furthermore, if the MIDI clip being edited originated in a MIDI file on your hard drive, none of your editing will alter the original MIDI file, as Live incorporates its contents into your Live Set when importing.

10.4.2 Folding and Looping

An important feature of the MIDI Editor is the Fold button, located in the upper left corner. Activating this button will immediately hide all rows, or *key tracks*, that do not contain MIDI notes in any clips in the track. This is very useful when working with percussion kits, for example, which are oftentimes mapped out along a keyboard in sections corresponding to percussion type (e.g., snares grouped together two octaves down from hi-hat cymbals, etc.). When working with a MIDI file created by such a mapping, sometimes only one or two of each type of percussion sound is used, and it becomes unnecessary to view the entire keyboard range.



The Fold Button Extracts Key Tracks Containing Notes.

When editing MIDI, you might find that you want to change which part of the clip you are listening to, or loop the clip in order to listen to it repeatedly. You can use the [loop/region markers](#) for this.

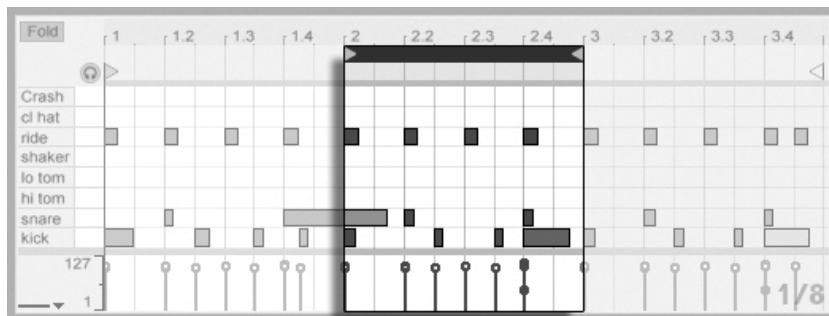

Use the Loop/Region Markers to Select a Specific Region of the Clip to Play.

10.4.3 Grid Snapping

Most functions in the MIDI Editor are subject to **grid snapping**. You can hold down the **Alt** (PC) / **⌘** (Mac) modifier while performing an action to bypass grid snapping.

Note movements will also snap to an “offset,” which is based on the original placement of the note relative to the grid. This is useful for preserving a groove or loose playing style that you do not necessarily want to “set straight.”

10.4.4 Editing Notes

Editing in the MIDI Editor is similar to **editing in the Arrangement**. In both cases, your actions are selection-based: you select something using the mouse, then execute a menu command (e.g., Cut, Copy, Paste, Duplicate) on the selection.

Here is how selection works:

- Clicking a note selects the note. Multiple notes can be selected in unison: “rubber-band” select more than one note with one mouse motion by clicking in empty space, then dragging to enclose the notes in the dotted line that appears. **Esc** deselects all selected notes.;
- Clicking into the background of the MIDI Editor selects a point in time, represented by a flashing insert mark.

- Clicking and dragging in the background selects a timespan. To select all of the notes that begin during the timespan, press **Return**.

After placing the insert mark, you can manipulate it using your computer keyboard.

- Press **←** or **→** to move the insert mark to the left or right, according to the grid settings. **Ctrl** (PC) / **Alt** (Mac) **←** or **→** moves the insert mark to the next note boundary.
- Hold down **⇧** while pressing the arrow keys to extend or retract the selected timespan by moving the insert mark. **Alt** (PC) / **Alt** (Mac) + **⇧** while pressing the arrow keys extends or retracts from the opposite side of the selection.
- The insert mark can be moved to the beginning or end of a MIDI clip by pressing the Home or End key, respectively.

As we have seen, notes in the MIDI Editor can be moved both horizontally (changing their position in time) and vertically (changing their transposition). They can be moved either by clicking and dragging, or with the arrow keys on your computer keyboard; in either case, they are subject to grid and offset snapping. If you are playing the clip while you edit notes, you can listen to them play in their new assignments as you change them.

Several key modifiers also apply to note editing:

- To transpose selected notes by octave, hold down **⇧** while pressing **↑** or **↓**.
- **⇧** **←** or **→** extends or retracts the duration of selected notes, according to the grid settings.
- To change the selection to the next note in the same key track, hold the **Alt** (PC) / **⌘** (Mac) while pressing **←** or **→**. **Alt** (PC) / **⌘** (Mac) **↑** or **↓** moves the selection to the next note in time.
- You can use the **⇧** modifier to click and add individual notes or additional “rubber-band” selections to your current selection. You can also remove a single note from your selection by holding down **⇧** and clicking on it. Holding **⇧** and clicking on the piano roll adds all notes in a single key track to the current selection, or removes them if they were already selected.

Selecting a note (or notes) makes it subject to commands from the Edit menu, such as Copy and Paste. Notes in the clipboard will be pasted starting at the location of the insert mark.

You can also use the **Ctrl** (PC) / **Alt** (Mac) modifier to click and drag copies of notes to a new location. If you click and drag to move notes but then decide that you would like to copy them instead, you can press the **Ctrl** (PC) / **Alt** (Mac) modifier even after starting the drag.

When editing or drawing, you may sometimes place a new note on top of one that already exists. If the new note overlaps with the beginning of the original note, the original note will vanish. If the new note overlaps with the “tail” of the original, the original note’s length will change so that it lasts just until the new note’s beginning.

10.4.5 Changing Note Length

Clicking and dragging on a note’s left or right edges changes its length. Note length can only be changed when Draw Mode is inactive, and will be quantized unless the **Alt** (PC) / **⌘** (Mac) modifier is held down while dragging.

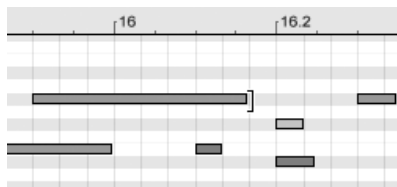

Changing Note Length.

Tip: To set a group of notes to the same length, select them all, grab the end of the longest one, drag them all down to zero length and then extend them.

10.4.6 The ...Time Commands in the MIDI Editor

The standard clipboard commands like Cut, Copy and Paste only affect the currently selected notes (or the notes within a time selection). But, **as in Arrangement editing**, there are “...Time” commands that act upon the entire MIDI clip by inserting and deleting time.

Note that these operations do *not* change the clip start/end position or the loop brace settings.

- *Cut Time* cuts a selection of time from the MIDI clip, thereby moving any notes on either side of the cut area closer together in the timeline.

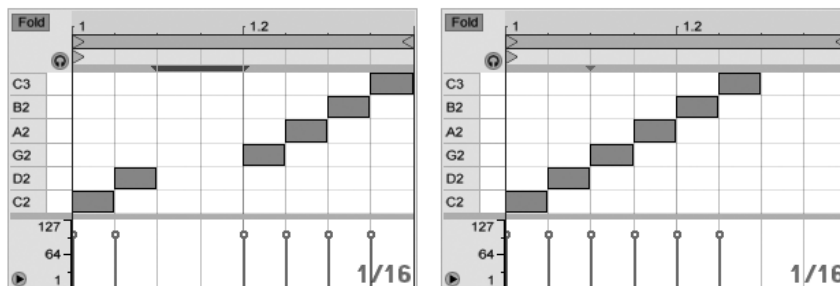

A Gap Between MIDI Notes Has Been Cut by First Selecting It, Then Executing the Cut Time Command.

- *Paste Time* places copied time into the MIDI clip, along with any notes that were in the copied time.
- *Duplicate Time* places a copy of the selected timespan into the clip, along with any contained notes.
- *Delete Time* deletes a selection of time from the MIDI clip, thereby moving any notes on either side of the deleted area closer together in the timeline.
- *Insert Silence* inserts as much empty time as is currently selected into the clip, before the selection.

10.4.7 Quantizing Notes

There are three options for quantizing MIDI notes in Live. First, you can **quantize MIDI notes as you record them**. Secondly, as **previously mentioned**, you can move notes so that they snap to the visible grid lines. Finally, you can select a note or notes and choose the Quantize command from the Edit menu, or use the **Ctrl U** (PC) / **⌘ U** (Mac) hotkey. The first time you do this, you will see a dialog box with several quantization options. This will quantize using default settings, or the settings that you previously applied.

To adjust your quantization parameters, open the Quantization Settings dialog from the Edit menu.

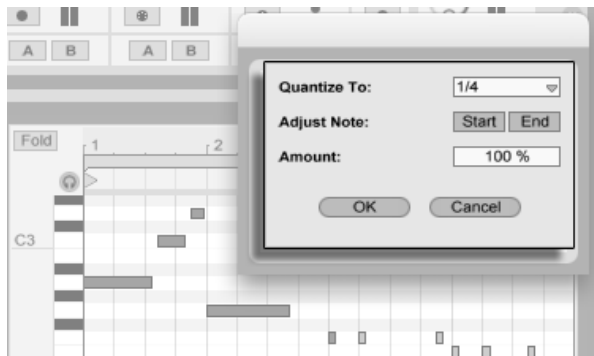

Quantizing MIDI Notes.

Using the options presented here, you can select either the current grid size or a specific meter value for quantization and set either the note start or end (or both) to be quantized. Quantizing the note end will stretch the note so that it ends at the chosen meter subdivision. You can also quantize notes without giving them that “quantized” feel using the Amount control, which will move notes only by a percentage of the set quantization value.

10.4.8 Editing Velocities



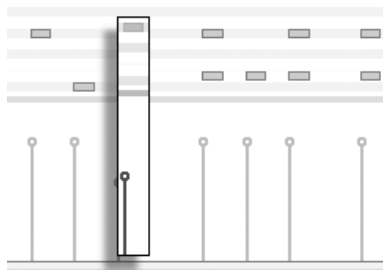





To change velocity for a MIDI note, click and drag on the associated marker in the Velocity Editor. (To help you locate the velocity marker belonging to a MIDI note that may be stacked vertically with others, Live highlights the velocity marker for whichever note your mouse is hovering over.) Velocity changes will be shown numerically in a small display in the time ruler.



Changing Note Velocity.



As in the Note Editor, you can select multiple velocity markers to change by clicking with the  modifier held down.



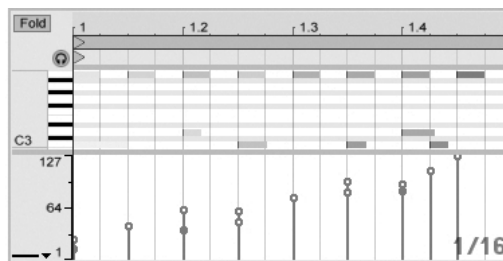
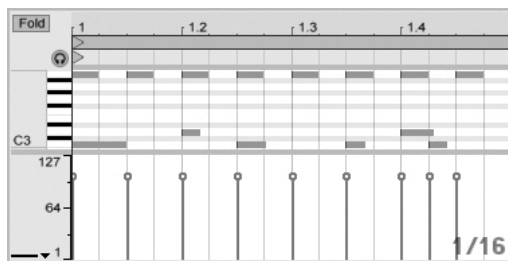

Tip: To set a group of notes so that they all have the same velocity, select their markers in the Velocity Editor, drag them up or down to either maximum or minimum velocity, and then adjust velocity to the desired value.



As we saw earlier, Draw Mode allows drawing identical velocities for all notes within a grid tile. While in Draw Mode, velocity drawing is limited to only those notes that are currently selected. To draw markers individually (as you would want to with a crescendo, for instance) deactivate grid snapping with the   (PC) /    (Mac) shortcut, or simply hold down the  (PC) /   (Mac) modifier.



Drawing Identical Velocities (Left) and a Crescendo (Right).

Tip: To draw a velocity ramp with notes that are all in the same key track, press  and click on the piano roll to select all notes within the desired key track, make sure Draw Mode is activated and draw the ramp into the Velocity Editor while holding the  modifier, so that you affect only the selected notes.



Tip #2: To draw a *linear* velocity ramp across a selection of notes, first select the notes that should be affected (using the  modifier to select non-adjacent notes if necessary). Make sure Draw Mode is *not* activated and draw the line into the Velocity Editor while holding the  (PC) /   (Mac) modifier.

Notes in the Note Editor display their velocity in their coloring – light notes play softly, and vice versa. To change the velocity of notes without the Velocity Editor open, click any selected note and drag vertically while pressing the  (PC) /   (Mac) modifier.

Vertical movements in Draw Mode correspond to velocity changes. This means that, with one horizontal motion and one vertical motion, you can draw multiple notes and their velocities without releasing the mouse button. If you change velocity with this vertical

movement, Live will remember the change and use your new velocity on any notes that you draw afterward.

Note-Off Velocity

By default, the Velocity Editor allows you to adjust note-on velocities. But you can toggle the editor to show *note-off* velocities via options in the editor's  (PC) /  (Mac) context menu.

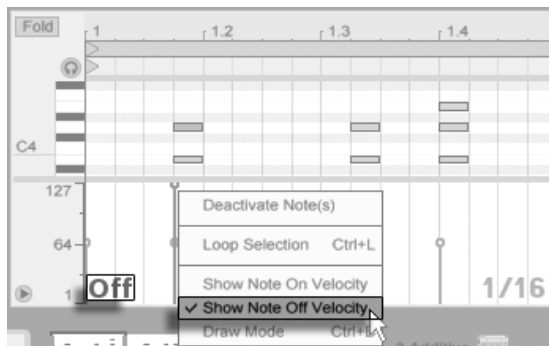



The Velocity Editor Showing Note-Off Velocities.

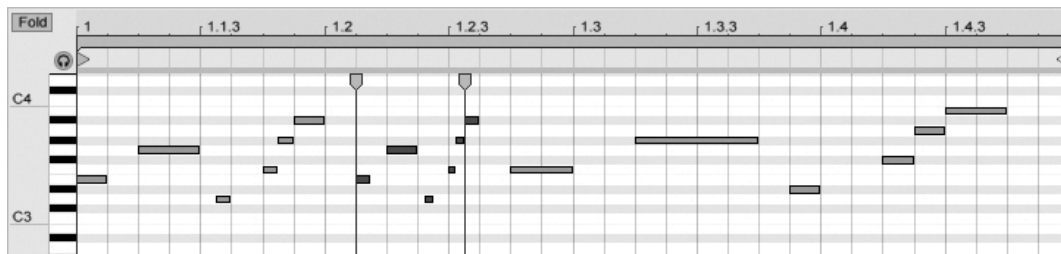

Please note that note-off (or “release”) velocity is a somewhat esoteric parameter, and is only supported by certain devices. Ableton’s [Sampler](#) instrument, for example, provides note-off velocity as a controller for a variety of parameters.

10.4.9 MIDI Note Stretch



Three Variations Created with the Stretch Notes Command.



When multiple notes are selected in the Note Editor, the Stretch Notes command becomes available from the context menu, if you invoke it with  (PC) /   (Mac). *Note Stretch markers* will then appear in the Note Editor, allowing notes to be scaled proportionally in time. The markers are a pair of downward-pointing indicators that snap to the beginning of the first and last notes in the selection.

By clicking and dragging one of the markers horizontally, the selected notes will move and stretch so that they continue to occupy the same proportion of time that they did when they were initially selected. The Note Stretch markers will always snap to the Note Editor's grid lines unless the grid is not shown, or the  (PC) /   (Mac) modifier is held while dragging.







If one marker is dragged beyond the boundary of the other, then the order of the stretched notes will be “reflected” in relation to their initial sequence; this is sometimes referred to as “retrograde” behavior.

Any changes occurring to the notes included in the Note Stretch before the mouse button is released will cancel the stretch operation. This can occur, for example, if the MIDI clip is simultaneously being overdubbed with new notes.

10.4.10 Cropping MIDI Clips

Unused MIDI data can be deleted by means of the Crop Clip command. Simply  (PC) /   (Mac) on a MIDI clip in the Session or Arrangement View and select this option. Unlike [cropping audio clips](#), cropping a MIDI clip does not create a new file on disk.

10.4.11 Deactivating Notes

To deactivate, or mute, a note (or notes) in the MIDI Editor, select it and  (PC) /   (Mac) to access the context menu. The Deactivate Note(s) command will mute the note, making it appear gray in the display. To reactivate notes, use the context menu's Activate Note(s) command. You can de- or reactivate all of the notes in a single key track at once by  (PC) /   (Mac) on a key in the piano roll.

Chapter 11

Using Grooves

The timing and “feel” of each clip in your Set can be modified through the use of *grooves*. Live’s Library includes a large selection of grooves, which appear as .agr files in the Browser.

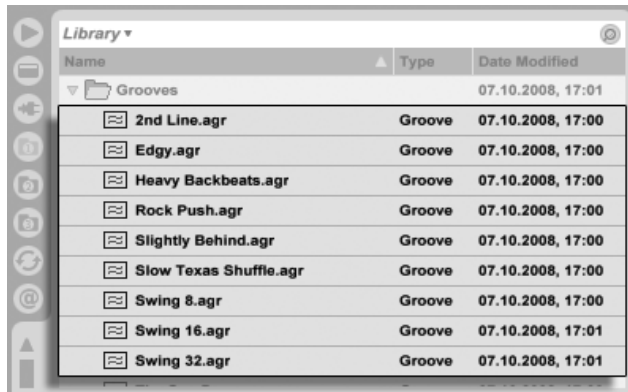

Groove Files in the Browser.

The easiest way to work with Library grooves is to drag and drop them from the Browser directly onto clips in your Set. This immediately applies the timing characteristics of the groove file to the clip. If you want to quickly try out a variety of grooves, you can enable the [Hot-Swap](#) button above a clip’s [Clip Groove chooser](#) and then step through the grooves in

the Browser while the clip plays.



The Hot-Swap Groove Button.

Grooves can be applied to both audio and MIDI clips. In audio clips, grooves work by adjusting the clip's **warping behavior**, and thus only works on clips with Warp enabled.

11.1 Groove Pool

Once you've applied a groove file, you can modify its behavior by adjusting its parameters in the *Groove Pool*, which can be opened or closed via its selector button at the bottom of Browser.



The Groove Pool Selector Button.

You can also double-click grooves in the Browser to load them directly to the Groove Pool before applying them to a clip. The Groove Pool contains all grooves that have been loaded in this way or that are being used in clips. "Inactive" grooves (those that are not being used by a clip) appear with their parameters greyed out.

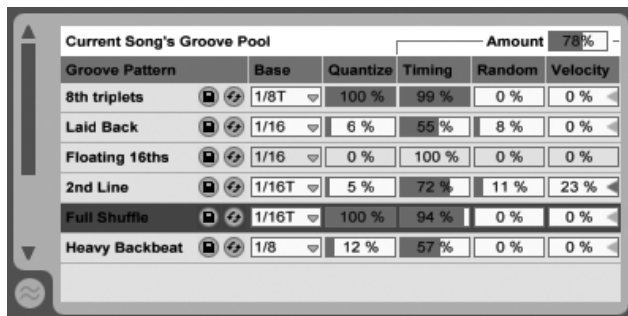

The Groove Pool.

11.1.1 Adjusting Groove Parameters

Grooves in the Groove Pool appear in a list, and offer a variety of parameters that can be modified in real time to adjust the behavior of any clips that are using them. You can also save and hot-swap grooves via the buttons next to the Groove's name.

The Groove Pool's controls work as follows:

- **Base** – The Base chooser determines the timing resolution against which the notes in the groove will be measured. A 1/4 Base, for example, means that the positions of the notes in the groove file are compared to the nearest quarter note, and all notes in any clips that are assigned to that groove will be moved proportionally towards the positions of the groove notes. At a base of 1/8th, the groove's notes are measured from their nearest eighth note. Notes in the groove that fall exactly on the grid aren't moved at all, so the corresponding notes in your clips will also not be moved.
- **Quantize** – adjusts the amount of "straight" quantization that is applied before the groove is applied. At 100%, the notes in your clips will be snapped to the nearest note values, as selected in the Base chooser. At 0%, the notes in clips will not be moved from their original positions before the groove is applied.
- **Timing** – adjusts how much the groove pattern will affect any clips which are using it.
- **Random** – adjusts how much random timing fluctuation will be applied to clips using the selected groove. At low levels, this can be useful for adding subtle "humanization" to highly quantized, electronic loops. Note that Random applies differing randomization

to every voice in your clip, so notes that originally occurred together will now be randomly offset both from the grid and from each other.

- *Velocity* – adjusts how much the velocity of the notes in clips will be affected by the velocity information stored in the groove file. Note that this slider goes from -100 to +100. At negative values, the effect of the groove’s velocity will be reversed; loud notes will play quietly and vice versa.
- *Amount* – this is a global parameter, and scales the overall intensity of Timing, Random and Velocity for all of the available groove files. At 100%, the parameters will be applied at their assigned values. Note that the Amount slider goes up to 130%, which allows for even more exaggerated groove effects.

11.1.2 Committing Grooves



The Commit Groove Button.

Pressing the Commit button below the **Clip Groove chooser** “writes” your groove parameters to the clip. For MIDI clips, this moves the notes accordingly. For audio clips, this creates Warp Markers at the appropriate positions in the clip.



After pressing Commit, the clip’s Groove chooser selection is automatically set to None.

11.2 Editing Grooves

The effect that groove files have on your clips is a combination of two factors: the parameter settings made in the Groove Pool and the positions of the notes in the groove files themselves. To edit the contents of groove files directly, drag and drop them from the Browser

or Groove Pool into a MIDI track. This will create a new MIDI clip, which you can then **edit**, as you would with any other MIDI clip. You can then convert the edited clip back into a groove, via the process below.

11.2.1 Extracting Grooves

The timing and volume information from any audio or MIDI clip can be extracted to create a new groove. You can do this by dragging the clip to the Groove Pool or via the Extract Groove command in the clip's  (PC) /  (Mac) context menu.



*Extract Grooves From
Audio or MIDI Clips.*

Grooves created by extracting will only consider the material in the playing portion of the clip.

11.3 Groove Tips

This section presents some tips for getting the most out of grooves.

11.3.1 Grooving a Single Voice

Drummers will often use variations in the timing of particular instruments in order to create a convincing beat. For example, playing hi-hats in time but placing snare hits slightly behind the beat is a good way of creating a laid-back feel. But because groove files apply to an entire clip at once, this kind of subtlety can be difficult to achieve with a single clip. Provided your clip uses a Drum or Instrument Rack, one solution can be to **extract the chain** containing

the voice that you want to independently groove. In this example, we'd extract the snare chain, creating a new clip and track that contained only the snare notes. Then we could apply a different groove to this new clip.

11.3.2 Non-Destructive Quantization

Grooves can be used to apply real-time, non-destructive quantization to clips. To do this, simply set the groove's Timing, Random and Velocity amounts to 0% and adjust its Quantize and Base parameters to taste. With only Quantize applied, the actual content of the groove is ignored, so this technique works the same regardless of which Groove file you use.

11.3.3 Creating Texture With Randomization

You can use a groove's Random parameter to create realistic doublings. This can be particularly useful when creating string textures from single voices. To do this, first duplicate the track containing the clip that you want to "thicken." Then apply a groove to one of the clips and turn up its Random parameter. When you play the two clips together, each note will be slightly (and randomly) out of sync with its counterpart on the other track.

Chapter 12

Launching Clips

The Live Session View is set apart by the fact that it gives you, the musician, a spontaneous environment that encourages performance and improvisation. An important part of how you take advantage of the Session View lies within how you configure your various Session View clips. This chapter explains the group of settings used to define how each Session View clip behaves when triggered, or “launched.”

12.1 The Launch Box

Remember that clips in the Session View are launched by their **Clip Launch buttons** or **remote control**. Clip launch settings are made in the *Launch box*. The Launch box only applies to Session View clips, as Arrangement View clips are not launched but played according to their positions in the Arrangement.

To view the Launch box, open the **Clip View** of a Session View clip by double-clicking the clip, then activating the leftmost Clip View Box selector panel.



Use the Clip View Box Selector to Bring up the Launch Box.

Note that you can edit the launch settings of more than one clip at the same time by first selecting the clips and then opening the Clip View.

12.2 Launch Modes



The Clip Launch Mode Chooser.

The Launch Mode chooser offers a number of options for how clips behave with respect to mouse clicks, **computer keyboard actions** or **MIDI notes**:

- **Trigger**: *down* starts the clip; *up* is ignored.
- **Gate**: *down* starts the clip; *up* stops the clip.
- **Toggle**: *down* starts the clip; *up* is ignored. The clip will stop on the next down.
- **Repeat**: As long as the mouse switch/key is held, the clip is triggered repeatedly at the clip quantization rate.

12.3 Clip-Level Quantization

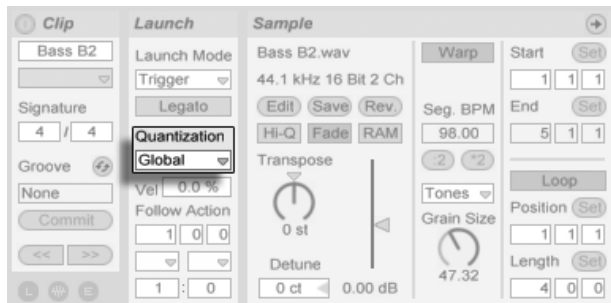

The Clip Quantization Chooser.

The Clip Quantization chooser lets you adjust an onset timing correction for clip triggering. To disable clip quantization, choose “None.”

To use the Control Bar’s Global Quantization setting, choose “Global.” Global quantization can be quickly changed using the **Ctrl** **6** (PC) / **⌘** **6** (Mac), **7**, **8**, **9** and **0** shortcuts.

Note that any setting other than “None” will quantize the clip’s launch when it is triggered by [Follow Actions](#).

12.4 Velocity

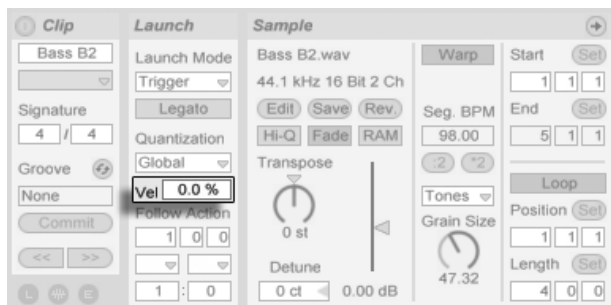

The Velocity Amount Field.

The Velocity Amount control allows you to adjust the effect of MIDI note velocity on the clip's volume: If set to zero, there is no influence; at 100 percent, the softest notes play the clip silently. For more on playing clips via MIDI, see the [respective section](#).

12.5 Legato Mode



The Legato Mode Switch.

Suppose you have gathered, in one track, a number of looping clips, and you now want to toggle among them without losing the sync. For this you could use a large quantization setting (one bar or greater), however, this might limit your musical expression.

Another option, which works even with quantization turned off, is to engage *Legato Mode* for the respective clips. When a clip in Legato Mode is launched, it takes over the play position from whatever clip was played in that track before. Hence, you can toggle clips at any moment and rate without ever losing the sync.

Legato Mode is very useful for creating breaks, as you can momentarily play alternative loops and jump back to what was playing in the track before.

Unless all the clips involved play the same sample (differing by clip settings only), you might hear dropouts when launching clips in Legato Mode. This happens because you are unexpectedly jumping to a point in the sample that Live has had no chance to pre-load from disk in advance. You can remedy this situation by engaging [Clip RAM Mode](#) for the clips in question.

12.6 Follow Actions

Follow Actions allow creating chains of clips that can trigger each other in an orderly or random way (or both). A clip's *Follow Action* defines what happens to other clips in the

same group after the clip plays. A group is defined by clips arranged in successive slots of the same track. Tracks can have an unlimited number of groups, separated by empty slots.

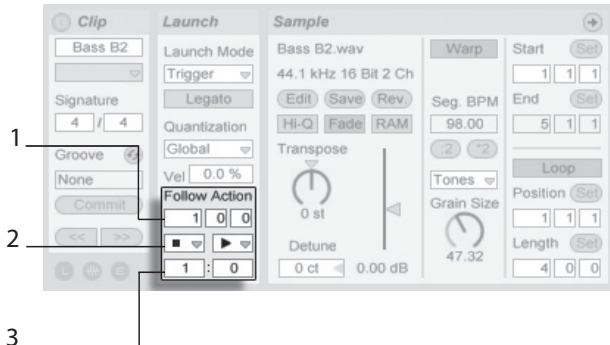

The Follow Action Controls.

1. The Follow Action Time control defines when the Follow Action takes place in bars-beats-sixteenths from the point in the clip where play starts. The default for this setting is one bar.
2. The Follow Action choosers allow selecting two different Follow Actions, A and B.
3. The Chance A and Chance B controls set the likelihood of each of the two Follow Actions occurring. If a clip has Chance A set to 1 and Chance B set to 0, Follow Action A will occur every time the clip is launched. As we can see from this example, a Chance setting of 0 means that an action will never happen. Changing Chance B to 10 in this scenario makes Follow Action A occur much less often – approximately once out of every ten clip launches.

There are eight Follow Actions available:

- “Stop” simply stops the clip after it has played for the chosen Follow Action Time. Note that this overrides clip loop/region settings.
- ▶ “Play Clip Again” restarts the clip.
- ⬆ “Play Previous Clip” triggers the previous clip (the one above the current one).
- ⬇ “Play Next Clip” triggers the next clip down in the group. If a clip with this setting is last in a group, this Follow Action triggers the first clip.

☰ “Play First Clip” launches the first (top) clip in a group.

☰ “Play Last Clip” launches the last (bottom) clip in a group.

* “Play Any Clip” plays any clip in the group.

⌘ “Play Other Clip” is similar to “Play Any Clip,” but as long as the current clip is not alone in the group, no clip will play consecutively.

There is also the possibility to have no Follow Action by selecting “No Action,” or leaving the chooser blank.

Note that a Follow Action happens exactly after the duration that is specified by the Follow Action Time controls *unless* clip quantization is set to a value other than “None” or “Global.” Follow Actions circumvent global quantization *but not* clip quantization.

So why do you need these things? Music is repetition and change. Music based on loops or short melodic fragments has a tendency to sound static. Follow Actions allow you to create structures that will repeat but can also be surprising. Remember that you can always **record** the results of your experiments, so this can provide a good source for new material.

In the following sections we will look at some practical examples and ideas for Follow Actions.

12.6.1 Looping Parts of a Clip

Let’s say that you want to play a longer clip, but then you want only the last eight bars to loop. You can set this up using Follow Actions:

1. Drag the clip into the Arrangement View and make sure that the Clip View’s Loop switch is not activated. Use the Edit menu’s **Split command** to split the clip between the non-looping and looping parts.
2. Click and drag the resulting two clips into the Session View by letting the mouse cursor hover over the Session View selector. Drop the two clips into a track. They now form a Follow Action group.

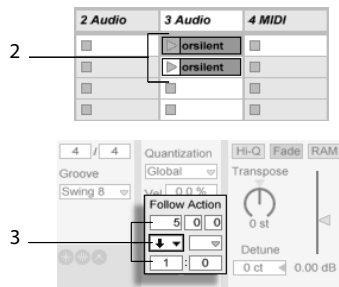

Creating a Group With the Two Clips.

3. Set up Follow Actions for the first clip. You will want to make Follow Action Time equal to the clip's length. Set the Follow Action A chooser to "Play Next Clip," with a Chance setting of 1, leaving Follow Action B alone. Now this clip is set up to advance to the looping clip after it plays.
4. Activate the Loop switch for the second clip.

The first clip will now proceed to the second after it has played in its entirety; the second clip will simply play in a loop until it is stopped.

12.6.2 Creating Cycles

One of the most obvious possibilities that Follow Actions open up is using a group of samples to form a musical cycle. If we organize several clips as a group and use the "Play Next Clip" Follow Action with each clip, they will play one after the other ad infinitum, or until we tell them to stop.

Cycles can be peppered with occasional rearrangements through the addition of other Follow Actions, such as "Play Any Clip," with smaller relative Chance settings.

12.6.3 Temporarily Looping Clips

There are some interesting applications of Follow Actions when it comes to creating temporary musical loops.

The default setting for Follow Action is actually a 1:0 chance that “Nothing” happens after the Follow Action Time, which means that there is effectively no Follow Action. But now, imagine a group consisting of one single clip. Follow Action A is set to “Play Clip Again,” with a Chance of 8. Follow Action B is set to “None,” with a Chance of 1. The clip uses a long sample, and Follow Time is set to one bar. Clicking on the clip will play the first bar, after which it will be very likely that it will play the first bar again. However, after a few repetitions, it will eventually come to Action B – “Nothing” – and continue playing the rest of the sample.

Or, a clip can be played from its start to a specific point, when its Follow Action tells it to “Play Next Clip.” The same file can be used in the next clip in the group, but this one can be set to loop. This second clip can have any manner of Follow Action settings, so that it might then play forever, for a specified time or until random chance leads to the next clip in the group.

12.6.4 Adding Variations in Sync

Paired with [clip envelopes](#) and [warping](#), Follow Actions can be used to create all sorts of interesting variations within a group of similar clips. You could, for example, use Follow Actions to randomly trigger clips with different MIDI controller clip envelopes, so that fine variations in pitch bend or modulation of an instrument or synth could occur as the clips in a group interacted. Audio clips could morph between different effect or clip transposition settings.

Using Follow Actions and Legato Mode together provides a powerful way of gradually changing a melody or beat. Imagine that you have several identical clips of a melody that form a group, and they are set up to play in [Legato Mode](#). Whenever their Follow Actions tell them to move on to another clip in the group, the melody will not change, as Legato Mode will sync the new play position with the old one in beat-time. The settings and clip envelopes of each clip (or even the actual notes contained in a MIDI clip) can then be slowly adjusted, so that the melody goes through a gradual metamorphosis.

12.6.5 Mixing up Melodies and Beats

You can let Follow Actions perform unpredictable remixes and solos for you: Use a clip containing a beat or melody, and copy it so that there are several instances of it forming a group. Alternatively, you can use several different beats or melodies that you want to mix together. The **start and end** for each clip can be set differently, as can **clip envelopes** and other clip settings. As long as Follow Action Time in each clip is equal to the length of the clip that you want to play, you can set up two Follow Actions with different Chance values in each clip, launch a clip, and surprise yourself.

12.6.6 Creating Nonrepetitive Structures

Follow Actions are great when it comes to sound installations, as they allow you to create structures that play for weeks or months and never exactly repeat. You can set the Follow Action Time controls in a series of clips to odd intervals, and the clips will interact with each other so that they never quite play in the same order or musical position. Remember that each clip can have two different Follow Actions with corresponding Chance settings... have fun!

Chapter 13

Routing and I/O

In the context of Live, “routing” is the setup of the tracks’ signal sources and destinations (i.e., their inputs and outputs). Most routing happens in the mixer’s *track In/Out* section, which offers, for every track, choosers to select a signal source and destination. The mixer’s In/Out section is Live’s “patchbay.”

The In/Out section can be independently shown or hidden from the Session and Arrangement Views. Toggle its visibility using the I/O Mixer Section selector, or via the View menu’s In/Out option.



The Mixer’s In/Out Section and Mixer Section Selectors.

For every track that can play clips, the In/Out section has the same layout:

- The upper chooser pair (“Audio/MIDI From”) selects the track’s input. Audio tracks have an audio input, and MIDI tracks have a MIDI input. Return tracks receive their input from the respective **sends**.
- The Monitor radio button selects the monitor mode: the conditions under which the track’s input is heard through the track.
- The lower chooser pair (“Audio/MIDI To”) selects the track’s output. All tracks have audio outputs, except for MIDI tracks without instruments. Remember that **instruments convert MIDI to audio**.

Within a chooser pair, the upper chooser selects the signal category (“Ext.,” for instance, for external connections via an audio or MIDI interface), and is called the Input/Output Type chooser. If this signal type offers sub-selections or channels, they are available from the lower chooser, or the Input/Output Channel chooser. In our “Ext.” example, these would be the individual audio/MIDI inputs and outputs.

13.1 Monitoring

“Monitoring,” in the context of Live, means passing a track’s input signal on to the track’s output. Suppose you have set up an audio track to receive its input signal from a guitar. Monitoring then means that the signal from your live guitar playing actually reaches the track’s output, via the track’s device chain. If the track’s output is set to “Master,” you can hear the guitar signal, processed by whatever effects are used (and delayed by whatever latency the audio hardware interface incurs), over your speakers.

The In/Out section offers, for every audio track and MIDI track, a *Monitor* radio button with the following three options:

- The default *Auto-monitoring* setting does the right thing for most straightforward recording applications: Monitoring is on when the track is **armed (record-enabled)**, but monitoring is inhibited as long as the track is playing clips.

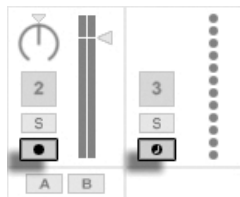

Audio and MIDI Track Arm Buttons.

- To permanently monitor the track's input, regardless of whether the track is armed or clips are playing, choose *In*. This setting effectively turns the track into what is called an "Aux" on some systems: the track is not used for recording but for bringing in a signal from elsewhere (for instance, a ReWire slave program). With this setting, output from the clips is suppressed. An "In" monitoring setting can be easily recognized even when the In/Out section is hidden by the orange color of the track's Activator switch.
- Monitoring can be turned off altogether by choosing the *Off* option. This is useful when recording acoustic instruments which are monitored "through the air," when using an external mixing console for monitoring or when using an audio hardware interface with a "direct monitoring" option that bypasses the computer so as to avoid latency. Generally, it is preferable to work with an audio interface that allows for negligible latencies (a few milliseconds). If you are recording into Live with monitoring set to "Off," you may want to make the Audio Preferences' Overall Latency adjustment, which is described in the built-in program tutorial on setting up the Audio Preferences.

If multiple tracks are selected, pressing one of the Monitor buttons applies this selection to all of the selected tracks.

13.2 External Audio In/Out

An audio interface's inputs are selected by choosing "Ext. In" from the Input Type chooser of an audio track. The Input Channel chooser then offers the individual input channels. Entries in this chooser each have meters next to their names to help you identify signal presence and overload (when the meter flashes red). Setting up the audio interface's outputs works the same way via the output chooser pair. If multiple tracks are selected, any changes you make to these choosers will be applied to all selected tracks.

The list of available inputs and outputs depends on the Audio Preferences, which can be

reached via the Input and Output Channel choosers' "Configure..." option. Note that the Audio Preferences also provide access to the Channel Configuration dialogs, which determine which inputs and outputs are used, and whether they are available to Live as mono or stereo pairs. Essentially, the Channel Configuration dialog tells Live what it needs to know about how the computer is connected to the other audio components in your studio.

13.2.1 Mono/Stereo Conversions

When a mono signal is chosen as an audio track's input, the track will record mono samples; otherwise it will record stereo samples. Signals in the track's device chain are always stereo, even when the track's input is mono or when the track plays mono samples.

Mono is turned into stereo simply by using the identical signal for left and right channels. When a track is routed into a mono output, the left and right signals are added together and attenuated by 6 dB to avoid clipping.

13.3 External MIDI In/Out

MIDI from the outside world is routed into Live just like audio. From the Input Type chooser of a MIDI track, you can either select a specific MIDI input port or "All Ins," which is the merged input of all external MIDI ports. The Input Channel chooser offers the individual input channels of the selected MIDI port and the merged signal of all channels, "All." As is the case with audio inputs, the Input Channel chooser also has meters next to every entry to represent activity on the respective input channel. If multiple MIDI tracks are selected, any changes you make to these choosers will be applied to all selected tracks.



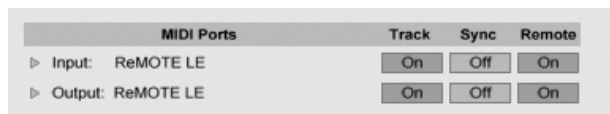

13.3.1 The MIDI Ports List in the Preferences



The MIDI Ports List in the Preferences.

You can configure which MIDI ports are made available to Live using the *MIDI Ports* section of the MIDI/Sync Preferences. All available input and output ports are listed here. For Live's tracks to receive/send MIDI from/to a specific MIDI port, the corresponding switch in the Track column must be set to *On*. You can use any number of MIDI ports for track input and output; the mixer's In/Out choosers allow them to be addressed individually.

13.3.2 Playing MIDI With the Computer Keyboard

The computer keyboard can be used for generating MIDI notes from computer keyboard strokes. To turn the computer MIDI keyboard on, use the Control Bar's Computer MIDI Keyboard button, or the   K (PC) /   K (Mac) shortcut to the Options menu entry.



Activating the Computer MIDI Keyboard.

The center row of letter keys on the keyboard will play notes corresponding to the white keys on a piano, beginning on the left with the note C3. The black keys on a piano correspond to the upper row of computer keys. The five leftmost letters on the lower row of the keyboard (Z, X, C, V, and B on a U.S.-English keyboard) are used to transpose the note range and to set velocity, as follows:

- The leftmost keys (Z and X) adjust the keyboard's octave range.
- The next two keys (C and V) adjust incoming note velocity by intervals of twenty (20, 40, 60, and so on).
- The fifth key from the bottom left (B) places an "accent" on incoming MIDI notes. This key boosts note velocity by 20 as long as it is held down. Once it is released, however, velocity will drop back to its original value. If your keyboard is already set to input notes at 120, holding this key will raise note velocity to 127.

As it happens, when the computer keyboard is set to send notes between C3 and C4, the keys are mapped to MIDI notes such that the center row of the keyboard (ASDF...) addresses the **Impulse percussion sampler's sample slots**. This means that you can play and record drum patterns right off the computer keyboard.

Note that when the computer MIDI keyboard is activated, it will "steal" keys that may have

otherwise been assigned to **remote-control** elements of the Live interface. To prevent this, you can turn the computer MIDI keyboard off when it is not needed.

13.3.3 Connecting External Synthesizers

Routing MIDI to an external synthesizer is straightforward: The Output Type chooser is set to whatever MIDI port the synthesizer is connected to; the Output Channel chooser is used to select which MIDI channel to send on.

In addition to routing via a track's In/Out section, it is also possible to route from within a track's device chain by using the **External Instrument** device. In this case, you can send MIDI out to the external synthesizer and return its audio - all within a single track.

Important: If you are using a keyboard synthesizer both as a master keyboard to play into Live and as a sound generator, then please make sure to check the synthesizer's "Local Off" function. Every synthesizer has this function, which effectively separates the keyboard from the sound generator, allowing you to treat both components as if they were separate devices. This allows you to use Live as the hub of your MIDI studio, which receives MIDI from the keyboard and dispatches the incoming MIDI, as well as the MIDI from the clips, as appropriate.

13.3.4 MIDI In/Out Indicators

Live's Control Bar contains three pairs of indicator LEDs that tell you about incoming and outgoing MIDI. These indicators tell you not only about the presence of signals, but also about their use. In every pair, the upper indicator flashes when a MIDI message is received, and the lower indicator flashes when a MIDI message is sent.



The Control Bar's MIDI Indicators.

The three indicator pairs represent, from left to right:

1. MIDI Clock and Timecode signals that are used for **synchronizing Live with other sequencers**. Note that this set of indicators is only visible when an external sync source has been enabled in the MIDI Ports List in the Preferences;

2. MIDI messages that are used for remote-controlling Live's user-interface elements;
3. MIDI messages coming from and going to Live's MIDI tracks.

MIDI messages that are mapped to remote-control Live's user-interface elements are "eaten up" by the remote control assignment and will not be passed on to the MIDI tracks. This is a common cause of confusion that can be easily resolved by looking at the indicators.

13.4 ReWire Slave Routing

Live can operate as a ReWire master or slave in cooperation with another ReWire application. As a ReWire master, Live can send MIDI to, and receive audio from, any ReWire slave application installed on the same computer.

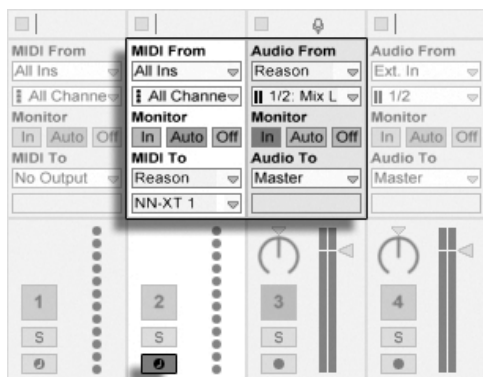

An Audio Track
Receiving Audio From
and a MIDI Track
Sending MIDI to Reason.

The following example shows how to send MIDI from one of Live's MIDI tracks into an instrument within *Propellerhead's Reason*, and then route the audio result back into an audio track:

1. First, start Live.
2. Then, start Reason and set up the Reason rack as desired.
3. Select "Reason" from the MIDI track's Output Type chooser.

4. The Output Channel chooser presents you with a list of the instruments that you currently have in your Reason rack; select the instrument you want to address.
5. Select “Reason” from the audio track’s Input Type chooser.
6. From the audio track’s Input Channel chooser, select the audio channel that corresponds to the instrument to which you are sending MIDI.
7. Set the audio track’s Monitor radio button to “In.”
8. Select “All Ins” from the MIDI track’s Input Type chooser.
9. Arm the MIDI track.

Now, any MIDI that you are playing into Live will arrive in Reason, which will generate the corresponding audio back into the audio track, ready for further processing in Live’s mixer and effects. If you want to continue work on the project without reopening Reason, simply record Reason’s audio by arming the audio track and engaging Record Mode.

A similar procedure is possible with the [External Instrument](#) device. The following example shows how to send MIDI from within a track’s device chain and return the audio to the same track:

1. *First*, start Live.
2. *Then*, start Reason and set up the Reason rack as desired.
3. Insert an External Instrument device into a MIDI track.
4. Select “Reason” from the External Instrument’s first MIDI To chooser.
5. The second chooser presents you with a list of the instruments that you currently have in your Reason rack; select the instrument you want to address.
6. From the External Instrument’s Audio From chooser, select the audio channel that corresponds to the instrument to which you are sending MIDI.
7. Arm the MIDI track.
8. Adjust the External Instrument’s Gain knob as necessary.

13.5 Resampling

Live's Master output can be routed into an individual audio track and recorded, or *resampled*. Resampling can be a fun and useful tool, as it lets you create samples from what is currently happening in a Live Set that can then be immediately integrated. It can be used to record tracks that include processor-intensive devices, so as to delete the devices, or for quickly previewing before [rendering to disk](#).

The "Resampling" option in any audio track's Input Type chooser will route the Master output to that track. You can then decide on what exactly you will be resampling and mute, solo or otherwise adjust the tracks that are feeding the Master output. You will probably want to use the Master Volume meter to make sure that your level is as high as possible without clipping (indicated by red in the meter). Then you can arm the track and [record into any of its empty clip slots](#). Note that the recording track's own output will be suppressed while resampling is taking place, and will not be included in the recording.

Samples created by resampling will be stored in with the current Set's [Project folder](#), under Samples/Recorded. Until the Set is saved, they remain at the location specified by the [Temporary Folder](#).

13.6 Internal Routings

Live's mixer and external routing devices allow for inter-track routings. These routings, albeit potentially confusing, enable many valuable creative and technical options. Via the mixer, inter-track routing can work two ways:

1. Track A is set up to send its output signal to Track B. This is possible because every track that can receive an output signal of the appropriate type from Track A shows up in its Output Type chooser.
2. Track B is set up to receive its input signal from Track A. This works because every track that delivers a signal of the appropriate type appears in Track B's Input Type chooser.



Two Ways to Route Track A into Track B.

Both approaches result in Track A's output being fed into Track B. Approach 1 leaves Track B's in/out settings alone, and we can, at any time, add more tracks that feed their output into Track B. This is the method of choice for "many-to-one" routings such as submixes or several MIDI tracks playing the same instrument. In this scenario, soloing Track B will still allow you to hear the output of the tracks that are feeding it. Also, you can still solo Track A and hear its output signal. In this case, all other tracks are muted, including those that might also feed into Track B. Technically, what you hear is the output of Track B, with everything except Track A's signal removed.

Approach 2, on the other hand, leaves Track A unaffected except for Track B tapping its output. We can easily add more tracks like Track B that all tap Track A's output. Instrument layering is a good example of such a "one-to-many" routing setup.

13.6.1 Internal Routing Points

Signals travel from Live's tracks into their respective device chains and then into the track mixer, where they might become panned or have their levels altered by the tracks' faders.

Whenever a track's Audio From input chooser is set to another track (as described in the previous section's Approach 2), the signal received can be tapped from one of three different points chosen from the Input Channel chooser: *Pre FX*, *Post FX* or *Post Mixer*.



Tap Points for Track Routing.

- *Pre FX* taps the signal that is coming directly from a track, before it has been passed on to the track's device chains (FX) or mixer. Therefore, changes that are made to the tapped track's devices or mixer have no effect on the tapped signal. Soloing a track that taps another track *Pre FX* will allow you to hear the tapped track.
- *Post FX* taps the signal at the output of a track's device chains (FX), but before it has been passed back to the track mixer. Changes to the tapped track's devices will therefore alter the tapped signal, but changes to its mixer settings will not. Soloing a track that taps another track *Post FX* will allow you to hear the tapped track.
- *Post Mixer* taps the final output of a track, after it has passed through its device chains and mixer. Soloing a track that taps another track *Post Mixer* will *not* allow you to hear the tapped track.

Routing Points in Racks

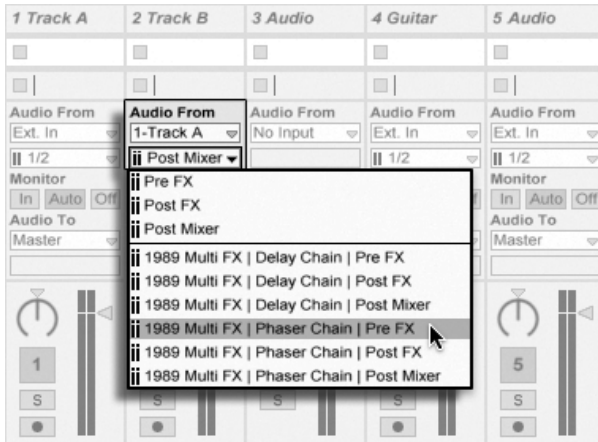

Tap Points for Every Chain in a Track.

If a track has one or more **Instrument or Effect Racks** in its device chain, internal routing points (Pre FX, Post FX and Post Mixer) will also be available for every chain within the Rack. If a track contains one or more **Drum Racks**, internal routing points will be available for any of the Rack's return chains. Each Rack will also be listed in the Input Channel chooser:

- *(Rack Name) | (Chain Name) | Pre FX* – The signal will be tapped from the point that it enters the Rack, before it reaches the chain's devices.
- *(Rack Name) | (Chain Name) | Post FX* – The signal will be tapped from the end of the chain, but before it passes to the chain's mixer.
- *(Rack Name) | (Chain Name) | Post Mixer* – The signal will be tapped from the output of the chain's mixer, just before the point where all of the chains in the Rack are summed together to create the Rack's output.

Soloing a track that taps a Chain at any of these points will still allow you to hear the output at that point.

13.6.2 Making Use of Internal Routing

This section presents several internal routing examples in more detail.

Post-Effects Recording

Let's say that you are feeding a guitar into Live, building up a song track by track, overlaying take onto take. It is certainly powerful to have a separate effects chain per track for applying different effects to different takes – after the fact. You might, however, want to run the guitar signal through effects (a noise gate or an amp model, for instance) *before* the recording stage, and record the post-effects signal.



An Example Setup for Post-Effects Recording.

This is easily accomplished by devoting a special audio track for processing and monitoring the incoming guitar signal. We call this track “Guitar” and drag the desired effects into its device chain. We do not record directly into the Guitar track; instead we create a couple more tracks to use for recording. Those tracks are all set up to receive their input Post FX from the Guitar track. Note that we could also tap the Guitar track Post Mixer if we wished to record any level or panning from it.

As for monitoring, we set the Guitar track’s Monitor radio button to In, because we always want to listen to our guitar through this track, no matter what else is going on in Live. The other tracks’ Monitor radio buttons are set to Off.

Recording MIDI as Audio

When working with MIDI and complex software instruments, it is sometimes more useful to record the resulting audio than the incoming MIDI. A single MIDI note can prompt, for example, Native Instruments' *Absynth* to produce something that sounds more like a piece of music than a single tone. This output lends itself more to representation as an audio waveform than a single note in a MIDI clip, particularly when comparing the editing options.

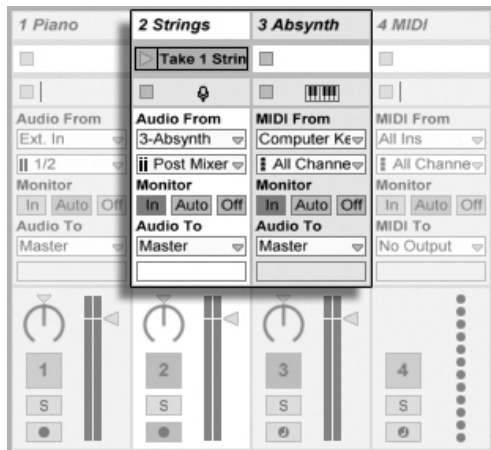

Recording the Output of a Complex Instrument in Audio Tracks.

A setup similar to the one described [above](#) accomplishes the task. We have one MIDI track hosting the virtual instrument, and we use additional audio tracks to record the audio result of playing the instrument.

Creating Submixes

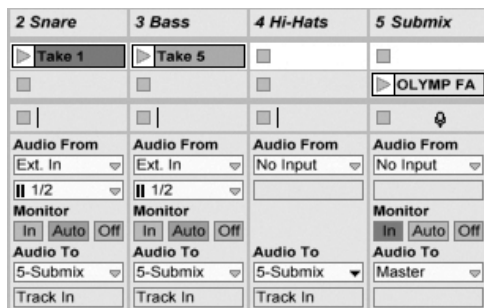

Submixing the Individual Drums of a Drum Kit.

Suppose we have the individual drums of a drum kit coming in on separate tracks for multitrack recording. In the mix, we can easily change the volumes of the individual drums, but adjusting the volume of the entire drum kit against the rest of the music is less convenient. Therefore, we add a new audio track to submix the individual drums. The drum tracks are all set to output to the submix track, which outputs to the Master. The submix track gives us a handy volume control for the entire drum kit.

Alternatively, you could combine the separate drum tracks into a **Group Track** for even more flexibility. This automatically creates the necessary output routings and also allows you to hide or show the component tracks.

Several MIDI Tracks Playing the Same Instrument

Consider a MIDI track containing a virtual instrument – a **Simpler** playing a pad sound, for example. We have already recorded MIDI clips into this track when we realize that we would like to add an independent, parallel take for the same instrument. So we add another MIDI track. We could now drag another **Simpler** into the new track, but we would really like to reuse the **Simpler** from the pad track, so that changing the pad's sound affects the notes from both tracks.

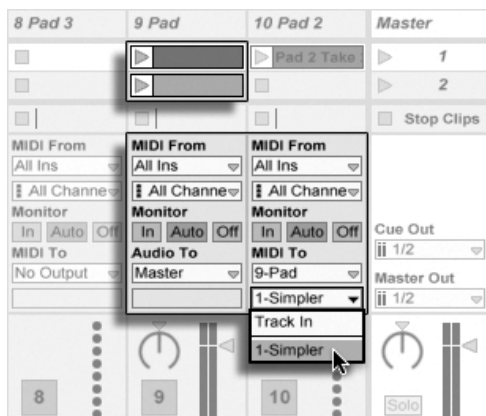

Feeding an Additional MIDI Track Into an Existing MIDI Track to Reuse its Instrument.

This is accomplished by setting the new MIDI track's Output Type chooser to "Pad." Note that the Output Channel chooser now offers a selection of destinations: We can either feed the new track's output into the input of the pad track, or we can directly address the Simpler. The "Track In" option in the Output Channel represents the pad track's input signal (the signal to be recorded), which is not what we want. We instead select "Simpler Ch. 1" to send the new track's MIDI directly to the Simpler, bypassing the recording and monitoring stage. With this setup, we can choose to record new takes on either track and they will all play the same pad sound.



The Instrument Has Been Isolated in a Dedicated Track.

We might be bothered by the fact that muting the pad track (by turning off its Activator switch) also mutes the other MIDI track. To be precise, the other track keeps playing, but its

MIDI is played by an instrument that is out of the mix. This can be easily remedied by cutting the clips from the pad track and pasting them into a third track that can be independently muted (and that can hold its own MIDI effects). The original pad track now acts as a mere instrument container. As we are not recording new clips into this track, we can set its Input Type chooser to “No Input,” which makes its Arm button disappear and helps to avoid confusion when the mixer’s In/Out section is hidden.

Tapping Individual Outs From an Instrument

Some software instruments, like Live’s **Impulse percussion sampler**, offer multiple audio outputs for the signals they produce. By default, Impulse mixes the output of its eight sample slots internally and delivers the mix at the instrument’s audio out. Any audio effects following Impulse in the same track process the composite signal. Sometimes it is desirable to take an individual drum sound out of the mix for individual effects processing and mixing. This is possible because Impulse offers its sample slots as audio sources to other tracks.

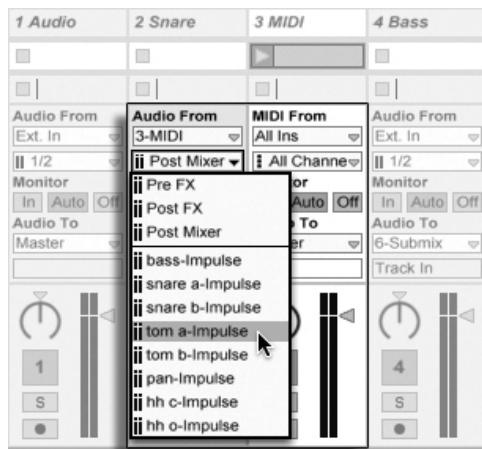

Using Impulse’s Individual Outs to Separately Process Sample Slots.

We simply create an audio track and select from its Input Type chooser the track with the Impulse. The Input Channel chooser now offers, in addition to *Pre FX*, *Post FX* and *Post Mixer*, Impulse’s eight individual outputs, labeled according to the sample used in each slot. Notice that routing an individual output from Impulse into another track automatically takes this signal out of Impulse’s own internal mix. This convenience is not standard behavior of

most plug-in instruments, however. Soloing a track that taps one of Impulse’s sample slots will still allow you to hear the output of that slot.

Using Multi-Timbral Plug-In Instruments

Many plug-in instruments support multi-timbral operation. A multi-timbral instrument is like several instruments in one, with each component “part” (or whatever term the manufacturer uses) receiving MIDI on a separate MIDI channel. Usually, the multi-timbral instrument offers individual outputs so that the parts can be separately routed into the mixer. Or, the instrument might offer a submixer of its own.

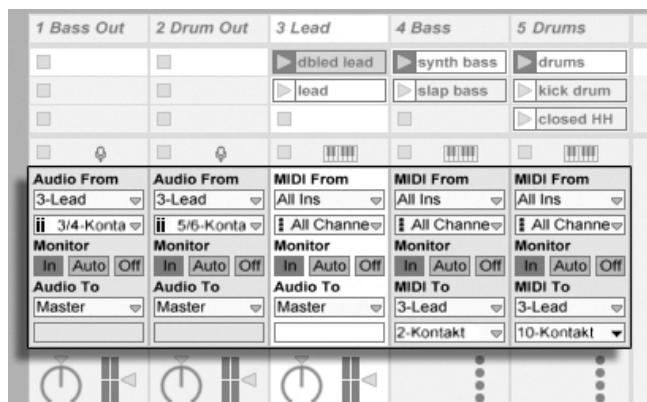

Tracks Feeding MIDI to and Tapping Audio From the Parts of a Multi-Timbral Instrument.

Sending MIDI from the mixer to a multi-timbral instrument is a variation of a case described [above](#). One MIDI track hosts the multi-timbral instrument, and additional MIDI tracks are used to feed its individual parts. Each additional MIDI track has its Output Type chooser pointed to the track that contains the instrument, and its Output Channel chooser referencing the target MIDI channel. Additional audio tracks can then be used to tap the instrument’s individual outputs, as described [earlier](#).

It is also possible to use the External Instrument device to route MIDI to (and audio from) the secondary outputs on multi-timbral plug-ins. This scenario eliminates the need to create an additional audio track for each tapped output:

1. Insert the multi-timbral instrument on a MIDI track.

2. Insert an External Instrument device on another MIDI track.
3. Select the track that contains the instrument in the first MIDI To chooser on the External Instrument device.
4. Select the MIDI channel to route to in the second chooser on the External Instrument device.
5. From the External Instrument's Audio From chooser, select a secondary output on the instrument to which you are sending MIDI.

Repeat steps 2-5 to feed and tap additional components of your multi-timbral instrument. You could also put the entire system of External Instrument devices into a single track, by placing each one in a Rack's device chain.

Note that the main outputs of the multi-timbral instrument will still output to the track that contains the instrument - only auxiliary outputs are available to the External Instrument device.

Feeding Sidechain Inputs

Some effects have so-called "sidechain inputs." A vocoder, for instance, imposes spectral characteristics taken from one signal (say, spoken word) onto another signal, for instance a string pad. The vocoder is inserted as an audio effect into the string track. It has a sidechain input for the speech signal, which has to be delivered from another track. So, we create an additional audio track named "Speech" and set its Output Type chooser to the "Strings" track. From the Output Channel chooser, we select the vocoder's sidechain input.



Routing a Speech Signal Into a Vocoder's Sidechain Input.

Some vocoder plug-ins include a built-in synthesizer to generate the “carrier” signal. In this case, the only difference from the above procedure is that the vocoder instrument is dragged into a MIDI track. Feeding the side-chain audio input works as described above.

Please note that Ableton’s [Auto Filter](#), [Compressor](#), [Gate](#) and [Vocoder](#) devices have their own sidechain controls with integrated routing choosers that match those found in tracks. Thus when using these devices, it is not necessary to follow the above procedure - you can simply select the sidechain source from within the device itself.

Layering Instruments

Suppose that we have a MIDI track containing an instrument playing a string sound, which we would like to augment by adding a brass sound playing the same notes. This can be easily done by adding a MIDI track that contains an instrument playing the brass sound and setting its Input Type chooser to tap the string track’s Post FX signal.

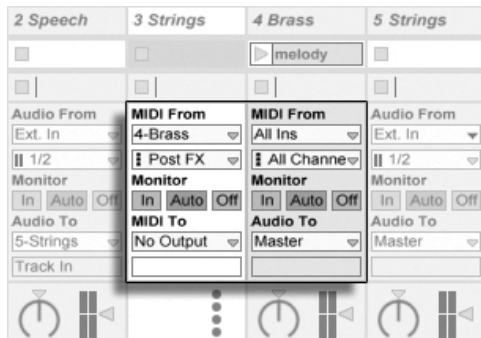

Using an Auxiliary MIDI Track to Layer Instruments.

Perhaps you wonder why this works, given that the string track's output is audio and not MIDI. When routing MIDI in from another track, we are tapping the MIDI at the latest possible stage, which is after any MIDI Effects, and just before the instrument.

Chapter 14

Mixing

14.1 The Live Mixer

Live includes a mixer section that is accessible from two views:

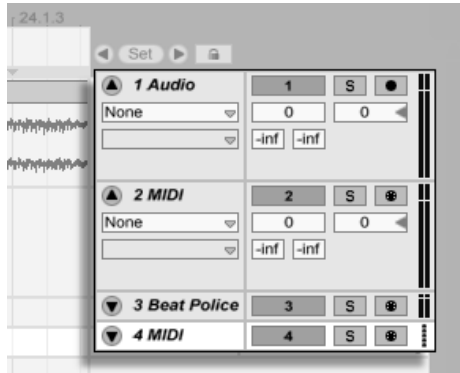

The Arrangement View Mixer.

In the Arrangement View, the mixer appears as a horizontal strip to the right of the track area. To display all mixer controls for a track, unfold the track using the ▾ button next to its name, and adjust its height accordingly.

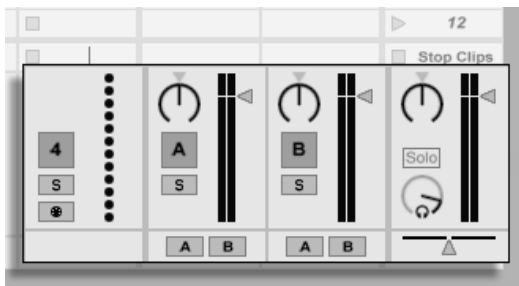

The Session View Mixer.

The Session View is a standard vertical mixer layout. You'll likely find the Session View mixer more intuitive than the Arrangement mixer, which comes in handy when you work with **automation**. Note that the Tab key toggles between the Arrangement and Session Views.

The View menu options listed below show or hide mixer components. You can use different mixer view setups in the Session View and in the Arrangement View:

- In/Out
- Sends
- Returns
- Mixer
- Track Delays
- Crossfader

The Mixer Section selectors on the right-hand side of the screen duplicate the View Menu commands, making it possible to quickly show or hide different mixer components.

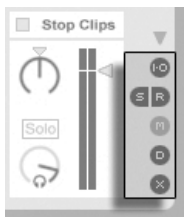

The Mixer Section Selectors.

Let's look at the mixer controls:

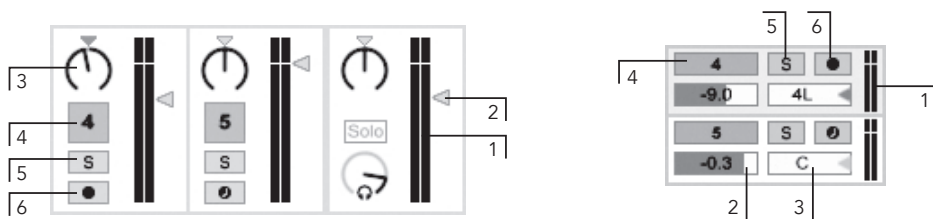

The Mixer Controls.

1. The Meter shows the track's RMS (average) and peak output level. While monitoring, however, it shows the input level.
2. The Volume control adjusts the track's output level. With multiple tracks selected, adjusting the volume of one of them will adjust the others as well.
3. The Pan control positions the track's output in the stereo field. To reset the Pan control to center, click on its associated triangle. With multiple tracks selected, adjusting the pan knob for one of them will adjust the others as well.
4. To mute the track's output, turn off the Track Activator switch. With multiple tracks selected, toggling one of their Track Activators will toggle the others as well.
5. The Solo switch solos the track by muting all other tracks, but can also be used for **cueing**. With multiple tracks selected, pressing any of their Solo switches will solo all of them. Otherwise, tracks can only be soloed one at a time unless the the **Ctrl** (PC) / **⌘** (Mac) modifier is held down or the Exclusive Solo option in the Record/Warp/Launch Preferences is deactivated.
6. If the Arm Recording button is on, the track is **record-enabled**. With multiple tracks selected, pressing any of their Arm switches will arm all of them. Otherwise, tracks can only be armed one at a time unless the the **Ctrl** (PC) / **⌘** (Mac) modifier is held down or the Exclusive Arm option in the Record/Warp/Launch Preferences is deactivated. With Exclusive Arm enabled, inserting an instrument into a new or empty MIDI track will automatically arm the track.

14.1.1 Session Mixer Features

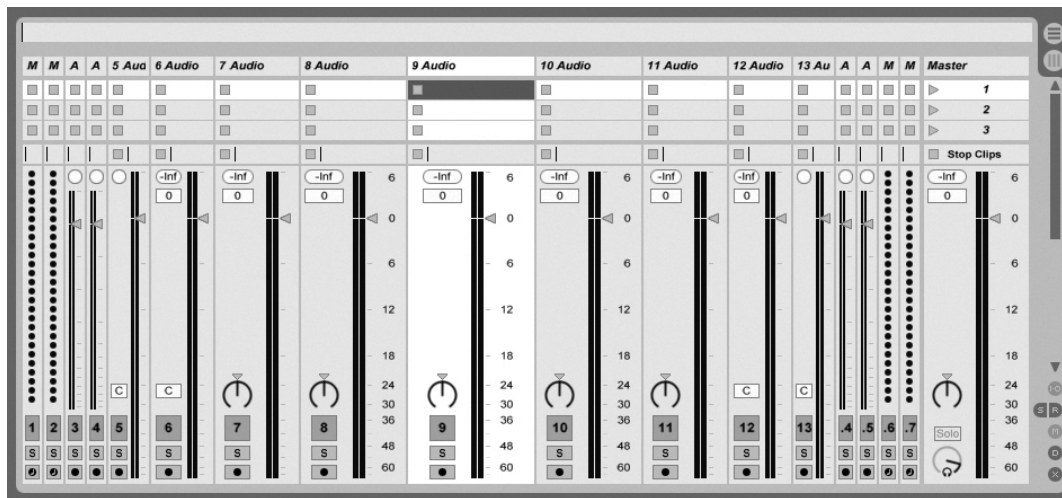

The Session Mixer's Possibilities.

The Mixer section of the Session Mixer has several additional features that are not visible by default. The mixer is resizable, and dragging upwards on the top of the mixer will extend the height of the track meters, adding tick marks, a numeric volume field and resettable peak level indicators. Increasing a track's width in this state will add a decibel scale alongside the meter's tick marks.

These enhancements are tailored for use in traditional mixing settings, but are available anytime the Mixer section is displayed.

Because of the enormous headroom of Live's 32-bit floating point audio engine, Live's meters can be driven far "into the red" without causing the signals to clip. The only time that signals over 0 dB will be problematic is when routing to or from *physical inputs and outputs*, like those of your sound card, or when saving audio to a file.

Nevertheless, Live provides this optional visual feedback for signals that travel beyond 0 dB in any track.

14.2 Audio and MIDI Tracks

Audio and MIDI tracks in Live are for hosting and playing clips, as explained [earlier](#).

You can add new audio and MIDI tracks to your Live Set's mixer at any time using the appropriate Create menu commands.

Tracks can also be created by double-clicking or pressing **Return** on files in the Browser to load them, or by dragging objects from the Browser into the space to the right of Session View tracks or below Arrangement View tracks. Devices or files loaded into Live in this manner will create tracks of the appropriate type (e.g., a MIDI track will be created if a MIDI file or effect is dragged in).

A track is represented by its *track title bar*. You can click on a track title bar to select the track and then execute an Edit menu command on the track. One such command is Rename. One can quickly rename a series of tracks by executing this command (or the Rename shortcut **Ctrl** **R** (PC) / **⌘** **R** (Mac)) and then using the Tab key to move from title bar to title bar. When a # symbol precedes a name, the track will get a number that updates automatically when the track is moved. Adding additional # symbols will prepend the track number with additional zeros. You can also enter your own [info text](#) for a track via the Edit Info Text command in the Edit menu or in the tracks's **⌘** (PC) / **Ctrl** **⌘** (Mac) context menu.

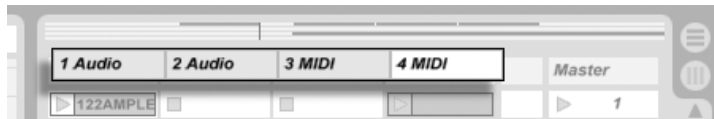

Tracks are Represented by Track Title Bars.

You can drag tracks by their title bars to rearrange them, or click and drag on their edges to change their width (in the Session View) or height (in the Arrangement View).

Multiple adjacent or nonadjacent tracks can be selected at once by **⌘**-clicking or **Ctrl**-clicking, respectively. If you drag a selection of nonadjacent tracks, they will be collapsed together when dropped. To move nonadjacent tracks without collapsing, use **Ctrl** + arrow keys instead of the mouse.

When multiple tracks are selected, adjusting one of their mixer controls will adjust the same control for the other tracks. If the tracks in the multi-selection have differing values for any

particular knob or slider parameter (volume, for example), this difference will be maintained as you adjust the parameter.

If you drag a track's title bar to the Browser it will be saved as a new Set. If a track contains audio clips, Live will manage the copying of the referenced sampled into this new location based on the selection in the **Collect Samples on Export** chooser. You can then type in a name for the newly created Set or confirm the one suggested by Live with **Return**.

Tracks are deleted using the Edit menu's Delete command.

14.3 Group Tracks

You can combine any number of “normal” audio or MIDI tracks into a special kind of summing container called a Group Track. To create a Group Track, select the tracks to include and execute the Edit menu's Group Tracks command.

Group Tracks cannot contain clips, but they are similar to audio tracks in that they have mixer controls and can **host audio effects**. Group Tracks provide a quick way to create submixes, and also offer the ability to fold and unfold their contained clip tracks via the **▶** button in the title bar. This can help you to organize large Sets by hiding away tracks that you don't need to see.

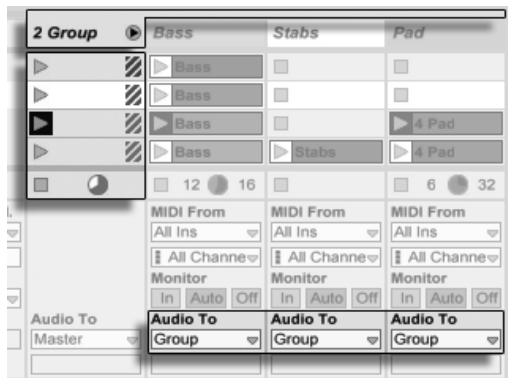

An Unfolded Group Track Visualized in Session View...

When tracks are placed into a group, their Audio To **routing choosers** are automatically assigned to “Group” unless they already had a custom routing (i.e. to a destination other

than “Master.”) You can also use a Group Track purely as a “folder” track by rerouting the outputs of the contained tracks to some other destination.

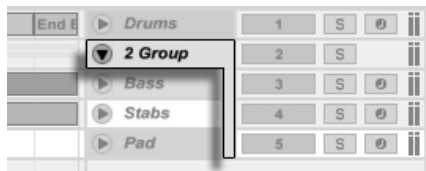

...and in Arrangement View.

Once a Group Track has been created, tracks can be dragged into or out of the group. Deleting a Group Track deletes all of its contents, but a group can be dissolved back into individual tracks by executing the Edit Menu’s Ungroup Tracks command.

Group Tracks in Arrangement View show an overview of the clips in the contained tracks. In Session View, slots in Group Tracks have launch and stop buttons whenever at least one clip is available in a given scene. Launching or stopping this button has the same effect as launching or stopping all contained clips. Likewise, selecting a Group Slot serves as a shortcut for selecting all of the contained clips.

14.4 Return Tracks and the Master Track

In addition to Group Tracks and tracks that play clips, a Live Set has a *Master track* and up to twelve *return tracks*; these cannot play clips, but allow for more flexible signal processing and routing.

The return tracks and the Master track occupy the right-hand side of the Session mixer view and the bottom end of the Arrangement View.

Note that you can hide and show the return tracks using the *Returns* command in the View menu.



Like the “normal” clip tracks, the returns and the Master can **host any number of effects**. However, whereas a clip track’s effect processes only the audio within that track, return tracks can process audio sent to them from numerous tracks.

For example, suppose you want to create rhythmic echoes with a delay effect. If you drag the effect into a clip track, only clips playing in this track will be echoed. Placing this effect

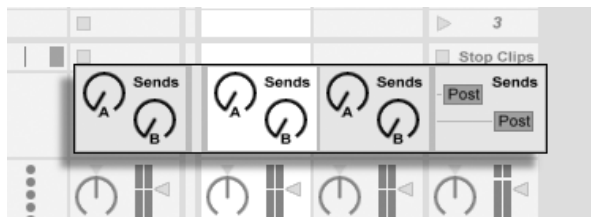
in a return track lets it receive audio from any number of tracks and add echoes to them.



The Send Controls and Pre/Post Toggle.

A clip or group track's Send control regulates how much of the track's output feeds the associated return track's input. What's more, even the return track's own output can be routed to its input, allowing you to create *feedback*. Because runaway feedback can boost the level dramatically and unexpectedly, the Send controls in Return tracks are disabled by default. To enable them,  (PC) /  (Mac) on a Return track's Send knob and select Enable Send or Enable All Sends.

Every return track has a Pre/Post toggle that determines if the signal a clip track sends to it is tapped before or after the mixer stage (i.e., the pan, volume and track-active controls). The "Pre" setting allows you to create an auxiliary mix that is processed in the return track, independently of the main mix. As the return track can be [routed to a separate output](#), this can be used to set up a separate monitor mix for an individual musician in a band.

The Master track is the default destination for the signals from all other tracks. Drag effects here to process the mixed signal before it goes to the master output. Effects in the Master track usually provide *mastering*-related functions, such as compression and/or EQ.

You can create multiple return tracks using the Create menu's Insert Return Track command, but by definition, there is only one Master track.

14.5 Using Live's Crossfader

Live includes a crossfader that can create smooth transitions between clips playing on different tracks. Live's crossfader works like a typical DJ-mixer crossfader, except that it allows crossfading not only two, but any number of tracks – including the returns.

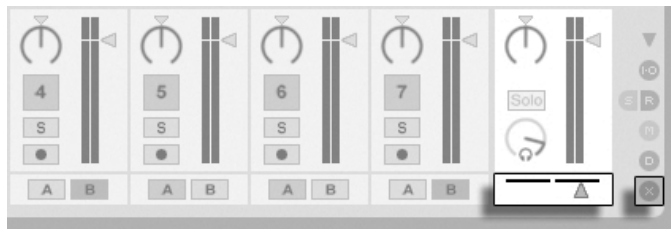

The Crossfader and Selector.

The crossfader is accessed via the Session View's mixer selectors. It features seven different crossfade curves so that you can choose the one that fits your style the best. To change the curve, (PC) / (Mac) on the crossfader, then select an entry from the context menu.

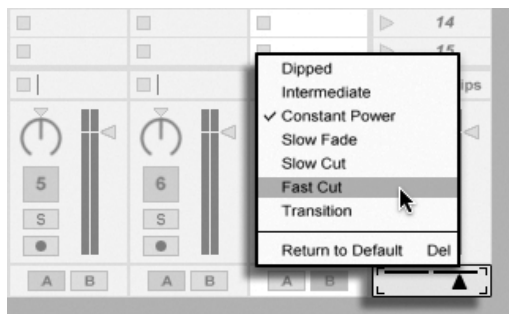

Choose from Seven Crossfader Curves.

The chart below details the power level and response of each crossfader curve.

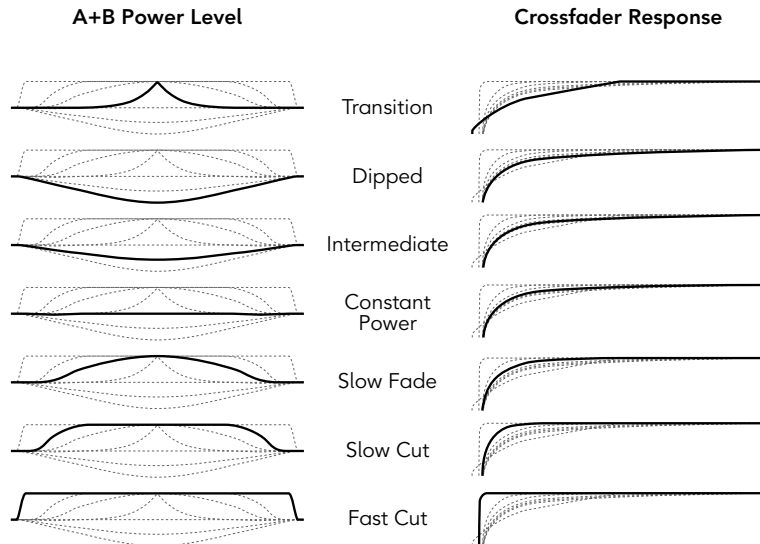

Crossfader Curve Properties.

The crossfader can be **mapped to any continuous MIDI controller (absolute or incremental)**. In addition to the crossfader's central slider, its absolute left and right positions are separately available for MIDI or keyboard mapping. There are two special scenarios for remote control with respect to the crossfader:

- A key mapped to any one of the three assignable crossfader positions (left, center or right) will toggle the crossfader's absolute left and right positions.
- Mapping to two of the three fields allows for a "snapping back" behavior when one of the assigned keys is held down and the other is pressed and released.

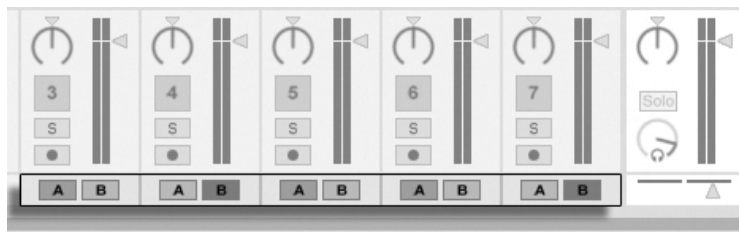

Crossfade Assign Buttons.



Each track has two Crossfade Assign buttons, A and B. The track can have three states with respect to the crossfader:

- If neither Assign button is on, the crossfader does not affect the track at all.
- If A is on, the track will be played unattenuated as long as the crossfader is in the left half of its value range. As the crossfader moves toward the right across the center position, the track fades out. At the crossfader's rightmost position, the track is muted.
- Likewise, if B is on, the track's volume will be affected only as the crossfader moves left across its center position.

It is important to understand that the Crossfade Assign buttons do not affect the signal routing: The crossfader merely influences the signal volume at each track's gain stage. The track can be routed to an individual output bus regardless of its crossfade assignment. In studio parlance, you can think of the crossfader as an on-the-fly VCA group.

As with almost everything in Live, your crossfading maneuvers can be **recorded into the Arrangement** for later in-depth editing. To edit each track's crossfade assignment, please choose "Mixer" from the Envelope Device chooser and "X-Fade Assign" from the Control chooser. The crossfader's automation curve is accessible when "Mixer" is chosen from the Master track's Device chooser and "Crossfade" is selected from its Control chooser.

14.6 Soloing and Cueing

By default, soloing a track simply mutes all other tracks (except in some cases where tracks are **feeding other tracks**). The signal from the soloed tracks is heard through their respective outputs, with the pan setting of each track preserved. Soloing a clip track leaves any return tracks audible, provided that the *Solo in Place* option is enabled in the Solo button's context menu ( (PC) /  (Mac)). Solo in Place can also be set as the default behavior by selecting the entry in the Options menu.

Soloing a return track mutes the main output of all other tracks, but still allows you to hear any signals that arrive at the return via track sends.

Live allows you to replace the standard soloing operation with a *cueing* operation that lets you preview tracks as though you were cueing a record on a DJ mixer. This allows choosing clips and adjusting effects without the audience hearing, before bringing tracks into the mix.

In order to set Live up for cueing, you must be using an audio interface with at least four dedicated outputs (or two dedicated stereo outputs). The respective settings are accessible in the Session View mixer. Make sure you have the Mixer and In/Out options checked in the View menu.

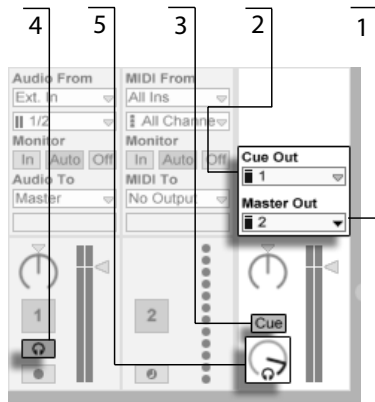

The Cueing-Related Session Mixer Controls.

1. The *Master Out* chooser selects the output on your interface to be used as the main output.
2. The *Cue Out* chooser selects the output on your hardware interface to be used for cueing. This has to be set to an output other than that selected for the Master. If the desired outputs don't show up in these choosers, please check the Audio Preferences.
3. Activate cueing by setting the *Solo/Cue Mode* switch to "Cue."
4. The tracks' *Solo* switches are now replaced by *Cue* switches with headphone icons. When a track's *Cue* switch is pressed, that track's output signal will be heard through the output selected in the *Cue Out* chooser. Note that the *Track Activator* switch on the same track still controls whether or not the track is heard at the *Master* output.
5. The *Cue Volume* control adjusts the volume of the cueing output.

Note that when cueing is set up and activated, the output of audio files that you are previewing in the *Browser* is also heard through the *Cue Out*.

14.7 Track Delays

A Track Delay control is available for every track in Live. The control allows delaying or pre-delaying the output of tracks in milliseconds in order to compensate for human, acoustic, hardware and other real-world delays.

This section of the interface can be shown or hidden using its respective Mixer Section selector.

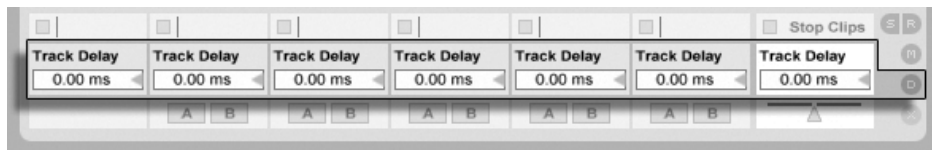

The Track Delay Control and Selector.

We do not recommend changing track delays on stage, as it could result in undesirable clicks or pops in the audio signal. Micro-offsets in Session View clips can be achieved using the [nudge buttons in the Clip View](#), however track delays can be used in the Arrangement View for such offsets.

Note that [delay compensation for plug-ins and Live devices](#) is a separate feature, and is automatic by default. Unusually high Track Delay settings or reported latencies from plug-ins may cause noticeable sluggishness in the software. If you are having latency-related difficulties while recording and playing back instruments, you may want to try turning off device delay compensation, however this is not normally recommended. You may also find that adjusting the individual track delays is useful in these cases. Note that the Track Delay controls are unavailable when device delay compensation is deactivated.

Chapter 15

Recording New Clips

This chapter is about recording new clips from audio and MIDI input signals. Note that this is a different kind of recording than the [capturing of Session clips into the Arrangement](#).

For successful audio recording, please make sure the audio preferences are set up properly. For more on this, please see the built-in program lesson on setting up Audio Preferences. Also, keep in mind that devices such as microphones, guitars and turntables do not operate at line level, meaning that they will need to have their levels boosted before they can be recorded. For these devices, you must therefore use either an audio interface with a preamp, or an external preamp.

15.1 Choosing an Input

A track will record whatever input source is shown in its In/Out section, which appears when the View menu's In/Out option is checked. (In the Arrangement View, unfold and resize the track in order to completely see the In/Out section.)



The Track In/Out Section in the Arrangement (Left) and Session View (Right).

Audio tracks default to recording a stereo signal from the external input pair “1/2.” MIDI tracks default to recording all MIDI that is coming in through the **active external input devices**. The computer keyboard is, by default, activated as a **pseudo-MIDI input device**, allowing you to record MIDI even if no MIDI controller hardware is currently available.

For every track, you can choose an input source other than the default: any mono or stereo external input, a specific MIDI channel from a specific MIDI-in device, audio from ReWire slave programs or a signal coming from another track. The **Routing chapter** describes these options in detail.

15.2 Arming (Record-Enabling) Tracks

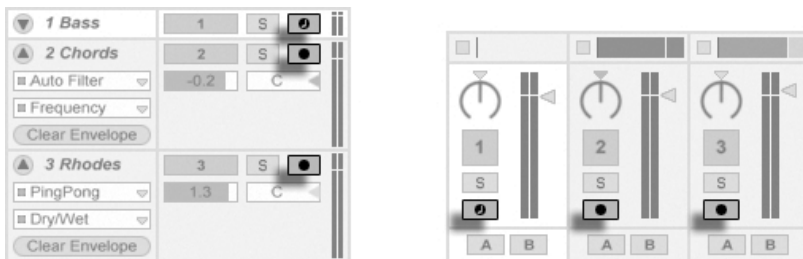

Track Arm Buttons in the Arrangement (Left) and Session (Right) Mixers.

To select a track for recording, click on its Arm button. It doesn’t matter if you click a track’s Arm button in the Session View or in the Arrangement View, since the two **share the same set of tracks**.

By default, armed tracks are monitored, meaning that their input is passed through their device chain and to the output, so that you can listen to what is being recorded. This behavior is called “auto-monitoring” and you can **change it to fit your needs**.

If you are using a natively supported control surface, arming a MIDI track will automatically **lock this control surface** to the instrument in the track.

Clicking one track's Arm button unarms all other tracks unless the **Ctrl** (PC) / **⌘** (Mac) modifier is held. If multiple tracks are selected, clicking one of their Arm buttons will arm the other tracks as well. Arming a track selects the track so you can readily access its **devices in the Track View**.

15.3 Recording

Recording can be done in both the Session and the Arrangement Views. If you want to record onto more than one track simultaneously and/or prefer viewing the recording linearly and in-progress, the Arrangement View may be the better choice. If you want to break your recording seamlessly into multiple clips or record while you are also launching clips in Live, use the Session View.

15.3.1 Recording Into the Arrangement

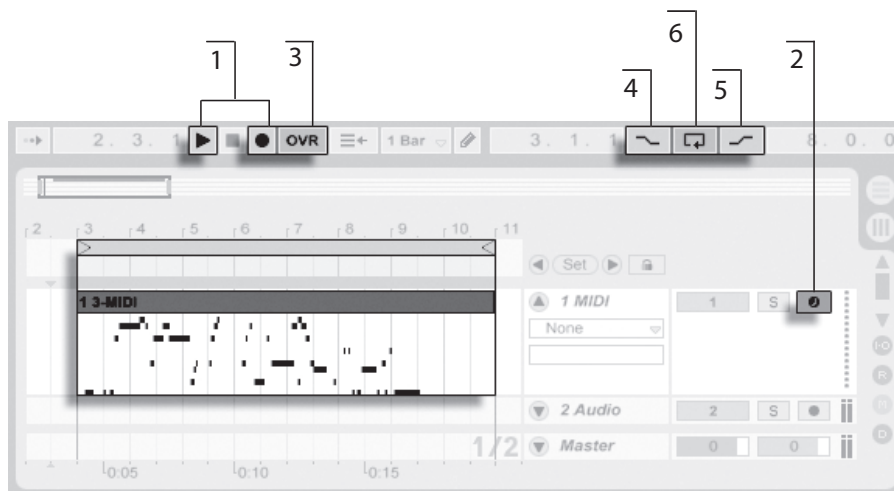

Recording Into the Arrangement.

1. Recording commences when the Control Bar's Record button is activated and the Play button is pressed.
2. Recording creates new clips in all tracks that have their Arm button on.
3. When the Overdub switch is on, the new clips contain a mix of the signal already in the track and the new input signal. The Overdub option only applies to MIDI tracks.
4. To prevent recording prior to a punch-in point, activate the Punch-In switch. This is useful for protecting the parts of a track that you do not want to record over and allows you to set up a pre-roll or "warm-up" time. The punch-in point is identical to the Arrangement Loop's start position.
5. Likewise, to prevent recording after the punch-out point, activate the Punch-Out switch. The punch-out point is identical to the Arrangement Loop's end position.
6. When you are recording into the **Arrangement Loop**, Live retains the audio recorded during each pass.

You can later "unroll" a loop recording, either by repeatedly using the Edit menu's Undo command or graphically in the Clip View: After loop recording, double-click on the new clip. In the Clip View's Sample Display, you can see a long sample containing all audio recorded during the loop-recording process. The Clip View's **loop brace** defines the audio taken in the last pass; moving the markers left lets you audition the audio from previous passes.

15.3.2 Recording Into Session Slots

You can record new clips, on the fly, into any Session slots.

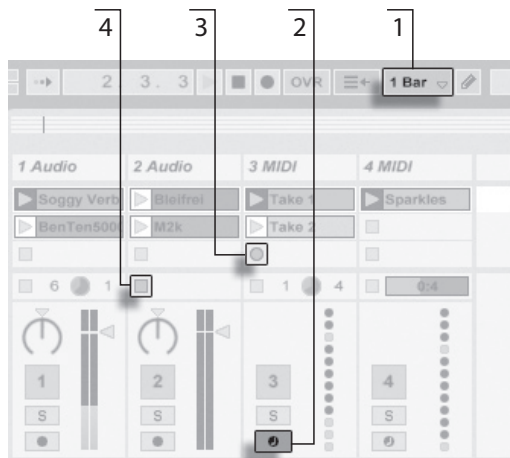

*Recording a New Clip
Into the Session View.*

1. Set the Global Quantization chooser to any value other than “None” to obtain correctly cut clips.
2. Activate the Arm button for the tracks onto which you want to record. Clip Record buttons will appear in the empty slots of the armed tracks.
3. Click on any of the Clip Record buttons to commence recording. A new clip will appear in the slot with a red Clip Launch button that shows it is currently recording. To go from recording immediately into loop playback, press the clip’s Launch button.
4. Alternatively, you can click a Clip Stop button or the Stop button in the Control Bar to stop recording, leaving the new clip silent.

Note that, by default, launching a [Session View scene](#) will not activate recording in empty record-enabled slots belonging to that scene. However, you can use the Start Recording on Scene Launch option from the Record/Warp/Launch Preferences to tell Live that you do want empty scene slots to record under these circumstances.

15.3.3 Overdub Recording MIDI Patterns

Live makes pattern-oriented recording of drums and the like quite easy. Using Live's **Impulse** instrument and the following technique, you can successively build up drum patterns while listening to the result. Or, using an instrument such as **Simpler**, which allows for chromatic playing, you can build up melodies or harmonies, note by note.

1. Set the Global Quantization chooser to one bar.
2. To automatically quantize the notes you are about to record, choose an appropriate value for **Record Quantization**.
3. Double-click any of the Session View slots in the desired MIDI track (the one containing the Impulse or other instrument). A new, empty clip will appear in the slot. The new clip will default to a loop length of one bar, but you can change that by double-clicking the clip and changing its **loop properties**.
4. Arm the track.
5. Launch the clip.
6. The notes you play are added into the looping clip, and you can observe your recording in the Clip View.
7. By default, the Control Bar's Overdub switch is activated, so that you can build your pattern layer by layer. However, if you would like to pause recording for a moment to rehearse, you can deactivate the Overdub switch. The contents of the clip will continue to play, but you can play along without being recorded. When you are ready to record again, simply turn on the Overdub switch.
8. Stop recording by pressing a Clip Stop button or the Stop button in the Control Bar.

Note that holding **Alt** (PC) / **Alt** (Mac) while double-clicking the empty slot to create a new clip will implicitly arm the track and launch the clip.

At any time while overdub recording is going on, you can use the Undo command to remove the last take, or even draw, move or delete notes in the Clip View's Note Editor.

Note that you can also add notes to existing Session clips while the Overdub switch is on.

15.3.4 MIDI Step Recording

The MIDI Editor allows you to record notes with the transport stopped by holding down keys on your controller or **computer MIDI keyboard** and advancing the insert mark according to the grid settings. This process, known as step recording, allows you to enter notes at your own pace, without needing to listen to a metronome or guide track.

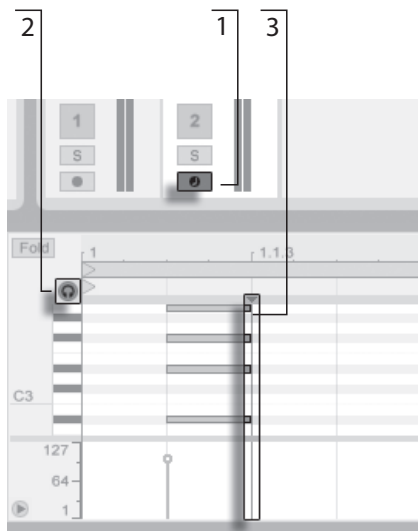

Step Recording in the MIDI Editor.

1. Arm the MIDI track that contains the clip into which you want to record.
2. Enable the Preview switch in the clip's MIDI Editor.
3. Click in the MIDI Editor to place the insert mark at the position where you want to begin recording.

Pressing **⏩** on your computer keyboard will move the insert mark to the right, according to the grid settings. Any notes that are held down as you press **⏩** will be added to the clip. If you continue holding notes as you press **⏩** again, you will extend their duration. To delete notes that you've just recorded, keep them depressed and press **⏪**.

The step recording navigators can also be **MIDI mapped**.

15.4 Recording in Sync

Live keeps the audio and MIDI you have recorded in sync, even when you later decide on a different song tempo. In fact, Live allows you to change the tempo at any time before, after and even during recording. You could, for instance, cheat a bit by turning down the tempo to record a technically difficult part, and pull it up again afterwards.

It is important to *record in sync* to make sure everything will later *play in sync*.



The Metronome Switch.

The easiest way to record in sync is to play along with or to use the built-in metronome, which is activated via its Control Bar switch and will begin ticking when the Play button is pressed or a clip is launched.

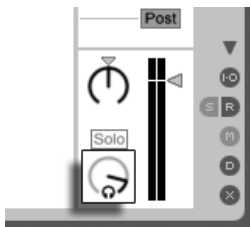

The Preview Volume Knob.

To adjust the metronome volume, use the mixer's Preview Volume knob.

Notice that Live's metrical interpretation of the audio being played can be edited, at any time, using the *Warp Markers*. Warp Markers can be used to fix timing errors and to change the groove or feel of your recordings. Using Warp Markers, you can fix things in your recordings that would otherwise require complicated editing or could not be done at all. Likewise, the metrical interpretation of recorded MIDI can be changed after recording, using the MIDI clip's *Original BPM controls*.

15.5 Recording Quantized MIDI Notes

If you will be recording MIDI, you have the option of automatically quantizing MIDI notes while recording. The Record Quantization chooser in the Edit menu allows selecting the meter subdivisions with which your recorded notes will align. When recording [into Session slots](#) or [into the Arrangement](#), record quantization is an independent step in Live's Undo history. This means that if, for example, you recorded with Record Quantization set to "Eighth Note Triplet Quantization" and then changed your mind, using the Edit menu's Undo command would undo only the quantization and leave your recording otherwise intact.

For Session and Arrangement recording, the Record Quantization setting cannot be changed mid-recording.

When [overdub recording](#) with the Clip View Loop activated, changes to the Record Quantization take effect immediately, and they cannot be separately undone with the Edit menu command.

Recorded MIDI notes can also be quantized post-recording with the Edit menu's Quantize command, as described in the chapter on [editing MIDI](#).

15.6 Recording with Count-in

A count-in for recording can be set in Live's Record/Warp/Launch Preferences. When the Count-In preference is set to any value other than "None," Live will not begin recording until the count-in is complete. The Arrangement Position fields in the Control Bar display the count-in in orange as bars-beats-sixteenths.



The Count-In is Displayed in the Control Bar.

The count-in runs from negative bars-beats-sixteenths (beginning at -2.1.1., for example, with a Count-In setting of 2 bars) up to 1.1.1., at which point recording commences.

Note that count-in recording does not apply when Live is [synced to external MIDI devices](#) or [being used as a ReWire slave](#).

15.7 Setting up File Types

The following Preferences from the Record/Warp/Launch tab are relevant to the sample files that are created by recording:

- The sample file type you would like Live to create can be chosen from the File Type chooser in the Record/Warp/Launch Preferences.
- The bit depth of the sample file you will create by recording can be chosen from the Bit Depth chooser in the Record/Warp/Launch Preferences.

You can save time by setting up reasonable defaults for the clips you are recording in the Record/Warp/Launch Preferences tab. In particular, it is smart to indicate the rough category of sound to be recorded by choosing the appropriate default *Warp Mode*. If you decide later on a different song tempo, the program will automatically maintain **good sound quality**, usually without further adjustment.

15.8 Where are the Recorded Samples?

Recorded samples are stored with the current Set's **Project folder**, under Samples/Recorded. Until the Set is saved, it remains at the location specified by the Temporary Folder preference which is found in the Preferences' File/Folder tab. To make sure Live will not run out of disk space while recording into a new Set, please make sure the Temporary Folder is on a drive/partition with sufficient free space.

15.9 Using Remote Control for Recording

Using **Key Map Mode** and **MIDI Map Mode**, you can operate Live's recording functions without using the mouse.

You can map the Control Bar's Record and transport controls as well as the track Arm buttons. For recording into the Session slots, you can map the individual slots as well as the relative navigation controls to initiate recording remotely; for instance:

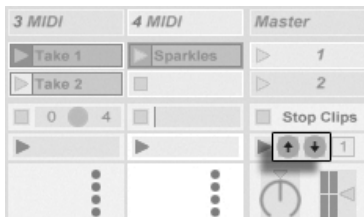

The Scene Up/Down Buttons.

One key is used to jump to the next scene...

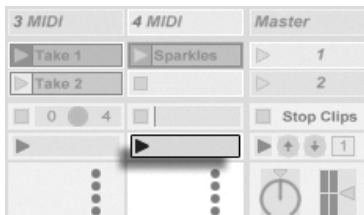

A Track Launch Button.

... and another key to start and end recording in the respective track.

You can also map the **step recording** navigators.

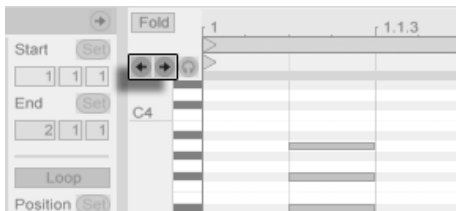

The Step Recording Arrows.

This allows you to, for example, use MIDI foot pedals to move the clip's insert mark, thereby keeping both hands free for playing a keyboard.

Chapter 16

Working with Instruments and Effects



Every track in Live can host a number of devices. These devices can be of three different sorts:

- *MIDI effects* act upon MIDI signals and can only be placed in MIDI tracks.
- *Audio effects* act upon audio signals and can be placed in audio tracks. They can also be placed in MIDI tracks as long as they are “downstream” from an instrument.
- *Instruments* are devices that reside in MIDI tracks, receive MIDI and output audio.

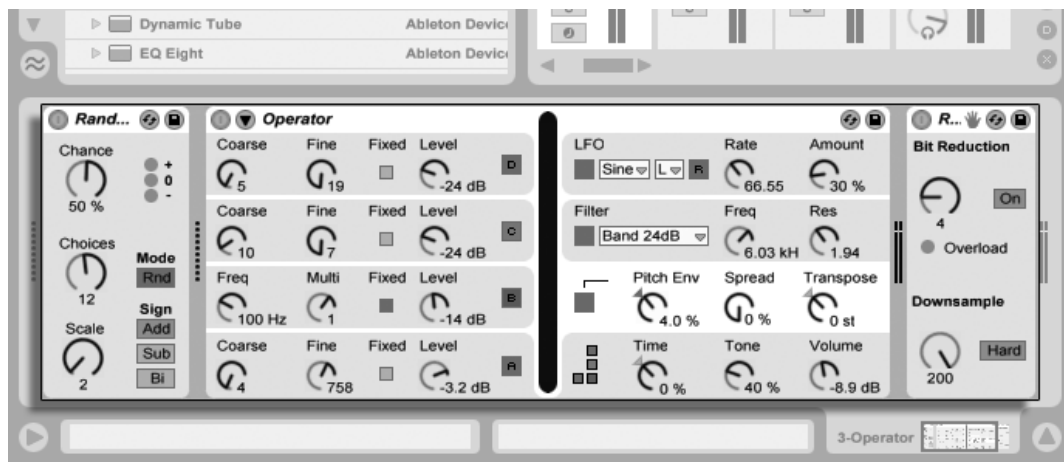
The Track View is where you insert, view and adjust the devices for the selected track. To select a track and open the Track View to access its devices, double-click the track’s name. The Track View appears in the bottom area of the Live screen.



Devices in the Track View.

To save space in the Track View, a device can be collapsed by double-clicking on its title bar or by choosing Fold from its  (PC) /  (Mac) context menu.

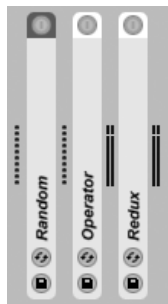

Devices Can Be Folded.

To learn about a particular device and how to operate it, consult the [Live Audio Effect Reference](#), [Live MIDI Effect Reference](#) or the [Live Instrument Reference](#).

To learn about creating and using custom groupings of instruments and effects, check out the [Instrument, Drum and Effect Racks](#) chapter.

Get “hands-on” with devices by assigning their parameters to [MIDI or key remote control](#).

16.1 Using the Live Devices



The Live Device Browser.

Click on the Device Browser selector to access the palette of Live's built-in devices. You will notice that MIDI effects, audio effects and instruments each have their own folders in the Browser.

The easiest way to place a device in a track is to double-click on it in the Browser, which creates a new track to hold the device. Alternatively, select a destination track by clicking within it, then select a device or preset in the Browser and press **Return** to add it to the selected track.

You can also drag devices into tracks or drop areas in the Session and Arrangement Views, or into the Track View. Dragging a sample to the Track View of a MIDI track creates a **Simpler** instrument with this sample loaded.

Note: If you are using an external input signal to feed your Live track using the default settings, the track's **Arm** button in the mixer must be activated in order to hear the input through the devices in your track's device chain. On MIDI tracks, this is normally activated automatically when inserting an instrument.

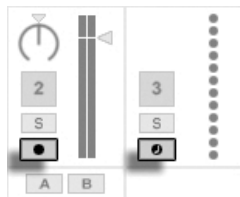

*MIDI and Audio Track
Arm Buttons*

This is how you would play live instruments through effects on a track, for example, or use a MIDI keyboard's input to play a track's instrument. Note that you can easily move from this setup into [recording new clips](#) for further use in Live. If you have alternative monitoring preferences, please see the [Monitoring section](#) to learn how to make these settings.

To add another device to the track, simply drag it there or double-click its name to append it to the device chain. Signals in a device chain always travel from left to right.

You can drop audio effects in at any point in an audio track's device chain, keeping in mind that the order of effects determines the resulting sound. The same is true for a MIDI track's device chain.

If you drop an *instrument* into a MIDI track's device chain, be aware that signals following (to the right of) the instrument are *audio* signals, available only to audio effects. Signals preceding (to the left of) the instrument are *MIDI* signals, available only to MIDI effects. This means that it's possible for a MIDI track's device chain to hold all three types of devices: first MIDI effects, then an instrument, and finally audio effects.

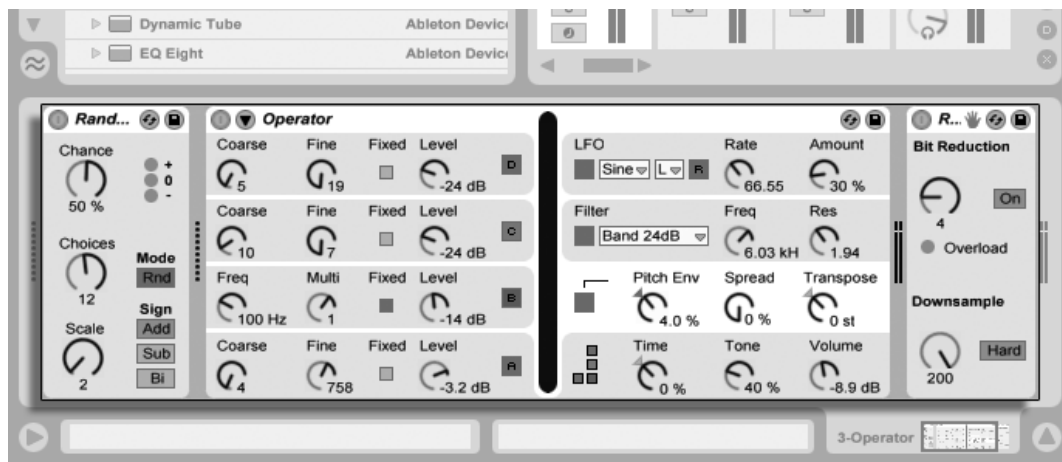

A MIDI Track's Device Chain Can Contain All Three Device Types.

To remove a device from the chain, click on its title bar and press your computer's  or **Delete** key, or select Delete from the Edit menu. To change the order of devices, drag a device by its title bar and drop it next to any of the other devices in the Track View. Devices can be moved to other tracks entirely by dragging them from the Track View into the Session or Arrangement Views.

Edit menu commands such as cut, copy, paste and duplicate can be used on devices. Pasted devices are inserted in front of the selected device. You can paste at the end of a device chain by clicking in the space after the last device, or by using the  key to move the selection there. Generally, devices can be placed, reordered and deleted without interrupting the audio stream.

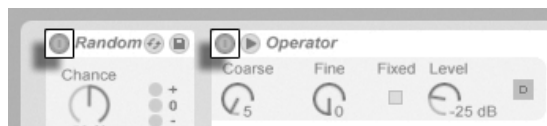

Device Activator Switches.

Devices are turned on and off using their Activator switches. Turning a device off is like temporarily deleting it: The signal remains unprocessed, and the device does not consume CPU cycles. Live devices generally do not load down the CPU unless they are active. For more information, please refer to the [CPU load section](#). The Freeze Track command discussed there is especially helpful when working with CPU-intensive devices.

Devices in Live's tracks have input and output level meters. These meters are helpful in finding problematic devices in the device chain: Low or absent signals will be revealed by the level meters, and relevant device settings can then be adjusted, or the device can be turned off or removed.



The Level Meters Between Devices in a Chain.

Note that no clipping can occur between devices because there is practically unlimited headroom. Clipping can occur when an overly strong signal is sent to a *physical output* or written to a sample file.

Further information about track types in Live can be found in the [Routing and I/O chapter](#), including information on using *return tracks* to distribute the effect of a single device amongst several tracks. After reading about using devices in Live, it might also be interesting to look into [clip envelopes](#), which can modulate individual device parameters on a per-clip basis.

16.1.1 Live Device Presets

Every Live device can store and retrieve their parameter settings as *presets*. Presets for Live instruments and effects are managed through the Device Browser. Each device appears there as a folder that can be opened to reveal its presets.



Presets in the Device Browser.

You can browse and load presets quickly with the computer keyboard:

- Scroll up and down using the **↑** and **↓** keys.
- Close and open device folders using the **←** and **→** keys.
- Press **Return** to load a device or preset.



The Hot-Swap Presets Button.

Clicking a device's *Hot-Swap Presets* button will temporarily link the Browser to a device, calling up its presets in the Device Browser. With the device and Browser linked in this manner, you can quickly browse, load and audition different presets. You can even replace the current device with a new one by simply selecting another device's preset. To load a device's default factory settings, select the parent folder of its presets (i.e., the one with the device's name) from the Device Browser.

The link between the Device Browser and the device will be broken if a different view is selected, or if the Hot-Swap button is pressed again. Preset hot-swapping can also be cancelled with a press of the **Esc** key or by pressing the close button in the Hot-Swap bar at the top of the Browser.

Note that although importing via the Browser is the recommended method, presets can also be dropped directly into Live from the Explorer (Windows)/Finder (Mac).

Saving Presets

You can create and save any number of your own presets in the Device Browser.



The Save Preset Button.

Click the Save Preset button to save a device's current settings (including any custom [info text](#)) as a new preset. You will be redirected to the Browser, where you can press [Return](#) to use Live's suggested name, or you can type one of your own. You can also save presets to specific folders in the Browser (such as your Current Project folder) by dragging from the title bar of the device and dropping into the Browser location of your choice.



For detailed information on what can be done with the Browser, please see the [Managing Files and Sets](#) chapter. For more on how to store project-specific presets, see the [appropriate section](#).

Default Presets

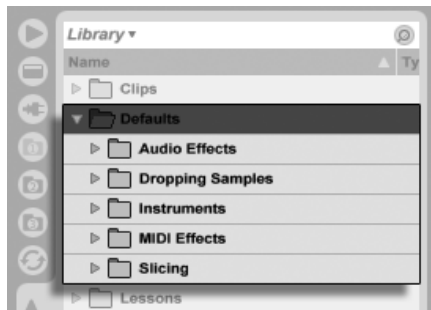
Presets saved to the *Defaults* folders in Live's Library will load in place of Live's generic device settings. There are also Defaults folders that allow you to customize how Live responds to various user actions, such as sample dropping and [slicing](#).



The Default Presets folders in Live's Library.

To save the current settings of a device as a default preset, open the  (PC) / [Ctrl](#)  (Mac) context menu on the device's header and select "Save as Default Preset." This works

for all of Live's instruments, MIDI effects and audio effects (including the various types of **Racks**). If you have already saved a default preset for a particular device, Live will ask you before overwriting it.

To specify how Live behaves when dragging a sample to a Drum Rack or the Track View of a MIDI track:

- Create an empty Simplifier or Sampler
- Adjust the parameters as you like
- Drag the edited device to the "On Drum Rack" or "On Track View" folder, which can be found at Library/Defaults/Dropping Samples

To adjust how Live behaves when slicing an audio file:

- Create an empty Drum Rack
- Add an empty Simplifier or Sampler to the Drum Rack to create a single chain
- Add any additional MIDI or Audio Effects to this chain
- Adjust parameters in any of the devices
- Assign **Macro Controls** to any of the controls in the chain's devices
- Drag the entire Drum Rack to the Library/Defaults/Slicing folder

You can create multiple slicing presets and choose between them in the Slicing Preset chooser in the slicing dialog.

16.2 Using Plug-Ins

The collection of devices that you can use in Live can be extended with *plug-ins*. Live supports Steinberg Media's VST Plug-ins format, as well as the Audio Units (AU) Plug-ins format (Mac OS X only).

Working with VST and Audio Units Plug-ins is very much like working with Live devices. VST and AU instruments can only be placed in Live MIDI tracks and, like Live instruments, they will receive MIDI and output audio signals. Plug-in audio effects can only be placed in audio

tracks or following instruments. Please see the previous section, [Using the Live Devices](#), for details.

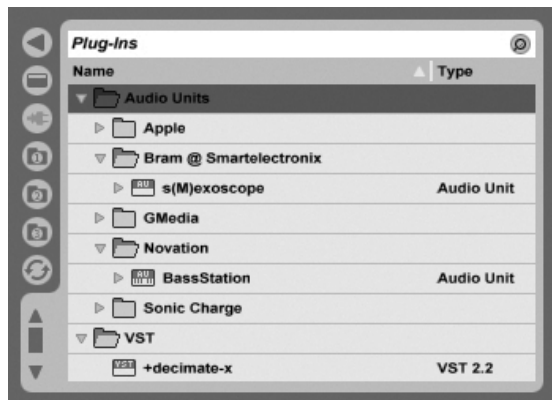

The Plug-In Device Browser.

Audio Units and VST Plug-ins are browsed and imported using the Plug-In Device Browser, which is accessed via its selector. Plug-in instruments can be differentiated from plug-in effects in the Browser, as they appear with a keyboard icon.

The Browser's search functionality is only available for Audio Units Plug-ins, as is loading presets directly from Track View devices via the Hot-Swap button. In some instances, factory presets for Audio Units will only appear in the Browser once the device has been placed in a track and its Hot-Swap button activated.

Note: The first time you start Live, no plug-ins will appear in the Plug-In Device Browser, as you must first “activate” your plug-in sources. Activating your plug-in sources tells Live which plug-ins you want to use and where they are located on your computer. Information on activating (and deactivating) plug-in sources can be found later in this chapter, in the sections on the [VST Plug-in folder](#) and [Audio Units Plug-ins](#).

Note for “Intel® Mac” users: Intel® Mac computers cannot natively run VST or AU plug-ins that have been written for the PowerPC platform. Only plug-ins of type (Universal) or (Intel®) can be used in Live.

If you install/de-install a plug-in while the program is running, Live will not detect your changes or implement them in the Plug-In Device Browser until the next time you start the program. Use the *Rescan* button in the File/Folder Preferences to rescan your plug-ins while

Live is running, so that newly installed devices become immediately available in the Plug-In Device Browser.

You can also rescan if you believe that your plug-in database has somehow become corrupted. Holding down the **[Alt]** (PC) / **[Alt]** (Mac) modifier while pressing Rescan will delete your plug-in database altogether and run a clean scan of your plug-ins.

16.2.1 Plug-Ins in the Track View

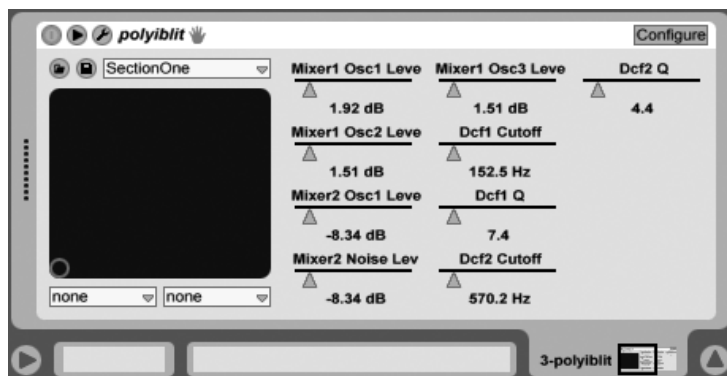

A VST Plug-In in the Track View.

Once a plug-in is dragged from the Browser into a track, it will show up in the Track View. For plug-ins with fewer than 32 modifiable parameters, a Live panel will represent all of the parameters as horizontal sliders. Plug-ins that contain more than 32 parameters will open with an empty panel, which you can then configure to show the parameters you want to access. The plug-in's original interface can be opened in a [separate window](#).

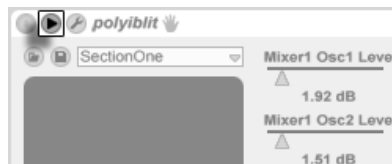

The Plug-In Unfold Button.

You can view or hide the plug-in's parameters by toggling the **[▶]** button in the plug-in's title bar.

The X-Y control field can be used to control two plug-in parameters at once and is therefore especially well-suited for live control. To assign any two plug-in parameters to the Live panel X-Y field, use the drop-down menus directly beneath it.

Showing Plug-In Panels in Separate Windows

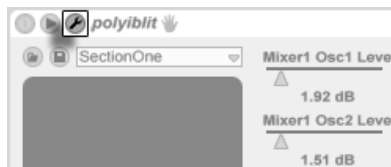

The Plug-In Edit Button.

The Plug-In Edit button opens a floating window that shows the original VST or Audio Units Plug-in panel. Changing parameters on the floating window has the same effect as changing them in the Live panel, and vice versa.

There are a few important Plug-In Preference settings for working with plug-in edit windows:

- If activated, the *Auto-Open Plug-In Windows* Preference assures that plug-in edit windows open automatically when plug-ins are loaded into tracks from the Browser.
- If the *Multiple Plug-In Windows* option in the Plug-In Preferences is activated, you can open any number of plug-in windows at once. Even with this option off, you can hold down the **Ctrl** (PC) / **⌘** (Mac) modifier when opening a new plug-in window to keep the previous window(s) from closing.
- Using the *Auto-Hide Plug-In Windows* preference, you can choose to have Live display only those plug-in windows belonging to the track that is currently selected.

You can use the View menu's Show/Hide Plug-In Windows command or the **Ctrl** **Alt** **P** (PC) / **⌘** **Alt** **P** (Mac) shortcut to hide and show your open plug-in windows. Notice that the name of the track to which the plug-in belongs is displayed in the title bar of the plug-in editor window.

Plug-In Configure Mode

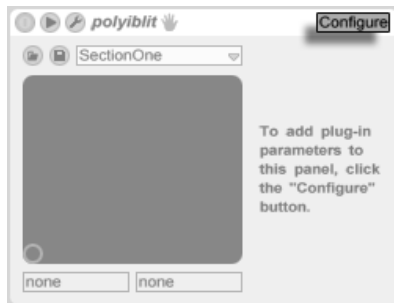

The Configure Button.

Configure Mode allows you to customize Live's panel to show only the plug-in parameters that you need to access. To do this:

- Enter Configure Mode by pressing the "Configure" button in the device's header.
- Click on a parameter in the plug-in edit window to add it to Live's panel. (For some plug-ins, it may be necessary to actually change the parameter's value. Additionally, certain plug-ins do not "publish" all of their parameters to Live. These parameters cannot be added to Live's panel.)

While in Configure Mode, parameters in Live's panel can be reordered or moved by dragging and dropping them to new locations. Parameters can be deleted by pressing the **Delete** key. If you try to delete a parameter that has existing **automation data**, **clip envelopes**, or **MIDI, key** or **Macro** mappings, Live will warn you before proceeding.

The parameters that you assign are unique for each instance of a given plug-in in your Set, and are saved with the Set.

Certain plug-ins do not have their own windows, and instead only show their parameters in Live's panel. For these plug-ins, it is not possible to delete parameters when in Configure Mode (although they can still be moved and reordered).

There are several ways to add plug-in parameters to Live's panel without entering Configure Mode:

- Adjusting a parameter in the plug-in's floating window creates temporary entries for that parameter in the clip envelope and automation choosers, as well as the choosers

in the panel's X-Y field. These entries are removed when you adjust another parameter. To make the entry permanent (thus adding it to Live's panel), either edit the parameter's automation or clip envelope, select another parameter in the automation or clip envelope choosers or select the temporary parameter in one of the X-Y field's choosers.

- When a parameter is changed on a plug-in's edit window during recording, automation data is recorded automatically. When recording is stopped, the automated parameters are automatically added to Live's panels for any plug-ins that were adjusted.
- When in MIDI, key or Macro mapping mode, adjusting any parameter in the plug-in's window will create it in Live's panel. The new panel entry will be automatically selected, allowing you to map it immediately.

Once a plug-in is placed in a track and you have (optionally) configured its parameters in Live's panel, you can use it just like a Live device:

- You can map MIDI controller messages to all of the parameters in Live's panel.
- You can drag or copy the device to different locations in the device chain or to other tracks, according to the rules of audio effects and instruments.
- You can modulate its continuous parameters with clip envelopes.
- You can use the multiple I/O features of some plug-ins by assigning them as sources or targets in the routing setup of tracks. See the [Routing and I/O chapter](#) for details.
- You can create custom [info text](#) for the plug-in.

Macintosh only: The floating editor windows of some VST Plug-ins do not receive computer key strokes. This is generally an implementation error in the plug-in itself. If it is necessary to type into a plug-in window, for instance for entering a serial number or unlock code, hold down  while clicking the Plug-In Edit button. The editor window will then appear as a "normal" application window, rather than as a floating window, and receive your typing. Note that this functionality is intended only as a workaround for the limitations of such plug-ins. We recommend closing the window after you have finished typing, then reopening it normally before working with the plug-in parameters.

16.2.2 Plug-In Performance Options

The CPU Preferences contain a Plug-In Buffer Size setting for balancing plug-in latency and performance. Here you can set the number of samples processed at any one time by the plug-in. Higher settings may result in a noticeable performance increase but will also result in higher latencies.

With the “As Audio Buffer” setting selected, the plug-in will calculate the exact number of samples per millisecond as the computer’s sound card. This setting usually means that very few dropouts or performance problems will occur, especially with DSP cards.

The size of the computer’s sound card buffer (i.e., the number of samples it calculates per millisecond) can be set using the Buffer Size setting in the Audio Preferences.

16.3 VST Plug-Ins

16.3.1 The VST Plug-In Folder

When you start Live for the first time, you will need to activate your VST Plug-in sources before working with VST Plug-ins. Depending on your computer platform, you may also have to tell Live about the location of the VST Plug-in folder containing the devices you want to use. In order to set up your VST sources, press the Activate button in the Plug-In Device Browser, or open the File/Folder Preferences by pressing **Ctrl** + **F** (PC) / **⌘** + **F** (Mac). There you will find the Plug-In Sources section.



Setting up VST Plug-In Sources for Windows.

For Windows, proceed as follows:

1. Use the VST Plug-In Custom Folder entry to tell Live about the location of your VST Plug-ins: Click the *Browse* button to open a folder-search dialog for locating and selecting the appropriate folder.

2. Once you have selected a VST Custom Folder and Live has scanned it, the path will be displayed. Note that, on Windows, Live may have found a path in the registry without the need for browsing.
3. Make sure that the Use VST Plug-In Custom Folder option is set to “On,” so that your selected folder is an active source for VST Plug-ins in Live. Note that you can choose not to use your VST Plug-ins in Live by turning off the Use VST Plug-In Custom Folder option.



Setting up VST Plug-In Sources for Mac OS X.

Set up your VST Plug-ins under Mac OS X by doing the following:

1. Your VST Plug-ins will normally be installed in the following folder in your home and local directories: /Library/Audio/Plug-Ins/VST. You can turn Live’s use of these plug-ins on or off with the Use VST Plug-ins in System Folders option.
2. You may have an alternative folder in which you store your VST Plug-ins (perhaps those that you use only with Live). You can use VST Plug-ins in this folder in addition to, or instead of, those in the System folders. To tell Live about the location of this folder, click the *Browse* button next to the VST Plug-In Custom Folder entry to open a folder-search dialog for locating and selecting the appropriate folder.
3. Note that you can turn off your VST Plug-ins in this folder using the Use VST Plug-In Custom folder option.

Once you have configured your Plug-In Preferences, the Plug-In Device Browser will display all plug-ins it finds in the selected VST Plug-in folder(s) as well as any sub-folders.

It is also possible to use VST Plug-ins stored in different folders on your computer. To do this, create a Mac OS or Windows *alias* of the folder where additional VST Plug-ins are stored, and then place the alias in the VST Plug-In Custom folder (or in the VST Plug-In

System folder on Mac OS X) selected in Live's File/Folder Preferences. The alias can point to a different partition or hard drive on your computer. Live will scan the set VST Plug-in folder as well as any alias folders contained therein.

Some VST Plug-ins contain errors or are incompatible with Live. During the scanning process, these may cause the program to crash. When you re-launching Live, a dialog will appear to inform you about which plug-in caused the problem. Depending on what Live detects about the plug-in, you may be given the choice between performing another scan or making the problematic plug-in unavailable. If you choose to rescan and they crash the program a second time, Live will automatically make them unavailable, meaning that they will not appear in the Plug-In Device Browser and will not be rescanned again until they are reinstalled.

16.3.2 VST Programs and Banks

Every VST Plug-in instance "owns" a *bank* of *programs*. A program is meant to contain one complete set of values for the plug-in's controls.

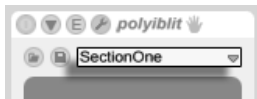

The VST Plug-In Program Chooser.

To select a program from the plug-in's bank, use the chooser below the title bar. The number of programs per bank is fixed. You are always working "in" the currently selected program, that is, all changes to the plug-in's controls become part of the selected program.

Note that VST programs are different from [Live device presets](#): Whereas the presets for a Live device are shared among all instances and Live Sets, the VST programs "belong" to this specific instance of the VST Plug-in.



Renaming a VST Plug-In Program.

To rename the current program, select the VST program chooser and execute the Edit menu's Rename Plug-In Preset command. Then type in a new program name and confirm by pressing **Return**.



The VST Program/Bank Load Button (Left) and Save Button (Right).

VST programs and banks can be imported from files. Clicking the VST Program Load button brings up a standard file-open dialog for locating the desired file.

Windows only: Please select from the File Type menu whether you want to locate VST Device Program files or VST Device Bank files.

To save the currently selected program as a file, click the VST Program/Bank Save button to bring up a standard file-save dialog; select “VST Device Program” from the Format menu (Macintosh)/from the File Type menu (Windows); select a folder and name. For saving the entire bank as a file, proceed likewise but choose “VST Device Bank” as a file type/format.

16.4 Audio Units Plug-Ins

Audio Units Plug-ins are only available in Mac OS X. In most respects, they operate just like [VST Plug-ins](#).

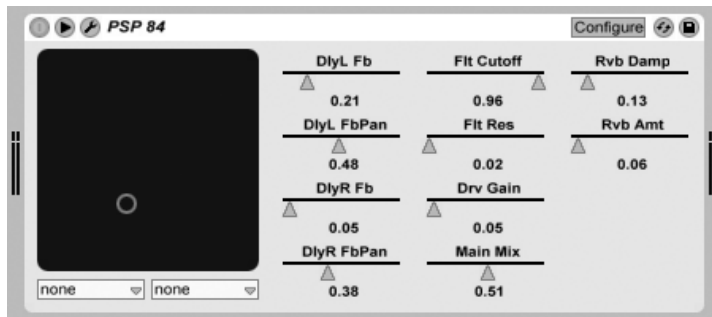

An Audio Units Plug-In.

The first time you open Live, Audio Units Plug-ins will not appear in the Plug-In Device Browser. In order to activate your Audio Units as a plug-in source, please press the Activate button in the Plug-In Device Browser, or go to the File/Folder Preferences by pressing **Ctrl** + **,** (PC) / **⌘** + **,** (Mac). There you will find the Plug-In Sources section. Turning

on the Use Audio Units option activates Audio Units Plug-ins so that they appear in Live's Plug-In Device Browser.

Note that you can always turn this option off later if you decide not to use Audio Units.

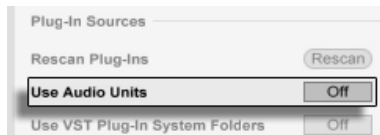

Activating Audio Units Plug-Ins.

Audio Units Plug-ins sometimes have a feature that allows choosing between different modes for the device. You might be able to choose, for example, between different levels of quality in the rendering of a reverb. Choosers for these device modes can only be accessed through the original plug-in panel, which is opened using the Plug-In Edit button.



Opening an Audio Units Plug-In Window.

Audio Units have presets that function just like those for the [Live effects](#). However, some AU presets cannot be dragged to different locations in the Browser, as they are read-only.

Audio Units presets have an `.aupreset` extension and are stored in the following directory according to their manufacturer's name:

```
[Home]/Library/Audio/Presets/[Manufacturer Name]/[Plug-in Name]
```

16.5 Device Delay Compensation

Live automatically compensates for delays caused by Live and plug-in instruments and effects, including those on the return tracks. These delays can arise from the time taken by devices to process an input signal and output a result. The compensation algorithm keeps all of Live's tracks in sync, regardless of what their devices are doing, while minimizing delay between the player's actions and the audible result.

Device delay compensation is on by default and does not normally have to be adjusted in any way. However, Live Sets that were created with Live 4 or earlier will open without device delay compensation. To manually turn latency compensation on (or off), use the Delay Compensation option in the Options menu.

Unusually high **individual track delays** or reported latencies from plug-ins may cause noticeable sluggishness in the software. If you are having latency-related difficulties while recording and playing back instruments, you may want to try turning off device delay compensation, however this is not normally recommended. You may also find that adjusting the individual track delays is useful in these cases.

Note that device delay compensation can, depending on the number of tracks and devices in use, increase the CPU load.

Chapter 17

Instrument, Drum and Effect Racks

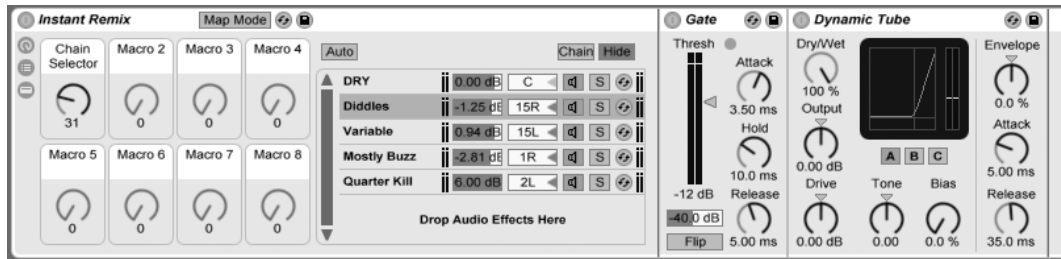

An Audio Effect Rack.

A Rack is a flexible tool for working with effects, plug-ins and instruments in a track's device chain. Racks can be used to build complex processors, dynamic performance instruments, stacked synthesizers and more. Yet they also streamline your device chain by bringing together your most essential controls. While Racks excel at handling multiple devices, they can extend the abilities of even a single device by defining new control relationships between its parameters.

Racks greatly expand upon the concept of device groups introduced in Live 5. The device groups of any Live Sets imported from Live 5 are automatically converted to Racks by Live 8. *Note that these Live Sets, once saved, can no longer be opened in older versions of Live.*

17.1 An Overview of Racks

17.1.1 Signal Flow and Parallel Device Chains

In any of Live's tracks, devices are connected serially in a *device chain*, passing their signals from one device to the next, left to right. By default, the Track View displays only a single chain, but there is actually no limit to the number of chains contained within a track.

Racks allow (among other things) additional device chains to be added to any track. When a track has multiple chains, they operate in *parallel*: In Instrument and Effect Racks, each chain receives the same input signal at the same time, but then processes its signal *serially* through its own devices. The output of each of the parallel chains is mixed together, producing the Rack's output.

Drum Racks also allow multiple parallel chains to be used simultaneously, but their chains process input somewhat differently: Rather than receiving the same input signals, each Drum Rack chain receives input from only a single assigned MIDI note.

The entire contents of any Rack can be thought of as a single device. This means that adding a new Rack at any point in a device chain is no different than adding any other device, and Racks can contain any number of other Racks. If more devices are placed after a Rack in a track's device chain, the Rack's output is passed on to them, as usual.

17.1.2 Macro Controls

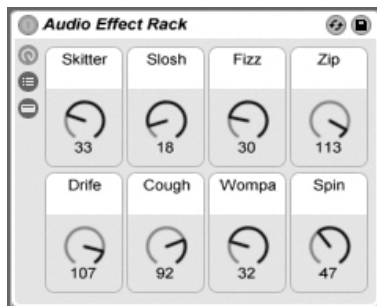

The Macro Controls.

One unique property of Racks are their *Macro Controls*.

The Macro Controls are a bank of eight knobs, each capable of addressing any number of parameters from any devices in a Rack. How you use them is up to you – whether it be for convenience, by making an important device parameter more accessible; for defining exotic, multi-parameter morphs of rhythm and timbre; or for constructing a mega-synth, and hiding it away behind a single customized interface. See [Using the Macro Controls](#) for a detailed explanation of how to do this.



For the greatest degree of expression, try [MIDI-mapping](#) the Macro Controls to an external control surface.

17.2 Creating Racks

Four Rack variants cover the range of Live's devices: Instrument Racks, Drum Racks, Audio Effect Racks and MIDI Effect Racks. Just as with track types, each kind of Rack has rules regarding the devices it contains:

- *MIDI Effect Racks* contain only MIDI effects, and can only be placed in MIDI tracks.
- *Audio Effect Racks* contain only audio effects, and can be placed in audio tracks. They can also be placed in MIDI tracks, as long as they are “downstream” from an instrument.
- *Instrument Racks* contain instruments, but can additionally contain both MIDI and audio effects. In this case, all MIDI effects have to be at the beginning of the Instrument Rack's device chain, followed by an instrument, and then any audio effects.
- *Drum Racks* are similar to Instrument Racks; they can contain instruments as well as MIDI and audio effects and their devices must be ordered according to the same signal flow rules. Drum Racks can also contain up to six *return chains* of audio effects, with independent send levels for each chain in the main Rack.

There are different ways to create Racks. A new, empty Rack can be created by dragging a generic Rack preset (“*Audio Effect Rack*,” for example) from the Device Browser into a track. Devices can then be dropped directly into the Rack's Chain List or Devices view, which are introduced in the [next section](#).

If a track already has one or more devices that you would like to group into a Rack, then simply select the title bars of those devices in the Track View, and  (PC) /  (Mac)

on one of the title bars to reveal the *Group* and *Group to Drum Rack* commands in the context menu. Note that if you repeat one of these commands again on the same device, you will create a Rack within a Rack. You can also group multiple *chains* within a Rack using the same procedure. Doing this also creates a Rack within a Rack. In the Track View, the contents of Racks are always contained between end brackets: Just as with punctuation or in mathematics, a Rack within a Rack will have a pair of brackets within a pair of brackets.

To ungroup devices, dismantling their Racks, select the *Rack's* title bar, and then use the Edit menu or the context menu to access the *Ungroup* command.

17.3 Looking at Racks

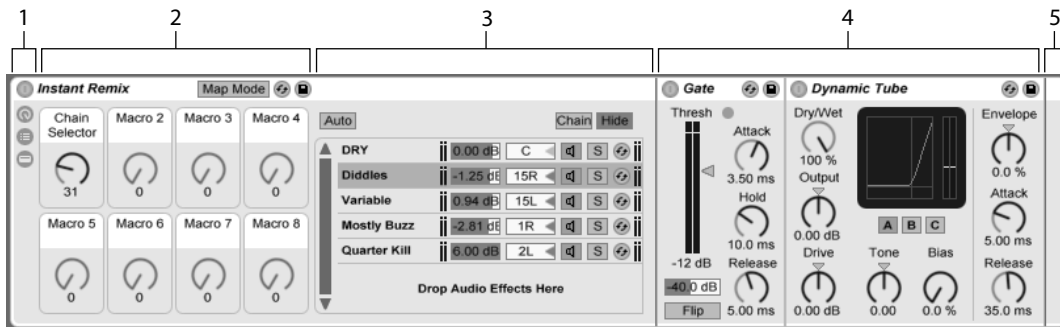

Components of an Effect Rack.

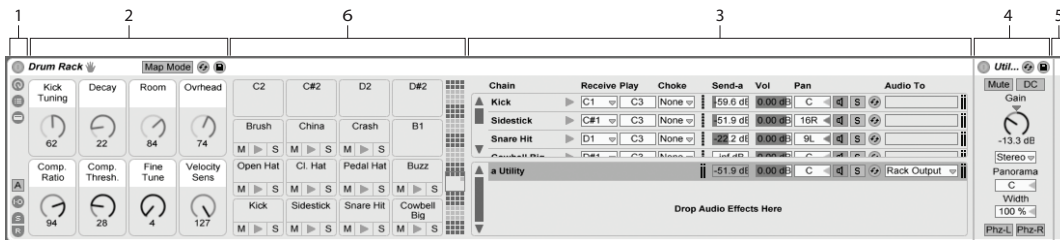

Components of a Drum Rack.

1. Racks have distinct views that can be shown or hidden as needed. Therefore, every Rack has a *view column* on its far left side that holds the corresponding view selectors. The actual view selectors available differ depending on whether

an Instrument, Drum or Effect Rack is being used.



2. *Macro Controls*



3. *Chain List.* In Drum Racks, this view can include both drum chains and return chains.



4. *Devices*

5. Racks are also identifiable by their round corners, which bracket and enclose their content. When the Devices view is shown, the *end bracket* visually detaches itself to keep the Rack hierarchy clear.

6. *Pad View.* This is unique to Drum Racks.

To move, copy or delete an entire Rack at once, simply select it by its title bar (as opposed to the title bars of any devices that it contains). When selected, a Rack can also be renamed by using the Edit menu's *Rename* command. You can also enter your own *info text* for a Rack via the Edit Info Text command in the Edit menu or in the Racks's  (PC) /  (Mac) context menu.

When all of a Rack's views are hidden, its title bar will fold into the view column, making the entire Rack as slim as possible. This has the same effect as choosing *Fold* from the  (PC) /  (Mac) context menu or double-clicking on the Rack's title bar.

If you would like to locate a particular device in a Rack without searching manually through its entire contents, you will appreciate this navigation shortcut:  (PC) /  (Mac) on the Track View selector, and a hierarchical list of all devices in the track's device chain will appear. Simply select an entry from the list, and Live will select that device and move it into view for you.

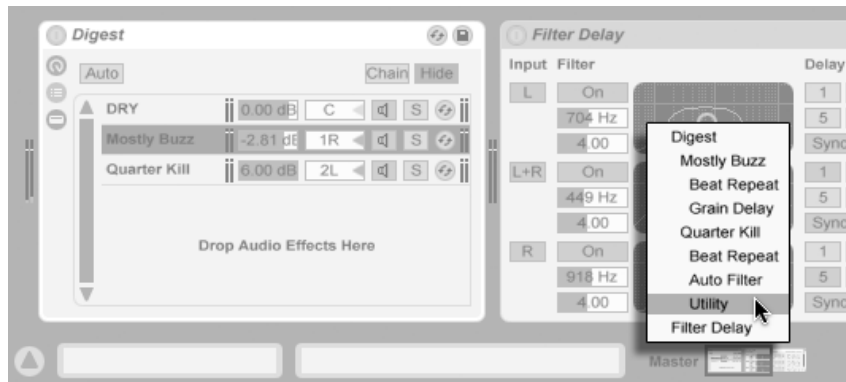

*Navigate Racks Quickly
Via a Context Menu.*

17.4 Chain List

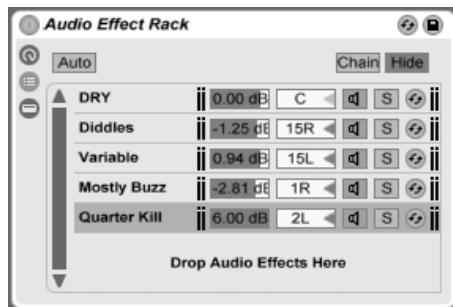

*The Chain List in an
Audio Effect Rack.*

As signals enter a Rack, they are first greeted by the Chain List. We will therefore also choose this point for our own introduction.

The Chain List represents the branching point for incoming signals: Each parallel device chain starts here, as an entry in the list. Below the list is a drop area, where new chains can be added by dragging and dropping presets, devices, or even pre-existing chains.

Note: Racks, chains and devices can be freely dragged into and out of other Racks, and even between tracks. Selecting a chain, then dragging and hovering over another Session

or Arrangement View track will give that track focus; its Track View will open, allowing you to drop your chain into place.

Since the Track View can show only one device chain at a time, the Chain List also serves as a navigational aid: The list selection determines what will be shown in the adjacent Devices view (when enabled). Try using your computer keyboard's \downarrow and \uparrow keys to change the selection in the Chain List, and you'll find that you can quickly flip through the contents of a Rack.

The Chain List also supports multi-selection of chains, for convenient copying, organizing and regrouping. In this case, the Devices view will indicate how many chains are currently selected.

Each chain has its own Chain Activator, as well as Solo and **Hot-Swap** buttons. Chains in Instrument, Drum and Audio Effect Racks also have their own volume and pan sliders, and Drum Rack chains have additional send level and MIDI assignment controls. Like Live Clips, entire chains can be saved and recalled as presets in the Device Browser. You can give a chain a descriptive name by selecting it, then choosing the Edit menu's Rename command. You can also enter your own **info text** for a chain via the Edit Info Text command in the Edit menu or in the chain's ⌘ (PC) / ⌘ (Mac) context menu. The context menu also contains a color palette where you can choose a custom chain color.

17.4.1 Auto Select

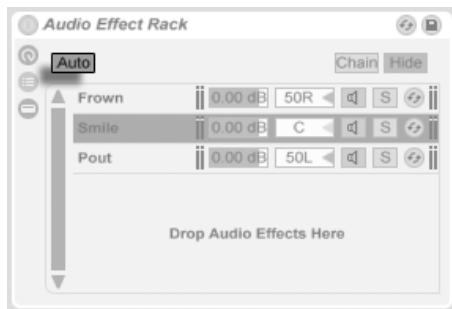

Auto Select in an Audio Effect Rack.



Auto Select in a Drum Rack.

When the Auto Select switch is activated, every chain that is currently processing signals becomes selected in the Chain List. In Drum Racks, this feature will select a chain if it receives its assigned MIDI input note. In Instrument and Effect Racks, Auto Select works in conjunction with zones, which are discussed next, and is quite helpful when troubleshooting complex configurations.

17.5 Zones

Zones are sets of data filters that reside at the input of every chain in an Instrument or Effect Rack. Together, they determine the range of values that can pass through to the device chain. By default, zones behave transparently, never requiring your attention. They can be reconfigured, however, to form sophisticated control setups. The three types of zones, whose editors are toggled with the buttons above the Chain List, are *Key*, *Velocity*, and *Chain Select*. The adjacent *Hide* button whisks them out of sight.

Note: Audio Effect Racks do not have key or velocity zones, since these two zone types filter MIDI data only. Likewise, Drum Racks have no zones at all; they filter MIDI notes based on choosers in their chain lists.

Zones contain a lower, main section, used for resizing and moving the zone itself, and a narrow upper section that defines fade ranges. Resizing of either section is done by clicking and dragging on its right or left edges, while moving is accomplished by clicking and dragging a zone from anywhere except its edges.

17.5.1 Signal Flow through Zones

To understand how zones work, let's examine the signal flow in a MIDI Effect Rack. Our MIDI Effect Rack resides in the device chain of a MIDI track, and therefore processes MIDI signals. We will assume that it contains four parallel device chains, each containing one MIDI effect.

1. All MIDI data in the track is passed to its device chain, and therefore into the input of the MIDI Effect Rack.
2. Our MIDI Effect Rack has four device chains, all of which receive the same MIDI data at the same time.
3. Before any MIDI data can enter a device chain, it must be able to pass through every zone in that chain. Every chain in a MIDI Effect Rack has three zones: a key zone, a velocity zone and a chain select zone.
4. An incoming MIDI note gets compared to a chain's key zone. If the MIDI note lies within the key zone, it is passed to the next zone for comparison; if it does not, then we already know that the note will not be passed to that chain's devices.
5. The same comparisons are made for the chain's velocity and chain select zones. If a note also lies within both of these zones, then it is passed to the input of the first device in that chain.
6. The output of all parallel chains is mixed together to produce the MIDI Effect Rack's final output. If there happened to be another device following after the Rack in the track's device chain, it would now receive the Rack's output for processing.

17.5.2 Key Zones

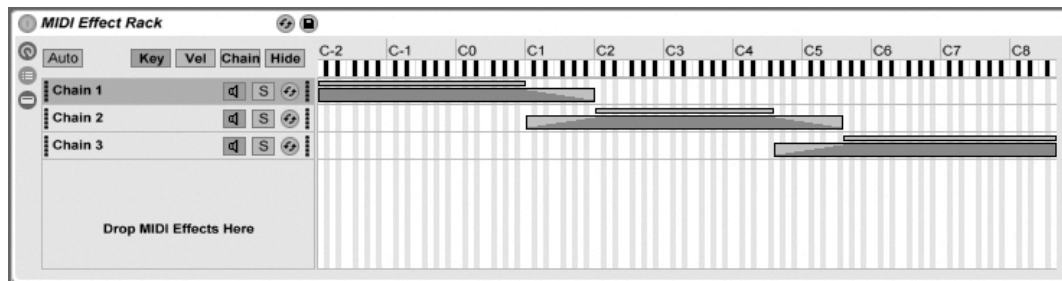

The Key Zone Editor.

When the Key button is selected, the Key Zone Editor appears to the right of the Chain List, illustrating how each chain maps to the full MIDI note range (nearly 11 octaves). Chains will only respond to MIDI notes that lie within their key zone. The zones of individual chains may occupy any number of keys, allowing for flexible “keyboard split” setups.

Key zone fade ranges attenuate the *velocities* of notes entering a chain.

17.5.3 Velocity Zones

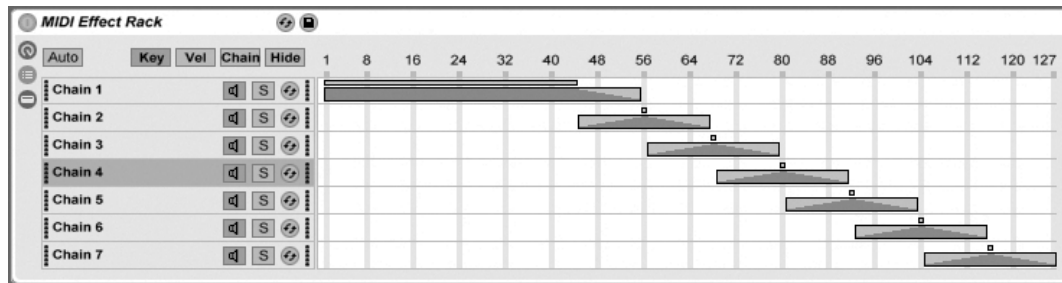

The Velocity Zone Editor.

Each chain in an Instrument Rack or MIDI Effect Rack also has a velocity zone, specifying the range of MIDI Note On velocities that it will respond to.

The Velocity Zone Editor, when displayed, replaces the Key Zone Editor to the right of the Chain List. MIDI Note On velocity is measured on a scale of 1-127, and this value range

spans the top of the editor. Otherwise, the functionality here is identical to that of the Key Zone Editor.

Velocity zone fade ranges attenuate the velocities of notes entering a chain.

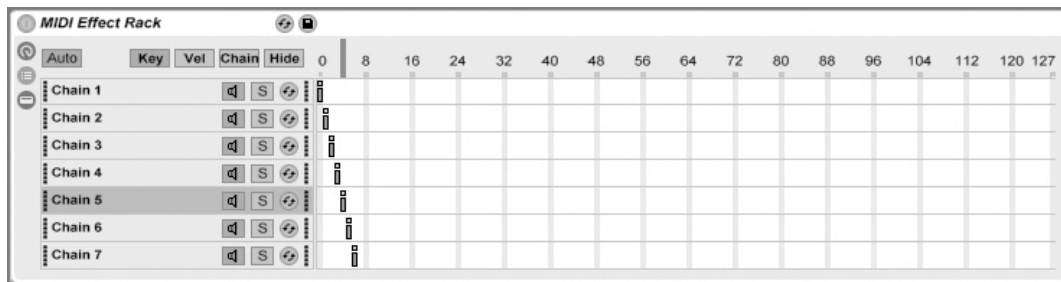

17.5.4 Chain Select Zones



The Chain Select Editor.

Activating the Chain button in an Instrument or Effect Rack displays the Chain Select Editor. These Racks have chain select zones, which allow you to filter chains spontaneously via a single parameter. The editor has a scale of 0-127, similar to the Velocity Zone Editor. Above the value scale, however, you will find a draggable indicator known as the Chain selector.

The chain select zone is a data filter just like the other zones; although all chains in a Rack receive input signals, only those with chain select zones that overlap the current value of the Chain selector can be addressed and thereby produce output.

By default, the chain select zones of Instrument and MIDI Effect Racks filter only notes, ignoring all other incoming MIDI events (such as MIDI CCs). To filter all MIDI events, enable the Chain Selector Filters MIDI Ctrl option, available in the context menu  (PC) /  (Mac) of a Rack's title bar or Chain Select Ruler.

In MIDI Effect Racks, fade ranges attenuate the velocities of notes entering a chain. In Instrument Racks and Audio Effect Racks, which both output audio signals, fade ranges attenuate the volume level at each chain's output. So what happens, then, if the Chain selector is moved outside of the chain select zone where a sound is currently playing? If the zone ends in a fade range, the chain's output volume is attenuated to zero while the Chain selector is outside of the zone. If the zone had no fade range, the output volume

is not attenuated, allowing the chain's effects (like long reverb tails or delays) to fade out according to their own settings.

Let's consider how we can make use of chain select zones in a performance situation:

Making Preset Banks Using Chain Select

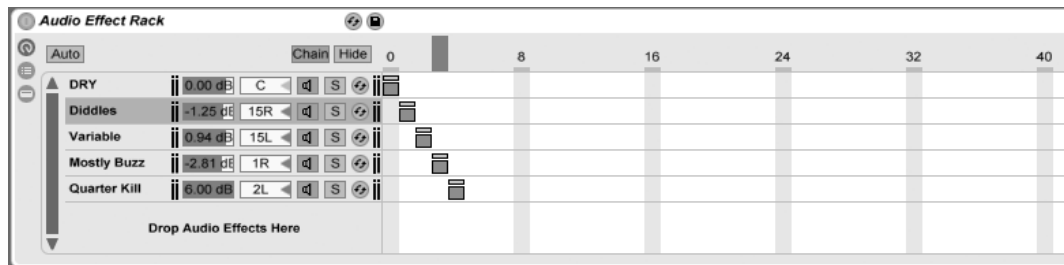

Using Chain Select Zones to Create Effects Presets.

Unlike the other zone types, the default length of a chain select zone is 1, and the default value is 0. From this setup, we can quickly create “preset banks” using the Chain Select Editor.

Again, we will use a Rack with four chains as our starting point. Each of the four chains contain different effects that we would like to be able to switch between. To make this a “hands-on” experience, we have MIDI-mapped the Chain selector to an encoder on an external control surface.

Let's move the chain select zones of the second and third chains so that each of our zones is occupying its own adjacent value: The first chain's zone has a value of 0, the second chain's zone has a value of 1, the third has a value of 2, and the fourth has a value of 3.

Since each of our chain select zones has a unique value, with no two zones overlapping, we now have a situation where only one chain at a time can ever be equal to the Chain selector value (shown at the top of the editor). Therefore, by moving the Chain selector, we determine which chain can process signals. With our MIDI encoder at hand, we can now flip effortlessly between instrument or effect setups.

Crossfading Preset Banks Using Fade Ranges

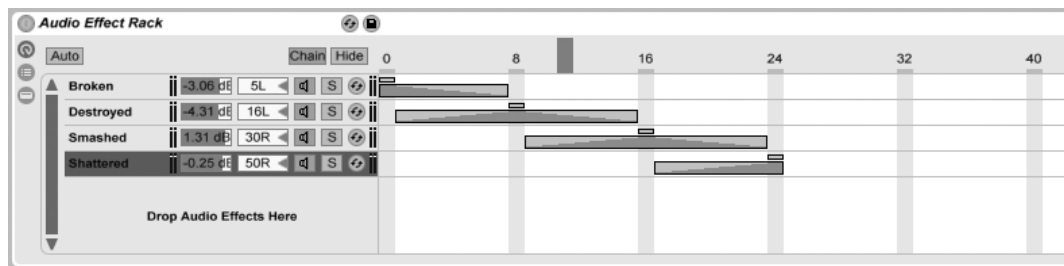

Crossfading Between Effects Presets Using Chain Select Zones.

Taking the previous example one step further, we can tweak our chain select zones to produce a smooth transition between our “presets.” To accomplish this, we will make use of our zones’ *fade ranges*.

To create some room for fading, let’s extend the length of our zones a bit. Setting the zones as shown maintains four exclusive values for our presets, so that each still has one point where neither of the others are heard. We crossfade between the presets over eight steps. If this is too rough a transition for your material, simply reposition the zones to maximize the fade ranges.

17.6 Drum Racks

We’ve already talked a bit about Drum Racks, and most of their features are the same as those found in Instrument and Effect Racks. But Drum Racks have a slightly different layout, some unique controls and special behavior that is optimized for creating drum kits.

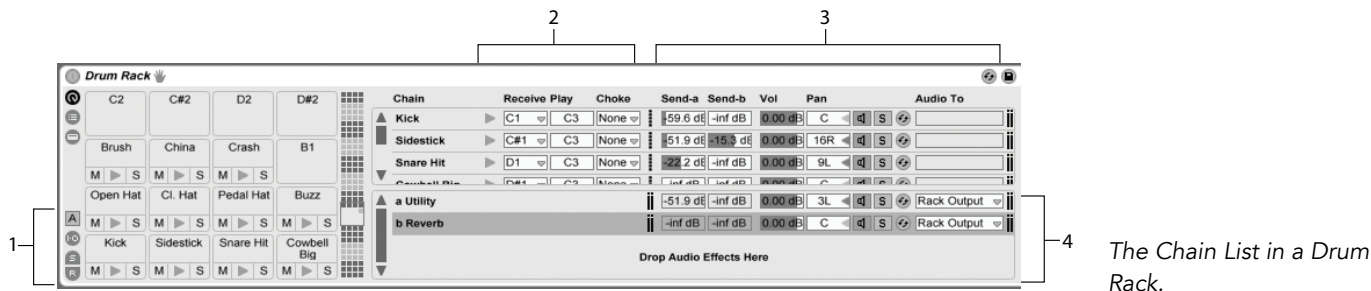

1. In addition to the standard selectors found on all Racks, Drum Racks have four additional controls in the view column. From top to bottom, these are the Auto Select button and toggles for the Input/Output, Send, and Return sections.
2. *Input/Output Section.* The Receive chooser sets the incoming MIDI note to which the drum chain will respond. The list shows note names, MIDI note numbers and standard GM drum equivalents. The Play slider sets the outgoing MIDI note that will be sent to the devices in the chain. The Choke chooser allows you to set a chain to one of sixteen *choke groups*. Any chains that are in the same choke group will silence the others when triggered. This is useful for choking open hihats by triggering closed ones, for example. If “All Notes” is selected in the Receive chooser, the Play and Choke choosers are disabled – in this case, the chain simply passes the note that it receives to its devices. The small Preview button to the left of these choosers fires a note into the chain, making it easy to check your mappings away from a MIDI controller.
3. *Mixer Section.* In addition to the mixer and Hot-Swap controls found in other Rack types, Drum Racks also have *send sliders*. These sliders allow you to set the amount of post-fader signal sent from each drum chain to any of the available return chains. Note that send controls are not available until return chains have been created.
4. *Return Chains.* A Drum Rack’s return chains appear in a separate section at the bottom of the chain list. Up to six chains of audio effects can be added here, which are fed by send sliders in each of the drum chains above.

The Audio To chooser in the mixer for return chains allows you to route a return chain’s output to either the main output of the Rack or directly to the return tracks of the Set. In

Drum Racks that are nested within other Drum Racks, both drum chains and return chains can route “upwards” to the returns of any of the Drum Racks that contain them.

17.6.1 Pad View

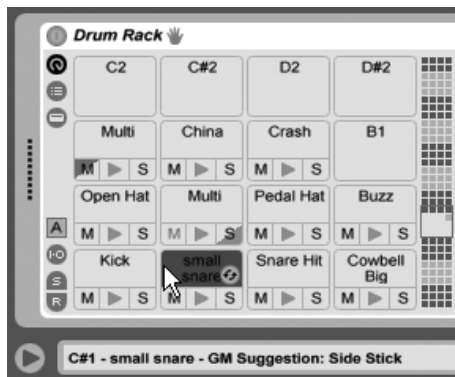



Pad View.

The Pad View is unique to Drum Racks and offers an easy way to map and manipulate samples and devices. Each pad represents one of the 128 available MIDI notes. The pad overview to the right shifts the set of visible pads up or down in octave increments, either by dragging the view selector to a new area or by using your computer keyboard’s \downarrow and \uparrow keys. Use the Alt (PC) / Command (Mac) modifier to shift the view by single rows instead.

Almost any object from Live’s Browser – samples, effects, instruments and presets – can be dragged onto a pad, mapping automatically to the pad’s note and creating or reconfiguring internal chains and devices as necessary. Dropping a sample onto an empty pad, for example, creates a new chain containing a **Simpler**, with the dropped sample ready to play from the pad’s note. If you then drag an audio effect to the same pad, it is placed downstream from the **Simpler** in the same chain. To replace the **Simpler**, simply drop another sample onto the same pad – any downstream audio effects or upstream MIDI effects will be left intact and only the **Simpler** and sample will be replaced.

If a multi-selection of samples is dropped onto an empty pad, new **Simplers** and chains will be mapped upwards chromatically from this pad, replacing any other samples that may have already been assigned to the pads in question (but, as before, leaving any effects devices alone). Alt (PC) / Command (Mac)-dragging a multi-selection layers all of the samples to

a single pad, by creating a nested Drum Rack with all of its chains set to receive that pad's note.

Dragging a pad to another pad swaps the note mapping between the pads. This means that any MIDI clips triggering the affected notes will now play the “wrong” sounds – although this might be exactly what you want.  (PC) /  (Mac)-dragging one pad to another will layer any chains from both pads in a nested Drum Rack.

You can always change your mappings from within the chain list as well, by adjusting the Receive choosers. The Pad View will update automatically to reflect your changes. If you set the same Receive note for multiple chains, that note's pad will trigger them all.



If you're working with lots of nested Racks, the inner structure can quickly become complicated. Pad View can make it much easier to work by letting you focus on only the top level: the notes and sounds. It's important to remember that a pad represents a note, rather than a chain. More specifically, it represents *all* chains, no matter how deep in the Rack, that are able to receive that pad's note. What you can control with each pad is related to how many chains it represents:

- An empty pad shows only the note it will trigger. When you mouse over it, the Status Bar will display this note, as well as the suggested GM instrument.
- A pad that triggers only one chain shows the name of the chain. In this case, the pad serves as a handy front-end for many controls that are normally accessed in the chain list, such as mute, solo, preview and Hot-Swap. You can also rename and delete the chain via the pad.
- A pad that triggers multiple chains shows “Multi” as its name, and its mute, solo and preview buttons will affect all of its chains. If you mute and solo chains individually within the chain list, the pad's icons reflect this mixed state. Hot-Swap and renaming are disabled for a Multi pad, but you can delete all of its chains at once.

Although Pad View is designed for easy editing and sound design, it also excels as a *performance* interface, particularly when triggered by a hardware control surface with pads. If your pad controller is one of Ableton's [natively supported control surfaces](#), simply select it as a control surface in the MIDI/Sync tab of Live's Preferences. From then on, as long as you have a Drum Rack on a track that's receiving MIDI, your pad controller will trigger the pads that are visible on your screen. If you scroll the pad overview to show a different set of pads, your controller will update automatically.

17.6.2 Slicing

Although Live automatically warps audio files to match your Set's tempo, you can get even more flexibility out of your loops via a process called *slicing*. Slicing involves dividing the audio into small chunks and assigning each chunk to a single MIDI note, leaving your original audio file unaffected. The Drum Rack provides an ideal environment for working with sliced files, and most of the setup happens automatically.

To get started, select an audio clip from within your Set or the Browser, click  (PC) /  (Mac) to open the clip's context menu, and select the Slice to New MIDI Track command:

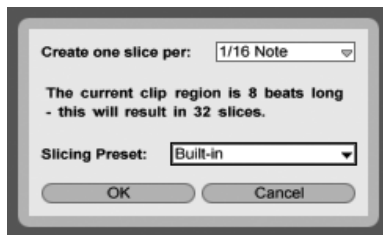

The Slicing Dialog.

The Slicing dialog offers a list of slicing divisions, as well as a chooser to select the Slicing Preset. The top chooser allows you to slice at a variety of beat resolutions or according to the clip's transients or Warp Markers. Since a Rack can contain a maximum of 128 chains, Live won't let you proceed if your choice would result in more than 128 slices. You can fix this by either setting a lower slice resolution or by selecting a smaller region of the clip to slice. If your audio file is in [REX format](#), the slicing will be based on the file's internal timing information and you won't see this chooser.

The Slicing Preset chooser contains a few Ableton-supplied slicing templates, as well as any of your own that you may have placed in your Library's [default presets folder](#).

Once you've made your slicing choices and clicked OK, a number of things will happen:

1. A new MIDI track will be created, containing a MIDI clip. The clip will contain one note for each slice, arranged in a chromatic sequence.
2. A Drum Rack will be added to the newly created track, containing one chain per slice. Each chain will be triggered by one of the notes from the clip, and will contain a Simpler with the corresponding audio slice loaded.

3. The Drum Rack's Macro Controls will be pre-assigned to useful parameters for the Simplers, as determined by the settings in the selected slicing preset. In the factory Slicing presets, these include basic envelope controls and parameters to adjust the loop and crossfade properties of each slice. Adjusting one of these Macros will adjust the mapped parameter in each Simpler simultaneously.

Note: Live will take a few moments to process all of this information.

Playing the MIDI clip will trigger each chain in the Drum Rack in order, according to the timing information that you specified or that was embedded in the audio. This opens up many new editing possibilities, including:

Resequencing Slices

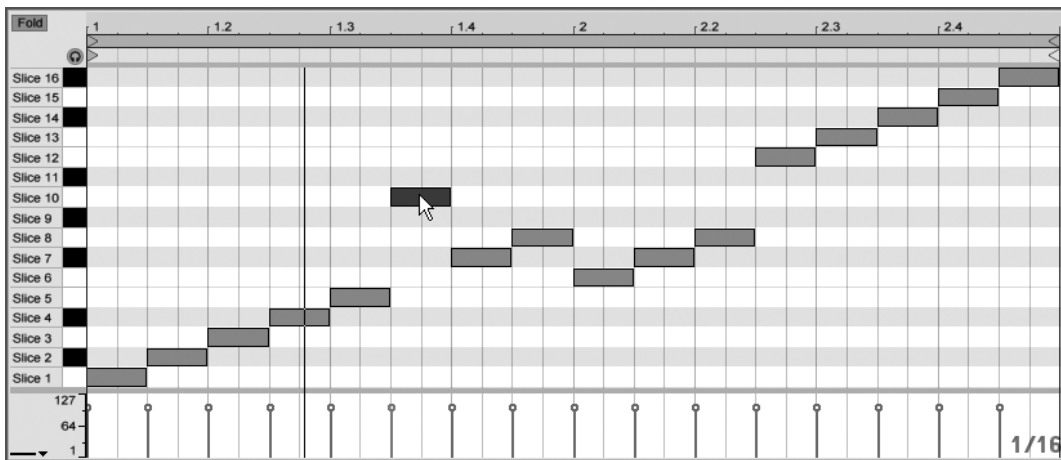

Rearranging the Sliced MIDI Data.

By default, your sliced MIDI data will form a chromatically-ascending “staircase” pattern in order to trigger the correct chains in their original order. But you can create new patterns by simply **editing the MIDI notes**. You can achieve a similar effect by dragging the Drum Rack's pads onto each other to swap their note mappings.

Using Effects on Slices

Because each slice lives in its own chain in the Drum Rack, you can easily process individual slices with their own audio effects. To process several slices with the same set of effects, multi-select their chains in the Drum Rack's chain list and press **Ctrl**-G to group them to their own nested Rack. Then insert the effects after this new sub-Rack.

For even more creative possibilities, try inserting **MIDI effects** before the Drum Rack. The Arpeggiator and Random devices can yield particularly interesting results.

Slicing is most commonly applied to drum loops, but there's no reason to stop there. Experiment with slicing audio from different sources, such as voices and ambient textures. The same sorts of resequencing and reprocessing operations can be applied to anything you slice – sometimes with unexpected results.

17.7 Using the Macro Controls

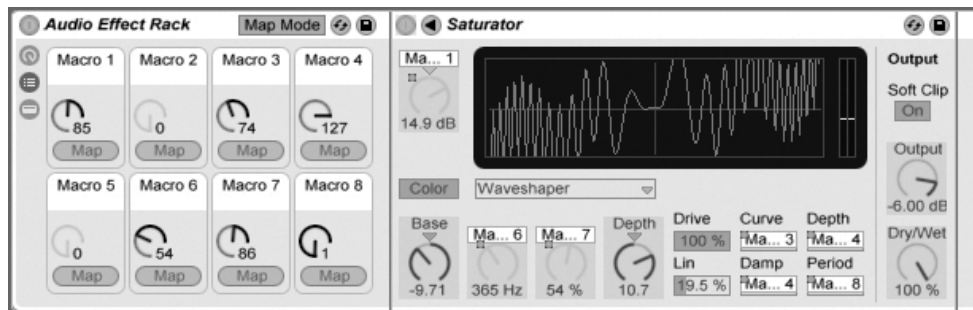

Making Macro Control Assignments in Map Mode.



With the potential for developing complex device chains, Macro Controls keep things manageable by taking over the most essential parameters of a Rack (as determined by you, of course). Once you have set up your ideal mapping, the rest of the Rack can be hidden away.

The Macro Control view's dedicated *Map Mode* button opens the door to this behavior. Enabling Macro Map Mode causes three things to happen:

- All mappable parameters from a Rack's devices will appear with a colored overlay;

- Map buttons will appear beneath each Macro Control dial;
- The **Mapping Browser** will open.



The following steps will get you started mapping:

1. Enable Macro Map Mode by clicking the Map Mode button;
2. Select a device parameter for mapping by clicking it once;
3. Map the parameter by clicking on any Macro Control's Map button. The details will be added to the Mapping Browser. By default the Macro will take its name and units from the device parameter it is controlling.
4. Refine the value range if desired using the Min/Max sliders in the Mapping Browser. Inverted mappings can be created by setting the Min slider's value greater than the Max slider's value. The current values can also be inverted by pressing  (PC) /   (Mac) on the entry in the Mapping Browser.
5. Select another device parameter if you'd like to create more mappings, or click on the Map Mode button once more to exit Macro Map Mode.

Note that once assigned to a Macro Control, a device parameter will appear disabled, since it hands over all control to the Macro Control (although it can still be modulated externally, via **Clip Envelopes**).

You can edit or delete your assignments at any time using the Mapping Browser (which only appears when Map Mode is enabled).

If more than one parameter is assigned to a single Macro, the Macro's name will revert to its generic name (e.g., Macro 3). The Macro's units will also change to a 0 to 127 scale, except when all parameters possess both the same unit type and the same unit range.

Macro controls can be given custom names, colors and **info text** entries via the corresponding commands in the Edit menu or the  (PC) /   (Mac) context menu.

17.8 Mixing With Racks

Any Instrument or Drum Rack that contains more than one chain can be viewed and mixed alongside the tracks in the Session View's mixer. A track that contains these Racks will have

a  button in its title bar, which will fold the Rack's mixer in or out. Likewise, any nested chains within the Rack will also have this button. This makes it easy to get an overview of your Rack's hierarchy – or hide it when you just want to work on your mix.

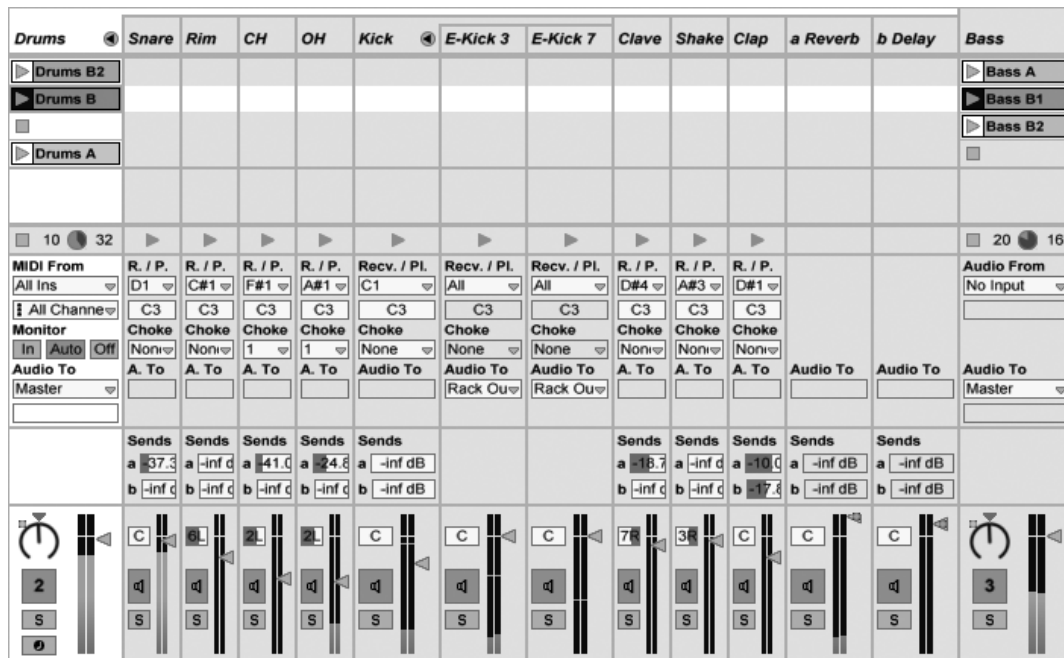

The screenshot displays a software mixer interface with a rack of chains. The rack is organized into columns for different instruments and effects: Drums (Snare, Rim, CH, OH, Kick, E-Kick 3, E-Kick 7), Clave, Shake, Clap, a Reverb (a), Delay (b), and Bass (Bass A, Bass B1, Bass B2). Each chain has a mixer with various controls like R./P., Recv./Pl., Choke, Audio To, and Sends. The interface also shows MIDI From, Monitor, and Audio From/To settings for each chain.

Mixing Rack Chains in the Session View.

Chains in the Session View mixer look similar to tracks, but they have no clip slots. Their mixing and routing controls mirror those found in the Rack's chain list, so any changes made to these controls in either area will be reflected in the other immediately. Likewise, many chain operations such as reordering, renaming and regrouping can be performed from either the mixer or the chain list. Clicking in a chain's mixer title bar shows only that chain's devices in the Track View.

As with tracks, when chains are multiselected in the Session View mixer, adjusting a mixer parameter for one of the chains will adjust the same parameter in the other selected chains. Note that this behavior only applies to parameters adjusted via the Session mixer and not when adjusting the same parameters in the Rack's chain list.

17.8.1 Extracting Chains

All chains can be dragged from their parent Racks and placed into other tracks or Racks, either from the chain list or from the Session View mixer. A Drum Rack's return chains can also be extracted, and will create new return tracks if dragged to the mixer. Drum chains have an additional feature: when dragged from the mixer to a new track, they take their MIDI notes with them. For example, if you are working on a MIDI drum loop within a single track and decide that you would like to move just the snare onto its own track, simply select the snare chain's title bar in the mixer and drag it to the mixer's drop area. This creates a new track with the full contents of the snare chain: both its devices and its MIDI data. If you would like to extract only the devices, drag from the chain list instead of from the mixer.



Extracting Drum Chains in the Mixer Extracts MIDI Data.

Chapter 18

Automation and Editing Envelopes

Often, when working with Live's mixer and devices, you will want the controls' movements to become part of the music. The movement of a control across the song timeline is called *automation*; a control whose value changes in the course of this timeline is *automated*. Practically all mixer and device controls in Live can be automated, including the song tempo.

18.1 Recording Automation

Creating automation is straightforward: All changes of a control that occur while the Control Bar's Record switch is on become automation. Try recording automation for a control, for instance a mixer volume slider. After recording, play back what you have just recorded to see and hear the effect of the control movement. You will notice that a little LED has appeared in the slider thumb to indicate that the control is now automated. Try recording automation for track panning and the Track Activator switch as well; their automation LEDs appear in their upper left corners.

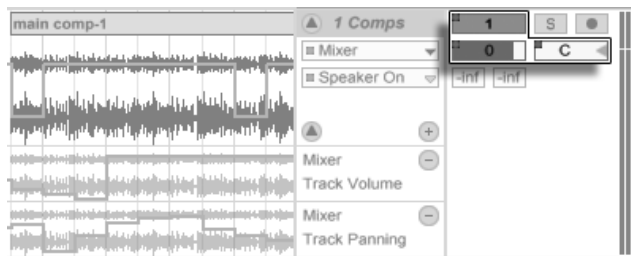

Volume, Pan and the Track Activator Switch Have Been Automated.

18.2 Deleting Automation

To delete automation data, (PC) / (Mac) on an automated control to open its context menu and select Delete Automation. The automation LED disappears, and the control's value stays constant across the entire song. You can also delete automation by editing [breakpoint envelopes](#).

18.3 Overriding Automation

In practice, you will often want to try out new control moves without overwriting existing automation data. Well, nothing is forever in the world of infinite [Undo](#), but it's easy to disable a control's automation temporarily to avoid overwriting existing data: If you change an automated control's value while *not* in Record mode, the automation LED goes off to indicate the control's automation is inactive. Any automation is therefore *overridden* by the current manual setting.



The Back to Arrangement Button.

When one or more of the automated controls in your Live Set are not active, the Control Bar's Back to Arrangement button lights up. This button serves two purposes:

1. It reminds you that the current state of the controls differs from the state captured in the Arrangement.

2. You can click on it to reactivate all automation and thereby return to the automation state as it is written “on tape.”

18.4 Drawing and Editing Automation

In the Arrangement View, automation curves can be viewed and edited as breakpoint envelopes.

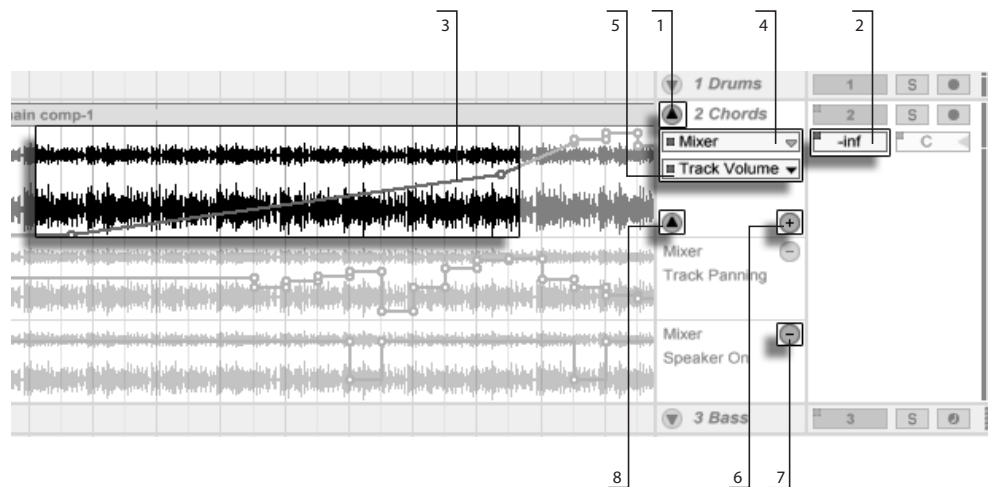



Automation Envelopes in the Arrangement View.



1. To show a track's envelopes, “unfold” the track by clicking the ▼ button next to the track name. (Note that, for **Group Tracks**, you may need to expand the track's height in order to see its envelopes.)
2. Clicking on one of the track's mixer or device controls will display this control's envelope on the clip track.
3. Envelopes appear “on top of” the audio waveform or MIDI display. An envelope's vertical axis represents the control value and the horizontal axis represents time. For switches and radio buttons, the value axis is discontinuous.
4. The Fades/Device chooser either selects **audio clip fades**, the track mixer, one

of the track's devices or "None" to hide the envelope. It also provides you with an overview of which devices actually have automation by showing an LED next to their labels. You can make things clearer still by selecting "Show Automated Parameters Only" from the bottom of the chooser.

5. The Automation Control chooser selects a control from the device chosen in the Fades/Device chooser. The labels of automated controls have an LED.

Once an envelope has been selected on the track, several new buttons appear:

6. The  button moves the envelope into its own *automation lane* below the clip. You can then select another automation parameter from the choosers to view it simultaneously. If the Fades/Device chooser is set to "None", this button will be hidden.
7. The  button hides its respective automation lane. Note that hiding a lane from view does not deactivate its envelope.
8. If any automation lanes have been created for a given track, you can hide or show them all by clicking the additional  button that appears at the bottom of the track's title bar.

Clicking  (PC) /  (Mac) on a track name or automation lane header opens a context menu with additional options for viewing envelopes. This context menu also contains commands to quickly clear all automation envelopes for the track or any of its devices.

18.4.1 Drawing Envelopes

With Draw Mode enabled, you can click and drag to "draw" an envelope curve.

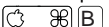

The Draw Mode Switch.

To toggle Draw Mode, select the Draw Mode option from the Options menu, click on the Control Bar's Draw Mode switch, or press  (PC) /  (Mac).

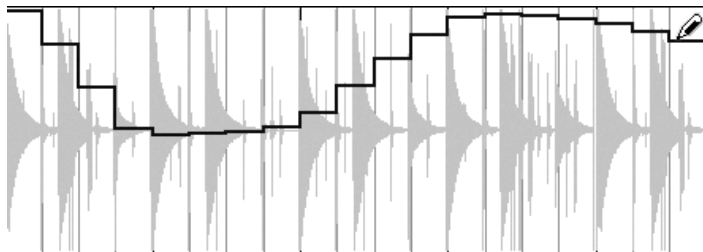

Drawing an Envelope.

Drawing creates steps as wide as the visible grid, which you can modify using a **number of handy shortcuts**. For freehand drawing, you can hide the grid using the Snap to Grid Options menu entry or the **Ctrl** + **4** (PC) / **⌘** + **4** (Mac) shortcut. To temporarily enable freehand drawing while the grid is shown, hold down **Alt** (PC) / **Alt** + **⇧** (Mac) while drawing.

18.4.2 Editing Breakpoints

With Draw Mode off, the envelope display looks and works differently. The line segments and the breakpoints connecting them become draggable objects. Clicking and dragging in the envelope's background defines a selection. Here is what you can do:

- Double-click at a position on a line segment to create a new breakpoint there.
- Double-click on a breakpoint to delete it.
- Click and drag a breakpoint to move it to the desired location. If the breakpoint you are dragging is in the current selection, all other breakpoints in the selection will follow the movement.

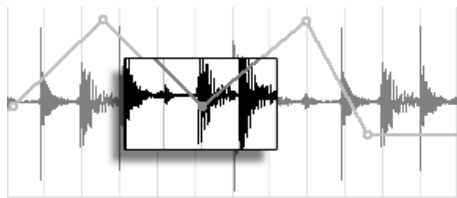

To Move all Breakpoints Within the Selection, Drag Any One of Them.

Your movement is constrained by the neighboring breakpoints unless you hold down the **⇧** modifier while dragging, which will eliminate breakpoints as you wipe over

them. Holding down the **Ctrl** (PC) / **⌘** (Mac) modifier while dragging switches to a finer resolution.

- Click and drag a line segment between two breakpoints to move it vertically, without affecting the breakpoint's horizontal position. If the line segment is in the current selection, the envelope is moved vertically across the selected timespan. Live inserts breakpoints at the selection's edges to make sure the move only affects the selected part of the envelope.

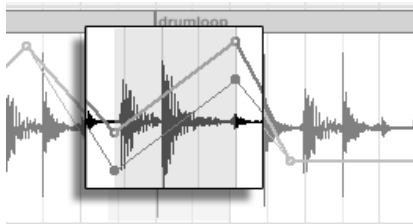

Dragging an Envelope Line Segment Moves the Segment Vertically.

18.4.3 Locking Envelopes

When moving clips, Live normally moves all automation with the clip. Sometimes, you might want to lock the envelopes to the song position rather than to the clips, and the Arrangement View's Lock Envelopes switch does just that.

You can also choose to lock envelopes from the Options menu.



The Lock Envelopes Switch.

18.4.4 Edit Menu Commands

When working with automation data, the Edit menu commands behave differently depending on whether or not your selection is within the clip track or its automation lanes.

To copy, cut, delete or duplicate automation from a track, independent of the associated clip, make sure the parameter you want to work with is in its own lane. Any edit commands applied to an envelope selection within a single lane will only apply to this envelope. The clip itself will be unaffected. You can also work with envelopes in multiple lanes simultaneously.

If you want your edits to apply to both the clip *and* all of its associated envelopes, apply edit commands to a selection in the clip track.

Note that Live allows you to copy and paste envelope movements not only from one point in time to another, but also from one parameter to another. Since the parameters may be completely unrelated, this can have unexpected (but possibly interesting) results.

18.4.5 Editing the Tempo Automation

The ability to dynamically stretch and compress audio to track any tempo or tempo variation is one of Live's specialties. In Live, the song tempo is just another automated control.

To edit the song tempo envelope, unfold the Master track, choose "Mixer" from the top envelope chooser and "Song Tempo" from the bottom one.

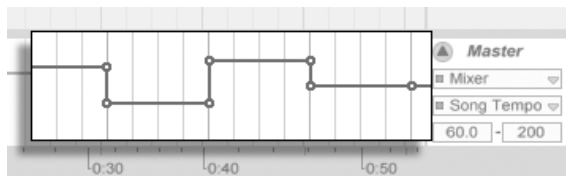

The Tempo Envelope.

When adjusting the tempo envelope, you might want to scale the value axis display, which is the function of the two value boxes below the envelope choosers: The left box sets the minimum, and the right box sets the maximum tempo displayed, in BPM.

Note that these two controls also determine the value range of a **MIDI controller** assigned to the tempo.

Chapter 19

Clip Envelopes

Every clip in Live can have its own *clip envelopes*. The aspects of a clip that are influenced by clip envelopes change depending upon clip type and setup; clip envelopes can do anything from representing MIDI controller data to modulating device parameters. In this chapter, we will first look at how all clip envelopes are drawn and edited, and then get into the details of their various applications.

19.1 The Clip Envelope Editor



Use the Clip View Box Selector to Bring up the Envelopes Box.

To work with clip envelopes, bring up the Clip View's Envelopes box by activating the rightmost Clip View Box selector panel. The Envelopes box contains two choosers for selecting an envelope to view and edit.

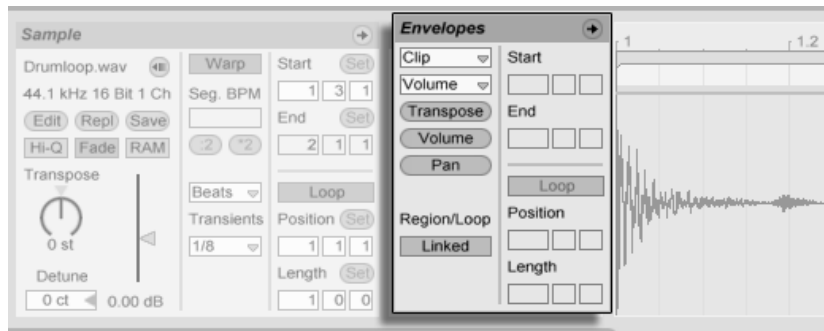

The Clip View's Envelopes Box.

The top menu is the Device chooser, which selects a general category of controls with which to work. Device chooser entries are different for different kinds of clips:

- Audio clips have entries for “Clip” (the clip’s sample controls), every effect in the track’s device chain and the mixer.
- MIDI clips have entries for “MIDI Ctrl” (MIDI controller data) and every device in the track’s device chain.











The bottom menu, the Control chooser, selects among the controls of the item chosen in the top menu. In both choosers, parameters with altered clip envelopes appear with LEDs next to their names. You can simplify the appearance of these choosers by selecting “Show Modulated Parameters Only” from either of them.

The “quick-chooser” buttons below the menus select commonly edited controls.

Clicking the menus or the quick-chooser buttons brings up the Envelope Editor showing the selected envelope, instead of the Sample Display or MIDI Editor. You can toggle the display by clicking on the title bars of the Sample/Notes and Envelopes boxes.

The techniques for drawing and editing clip envelopes are the same as those for automation envelopes in the [Arrangement View](#).

If you create a nice section of envelope that you want to have repeat several times, try the following:

1. Enclose the desired selection in the loop brace, and click the brace so that it is selected. This will execute the Edit menu's Select Loop command, which selects all material in the loop.
2. Copy the envelope with   (PC) /    (Mac).
3. Shift the loop brace to the right by one loop length with .
4. Paste the envelope with   (PC) /    (Mac).

Note that you can use the arrow keys to quickly **manipulate the loop brace and start/end markers** in other useful ways to expedite clip envelope editing tasks.

To delete a clip envelope (i.e., to set it back to its default value), first go to Edit/Select All, then to Edit/Delete.

Let us now look at some uses of clip envelopes.

19.2 Audio Clip Envelopes

Clip envelopes extend Live's "elastic" approach to audio and, in conjunction with Live's audio effects, turn Live into a mighty sound-design tool. Using clip envelopes with audio clips, you can create an abundance of interesting variations from the same clip in real time – anything from subtle corrections to entirely new and unrelated sounds.

19.2.1 Clip Envelopes are Non-Destructive

Using clip envelopes, you can create new sounds from a sample without actually affecting the sample on disk. Because Live calculates the envelope modulations in real time, you can have hundreds of clips in a Live Set that all sound different, but use the same sample.

You can, of course, export a newly created sound by **rendering**, or by **resampling**. In the Arrangement View, you can use the **Consolidate command** to create new samples.

19.2.2 Changing Pitch and Tuning per Note

Drop a sample loop from the Browser into Live and play it. Click on the Transpose quick-chooser button. You can now alter the pitch transposition of individual notes in the sample as you listen to it.

The fast way to do this is by enabling **Draw Mode** and drawing steps along the grid. Deactivate Draw Mode to edit breakpoints and line segments. This is useful for smoothing the coarse steps by horizontally displacing breakpoints.

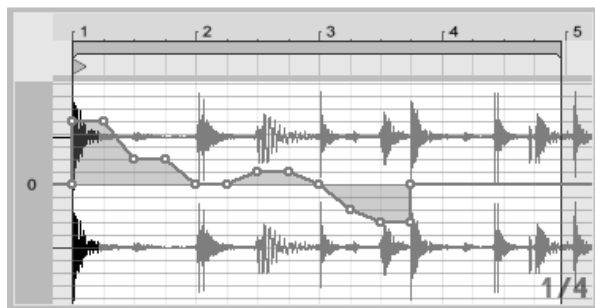
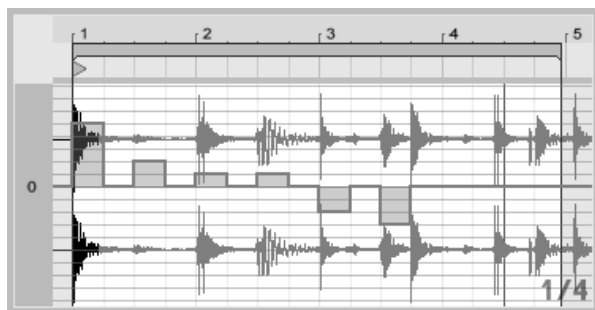

The Transposition Envelope with Steps (Top) and Ramps (Bottom).

Note that the warp settings determine how accurately Live's time-warping engine tracks the envelope shape. To obtain a more immediate response, reduce the Grain Size value in Tones and Texture Mode or choose a smaller value for the Transients control in Beats Mode.

To correct the tuning of individual notes in the sample, hold down the **Ctrl** (PC) / **⌘** (Mac) modifier while drawing or moving breakpoints to obtain a finer resolution.

To scroll the display, hold down the **Ctrl** **Alt** (PC) / **⌘** **Alt** (Mac) modifier while dragging.

Pitch is modulated in an *additive* way. The output of the transposition envelope is simply added to the Transpose control's value. The result of the modulation is clipped to stay in the available range (-48..48 semitones in this case).

19.2.3 Muting or Attenuating Notes in a Sample

Click on the Volume quick-chooser to access an audio clip's volume envelope. By drawing steps in Draw Mode or creating shapes with breakpoints, you can impose an arbitrary volume shape onto the sample.

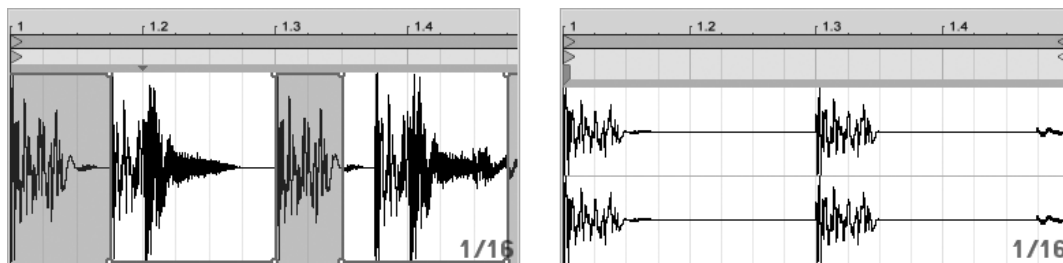

Imposing a Volume Envelope on a Sample.

The volume envelope's output is interpreted as a relative percentage of the clip volume slider's current value. The result of the clip envelope's modulation can therefore never exceed the absolute volume setting, but the clip envelope can drag the audible volume down to silence.

19.2.4 Scrambling Beats

One very creative use of clip envelopes is to modulate the sample offset. Sample offset modulation makes the most sense for rhythmical samples, and is only available for clips that are set up to run in the Beats Warp Mode.

Try sample offset modulation with a one-bar drum loop: Make sure Beats Mode is chosen; in the Envelopes box, choose "Clip" from the Device chooser and "Sample Offset" from

the Control chooser. The Envelope Editor appears with a vertical grid overlay. In **envelope Draw Mode**, set steps to non-zero values to hear the loop scrambled. What is going on?

Imagine the audio is read out by a tape head, the position of which is modulated by the envelope. The higher a value the envelope delivers, the farther away the tape head is from its center position. Positive envelope values move the head towards the “future,” negative values move it towards the “past.” Fortunately, Live performs the modulation in beats rather than centimeters: A vertical grid line is worth a sixteenth note of offset and the modulation can reach from plus eight sixteenths to minus eight sixteenths.

Sample offset modulation is the tool of choice for quickly creating interesting variations of beat loops. We discourage using this technique for “analytical” cut-and-splice tasks; they are much easier to perform using Live’s Arrangement View, and the results can easily be **consolidated into new clips**.

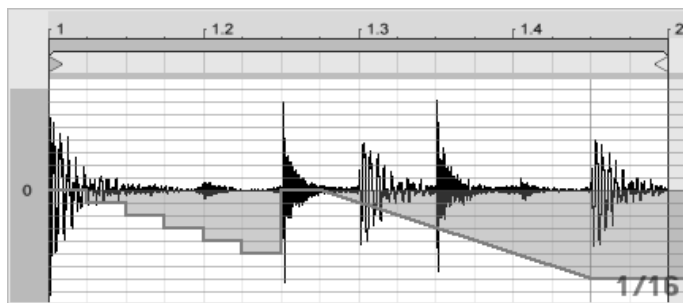

Repeating Steps and Slowing Time with the Sample Offset Envelope.

Some sample offset envelope gestures have a characteristic effect: a downward “escalator” shape, for instance, effectively repeats the step at the envelope’s beginning. Similarly, a smooth ramp with a downwards slope is slowing time and can create nice slurring effects when the slope is not quite exactly 45 degrees; try this with a 1/32 Transients setting.

19.2.5 Using Clips as Templates

As you are making creative use of clip envelopes, the clips containing them develop a life of their own, independent of the original sample. You might wonder at a point: What does this clip sound like with a different sample? This is easy to find out by selecting the clip so that it is displayed in the Clip View and dragging the desired sample from one of the

File Browsers, or the Session or Arrangement View, onto the Clip View. All clip settings, including the envelopes, will remain unaltered; only the sample will be replaced.

19.3 Mixer and Device Clip Envelopes

Clip envelopes can be used to *modulate* mixer and device controls. Since mixer and device controls can also be controlled by the Arrangement's **automation envelopes**, this is a potential source of confusion. However, clip envelopes differ from automation envelopes in one important way: Whereas automation envelopes *define* the value of a control at any given point in time, clip envelopes can only *influence* this defined value. This difference allows the two types of envelopes to work together in harmony when controlling the same parameter.

Imagine that you have recorded volume automation for an audio clip so that it gradually fades out over four bars. What happens to your fade-out when you create a clip envelope that gradually increases the mixer volume over four bars? At first, your fade-out will become a crescendo, as the clip envelope gradually increases the volume within the range allowed by the automation envelope. But, once the decreasing automated value meets with the increasing clip envelope value, the fade-out will begin, as automation forces the absolute control value (and the operable range of the clip envelope) down.

19.3.1 Modulating Mixer Volumes and Sends

Notice that there are actually two volume modulations: Clip Volume and Mixer Volume. The latter is a modulation for the mixer's gain stage and therefore affects the post-effect signal. To prevent confusion, a small dot below the mixer's volume slider thumb indicates the actual, modulated volume setting.

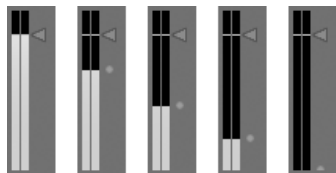

Modulating the Mixer Volume. The Little Dot Below the Volume Slider Thumb Represents the Modulated Volume Setting.

As you raise and lower the Volume slider, you can observe the dot following your movement in a relative fashion.

Modulating the track's Send controls is just as easy. Again, the modulation is a relative percentage: The clip envelope cannot open the send further than the Send knob, but it can reduce the actual send value to minus infinite dB.



Modulating a Send. The Send Knob's Position Ring Indicates the Modulated Value.

19.3.2 Modulating Pan

The Pan envelope affects the mixer pan stage in a relative way: The pan knob's position determines the intensity of the modulation. With the pan knob set to the center position, modulation by the clip envelope can reach from hard left to hard right; the modulation amount is automatically reduced as you move the pan knob towards the left or right. When the pan knob is turned all the way to the left, for instance, the pan clip envelope has no effect at all.

19.3.3 Modulating Device Controls

All devices in a clip's track are listed in the upper clip envelope Device chooser. Modulating the devices' controls works just as you would expect. When modulating device controls, it is important to keep the interaction of clip envelopes and device settings in mind: Unlike a [device preset](#), the clip envelope cannot define the values for the devices' controls, it can only *change* them relative to their current setting.

19.4 MIDI Controller Clip Envelopes

Whether you are working with a new MIDI clip that was [recorded](#) directly into Live, or one from your files, Live allows you to edit and create MIDI controller data for the clip in the form of clip envelopes.

Choose “MIDI Ctrl” from a MIDI clip’s Device chooser and use the Control chooser below it to select a specific MIDI controller. You can create new clip envelopes for any of the listed controllers by drawing steps or using breakpoints. You can also edit clip envelope representations of controller data that is imported as part of your MIDI files or is created while recording new clips: Names of controllers that already have clip envelopes appear with an adjacent LED in the Control chooser.

Live supports most MIDI controller numbers up to 119, accessible via the scroll bar on the right side of the menu. Note that devices to which you send your MIDI controller messages may not follow the conventions of MIDI control channel assignments, so that “Pitch Bend” or “Pan,” for example, will not always achieve the results that their names imply.

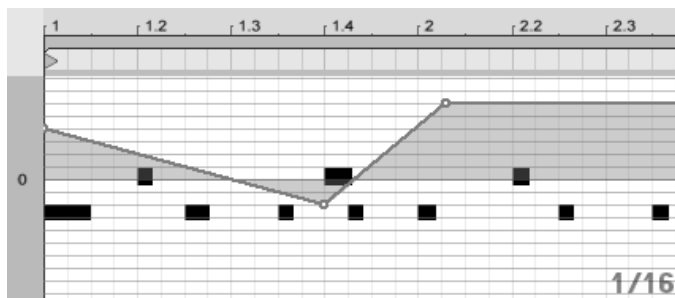

A MIDI Controller Clip Envelope.

Many of the techniques described in the following section on [unlinking a clip envelope](#) from its associated clip can be adapted for use with MIDI controller clip envelopes.

19.5 Unlinking Clip Envelopes From Clips

A clip envelope can have its own local loop/region settings. The ability to unlink the envelope from its clip creates an abundance of exciting creative options, some of which we will present in the rest of this chapter.

19.5.1 Programming a Fade-Out for a Live Set

Let us start with a straightforward example. Suppose you are setting up a Live Set and wish to program a fade-out over eight bars to occur when a specific clip is launched – but all you have is a one-bar loop.

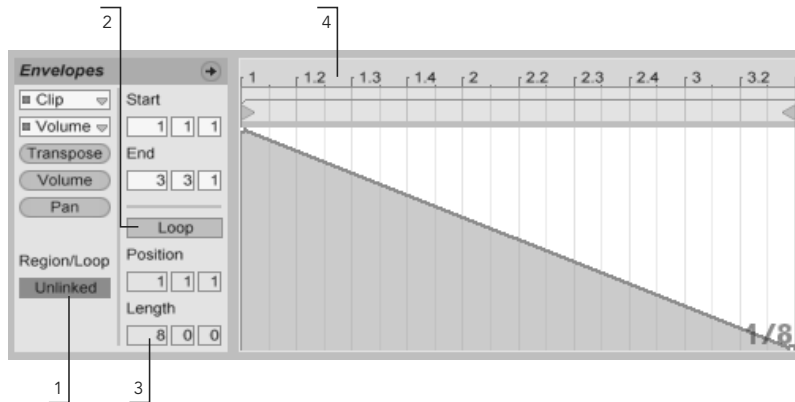

Using a Clip Envelope to Create a Fade-Out Over Several Repetitions of a Loop.

1. Choose the Clip Volume envelope, and *unlink* it from the sample.

The clip envelope’s loop braces now appear colored to indicate this envelope now has its own local loop/region settings. The loop/region controls in the Envelopes box “come to life.”

2. Make sure the clip envelope’s Loop switch is off. Notice the Sample box’s Loop switch is not affected. The sample will keep looping although the envelope is now playing as a “one-shot.”
3. Type “8” into the leftmost envelope loop-length value box.
4. Zoom the envelope display out all the way by clicking on the Envelope’s time ruler and dragging upwards.
5. Insert a breakpoint at the region end and drag it to the bottom (zero percent).

Now, as you play the clip, you can hear the one-bar loop fading out over eight bars.

Please note: toggling Linked Mode changes the envelope data. Toggling back and forth

effectively deletes the envelope data. To return to the previous state, please use the Edit menu's Undo command.

19.5.2 Creating Long Loops from Short Loops

Let us take this a step further. For a different part of your set, you would like to use the same one-bar loop – because it sounds great – but its repetition bores you. You would like to somehow turn it into a longer loop.

We depart from the clip we just set up to fade out over eight bars. Activate the clip volume envelope's Loop switch. Now, as you play the clip, you can hear the eight-bar fade-out repeating. You can draw or edit any envelope to superimpose onto the sample loop. This, of course, not only works for volume but for any other control as well; how about a filter sweep every four bars?

Note that you can create as much time as needed in the Envelope Editor, either by dragging the loop braces beyond the view limit, or by entering values into the numeric region/loop controls.

You can choose an arbitrary loop length for each envelope, including odd lengths like 3.2.1. It is not hard to imagine great complexity (and confusion!) arising from several odd-length envelopes in one clip.

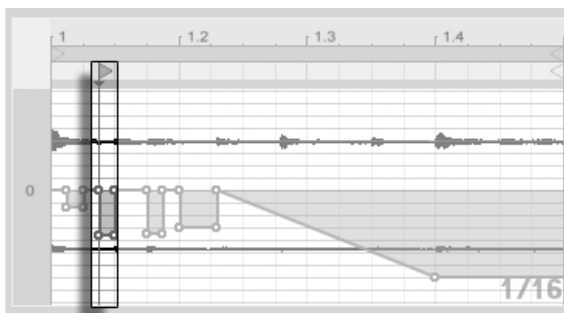
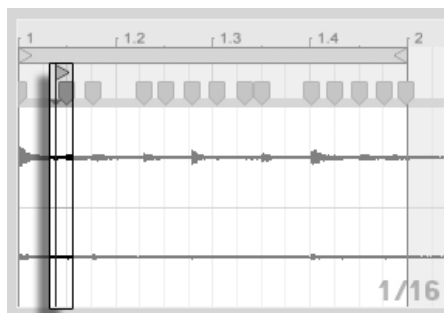

The Sample (Left) and Envelope (Right) Start Marker.

To keep this complexity under control, it is important to have a common point of reference. The start marker identifies the point where sample or envelope playback depart from when the clip starts.

Note that the start/end markers and loop brace are subject to [quantization by the zoom-adaptive grid](#), as is [envelope drawing](#).

19.5.3 Imposing Rhythm Patterns onto Samples

So far, we have been talking about imposing long envelopes onto small loops. You can also think of interesting applications that work the other way around. Consider a sample of a song that is several minutes long. This sample could be played by a clip with a one-bar volume envelope loop. The volume envelope loop now works as a pattern that is repeatedly “punching” holes into the music so as to, perhaps, remove every third beat. You can certainly think of other parameters that such a pattern could modulate in interesting ways.

19.5.4 Clip Envelopes as LFOs

If you are into sound synthesis, you may want to think of a clip envelope with a local loop as an LFO. This LFO is running in sync with the project tempo, but it is also possible to set up a loop period odd enough to render the envelope unsynchronized. By [hiding the grid](#), you can adjust the clip envelope loop start and end points completely independent of meter grid.

Chapter 20

Working with Video

Live's flexible architecture makes it the perfect choice for scoring to video. You can trim video clips to select parts of them and use *Warp Markers* to visually align music in the Arrangement View with the video. You can then **render** your edited video file along with your audio.

Before diving in, you will want to be familiar with the concepts presented in the **Tempo Control and Warping** chapter.

If you are interested in syncing Live with external video equipment, you'll also want to read the chapter on **synchronization**.

20.1 Importing Video

Live can import movies in Apple QuickTime format (.mov) to be used as video clips. Movie files appear in Live's File Browser alongside audio files and Live Sets, and can be imported in the same way, by simply dragging them into the Live Set.

Note that Live will only display video for video clips residing in the Arrangement View. Movie files that are loaded into the Session View are treated as audio clips.

20.2 The Appearance of Video in Live

20.2.1 Video Clips in the Arrangement View

A video clip in the Arrangement View looks just like an audio clip, except for the “sprocket holes” in its title bar.

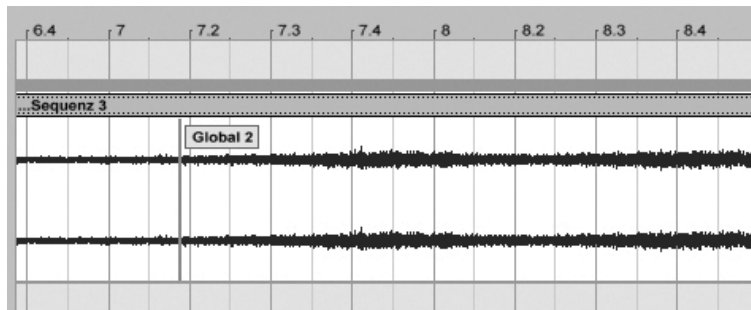

A Video Clip with a QuickTime Marker.

Live also displays a movie file’s QuickTime markers, if present, in the Arrangement View and Clip View. QuickTime markers are created by external video authoring applications, and although they cannot be selected or edited in any way by Live, they do provide visual cues that can be helpful when scoring. Note that these markers are always read from the original movie file, and are not stored in the Live Set or video clip.

For the most part, video clips in the Arrangement View are treated just like audio clips. They can be trimmed, for example, by dragging their right or left edges. However, there are some editing commands that, when applied to a video clip, will cause it to be replaced by an audio clip (which by definition has no video component). This replacement only occurs internally – your original movie files are never altered. The commands which will cause this are: *Consolidate*, *Reverse* and *Crop*.

20.2.2 The Video Window



The Video Window is a separate, floating window that always remains above Live's main window. It can be dragged to any location you like, and it will never get covered up by Live. You can toggle its visibility with a command in the View menu. The Video Window can be resized by dragging its bottom right-hand corner. The size and location of this window are not specific to the Set, and will be restored when you open a video again. The video can be shown in full screen (and optionally on a second monitor) by double-clicking in the Video Window. **Alt** (PC) / **Alt** (Mac) double-click in the Video Window to restore it to original size of the video.

Movies with Partial Tracks

In the QuickTime file format, the audio and video components do not have to span the entire length of a movie; gaps in playback are allowed. During gaps in video, Live's Video Window will display a black screen; gaps in audio will play silence.

20.2.3 Clip View

Soundtrack composers will want to note the Tempo Master option in Live's Clip View. When scoring to video, video clips are usually set as tempo masters, while audio clips are left as tempo slaves. These are, therefore, the default warp properties of clips in the Arrangement View. In this scenario, adding Warp Markers to a video clip defines "hit points" that the music will sync to. *Note that a video clip's Warp switch needs to be activated in order for the clip to be set as the tempo master.*

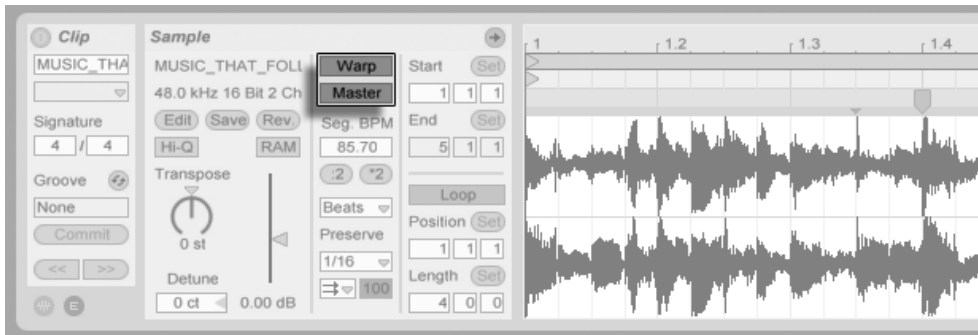

Setting a Video Clip as Tempo Master.

Remember from the [Tempo Control and Warping](#) chapter that, although any number of warped Arrangement clips can have the Tempo Master option activated, only the bottom-most, currently playing clip is the actual tempo master.

This also means that it is possible for video clips that are not the current tempo master to become warped, resulting in warped video output in the Video Window.



Warp Markers

While dragging a Warp Marker belonging to a video clip, you will notice that the Video Window updates to show the corresponding video frame, so that any point in the music can be easily aligned with any point in the video clip.

Since Live displays a movie file's embedded QuickTime markers, they can be used as convenient visual cues when setting Warp Markers.

20.3 Matching Sound to Video

In Live, it takes just a few steps to get started with video. Let's look at a common scenario – matching a piece of music to edits or hit points in a video:

1. Make sure that Live's Arrangement View is visible. Your computer keyboard's  key will toggle between the Session View and Arrangement View.
2. Drag a QuickTime movie from Live's File Browser and drop it into an audio track in the Arrangement View. The Video Window will appear to display the video component of the movie file. (Remember that you can move this window to any convenient location on the screen.)
3. Now that the video clip is loaded, drag an audio clip into the Arrangement View's drop area. A new track will automatically be created for it. Unfold both tracks so you can see their contents by clicking the  buttons to the left of their names.
4. Double-click on the video clip's title bar to view it in the Clip View. In the Sample box, make sure that the Warp button is enabled. Warped clips in the Arrangement View can be set as tempo master or slave. We want the Master/Slave switch set to *Master*, which will force the rest of the clips in the Live Set to adapt to the video clip's tempo (i.e., its normal playback rate).
5. Now add **Warp Markers** to the video clip, and adjust them to your liking. The locations of the Warp Markers define the synchronizing points between our music and our video. Notice how the video clip's waveform in the Arrangement View updates to reflect your changes as you make them.
6. If desired, enable the **Arrangement Loop** to focus on a specific section of the composition.
7. When you have finished, choose the Export Audio/Video command from Live's File menu. All of your audio will be mixed down and saved as a single audio file. You can also export your video file using this command.

20.4 Video Trimming Tricks

Commonly, composers receive movie files with a few seconds of blank space before the “real” beginning of the action. This pre-roll (“two-beep”) serves as a sync reference for the mixing engineer, who expects that the composer’s audio files will also include the same pre-roll. While working on music, however, the pre-roll is in the composer’s way: It would be more natural for the movie action to start at song time 1.1.1 and SMPTE time 00:00:00:00. This can be accommodated by trimming video clips, as follows.

First, we drop a movie file at the start of the Arrangement (1.1.1).



A Video Clip at the Start of the Arrangement.

Next, we double-click on the video clip’s title bar to display its contents in the Clip View. There, we drag the Start Marker to the right so the video clip starts at the beginning of the action.

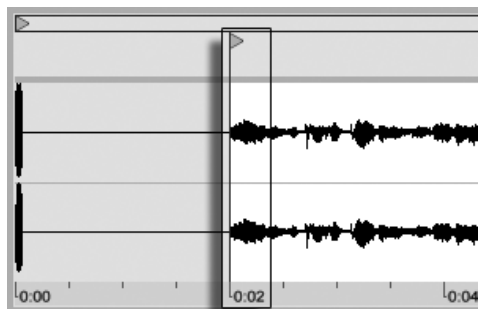

Dragging the Start Marker behind the Pre-Roll.

Now, both the action and the music to be composed start at 1.1.1 / 00.00.00.00. Once the music is done and ready to be **rendered to disk**, we need to bring back the pre-roll:

In the Arrangement View, we select all materials (Edit menu/Select All), then drag the entire composition a few seconds to the right:

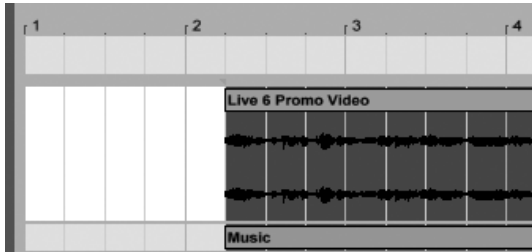

The Video Clip and the Final Clip of Music.

Now, we click on the video clip's title bar (to deselect everything else), then drag the video clip's left edge to the left as far as possible to reveal the pre-roll again.

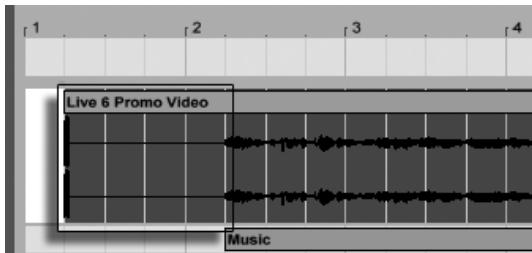

The Video Clip with Pre-Roll Restored.

The Export Audio/Video command, by default, creates sample files as long as the Arrangement selection; as the video clip is still selected, the exported sample file will have the exact same duration as the original movie file, including the pre-roll.

Chapter 21

Live Audio Effect Reference

Live comes with a selection of custom-designed, built-in audio effects. The [“Working with Instruments and Effects”](#) chapter explains the basics of using effects in Live.

21.1 Auto Filter

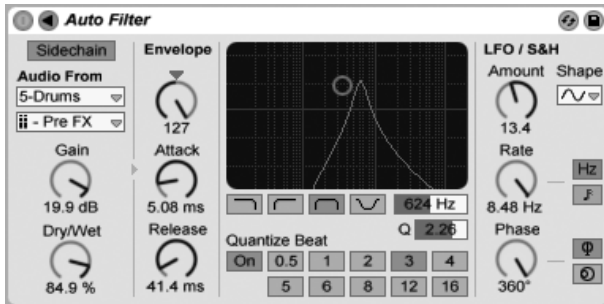

The Auto Filter Effect.

The Auto Filter effect provides classic analog filter emulation. It can be modulated by an envelope follower and/or an LFO to create moving filter effects. The envelope follower can track either the filtered signal or an external sidechain source.

There are four different filter types: lowpass, highpass, bandpass and notch. For each type, the X-Y controller adjusts frequency (to adjust, click and drag on the X-axis) and Q (also called resonance; to adjust, click and drag on the Y-axis). You can also click on the Freq and Q numeric displays and type in exact values.

Low Q values create a broad filter curve, while higher values introduce a narrow, resonant peak to the sound. With bandpass filtering, Q sets the bandwidth of the passed signal.

The Quantize Beat control applies quantized modulation to the filter frequency. With Quantize Beat off, frequency modulation follows the control source. Turning this feature on updates the filter modulation rhythmically with “stepped” changes that track the master tempo. The numbered buttons represent 16th notes, so, for example, selecting “4” as a beat value produces a modulation change once per beat.

The Envelope section controls how the envelope modulation affects the filter frequency. The Amount control defines the extent to which the envelope affects the filter frequency, while the Attack control sets how the envelope responds to rising input signals. Low Attack values cause a fast response to input levels; high values integrate any changes gradually, creating a looser, slower response. Think of it as adding inertia to the response.

Lower Release values cause the envelope to respond more quickly to falling input signals. Higher values extend the envelope’s decay.

Normally, the signal being filtered and the input source that triggers the envelope follower are the same signal. But by using *sidechaining*, it is possible to filter a signal based on the envelope of another signal. To access the Sidechain parameters, unfold the Auto Filter window by toggling the  button in its title bar.

Enabling this section with the Sidechain button allows you to select another track from the choosers below. This causes the selected track’s signal to trigger the filter’s envelope follower, instead of the signal that is actually being filtered.

The Gain knob adjusts the level of the external sidechain’s input, while the Dry/Wet knob allows you to use a combination of sidechain and original signal as the envelope follower’s trigger. With Dry/Wet at 100%, the envelope follower tracks the sidechain source exclusively. At 0%, the sidechain is effectively bypassed. Note that increasing the gain does *not* increase the volume of the source signal in the mix. The sidechain audio is only a trigger for the envelope follower and is never actually heard.

The Auto Filter also contains a Low Frequency Oscillator to modulate filter frequency in a

periodic fashion. The respective Amount control sets how much the LFO affects the filter. This can be used in conjunction with or instead of the envelope follower.

The Rate control specifies the LFO speed. It can be set in terms of hertz, or synced to the song tempo, allowing for controlled rhythmic filtering.

Available LFO waveform shapes are sine (creates smooth modulations with rounded peaks and valleys), square, triangle, sawtooth up, sawtooth down, and sample and hold (generates random positive and negative modulation values) in mono and stereo.

There are two LFOs, one for each stereo channel. The Phase and Offset controls define the relationship between these two LFOs.

Phase keeps both LFOs at the same frequency, but can set the two LFO waveforms “out of phase” with each other, creating stereo movement. Set to “180”, the LFO outputs are 180 degrees apart, so that when one LFO reaches its peak, the other is at its minimum.

Spin detunes the two LFO speeds relative to each other. Each stereo channel is modulated at a different frequency, as determined by the Spin amount.

For sample and hold, the Phase and Spin controls are not relevant and do not affect the sound. Instead, the Auto Filter offers two kinds of sample and hold: The upper sample and hold type available in the chooser provides independent random modulation generators for the left and right channels (stereo), while the lower one modulates both channels with the same signal (mono).

21.2 Auto Pan

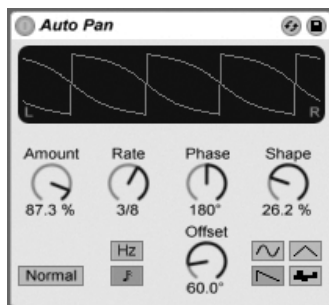

The Auto Pan Effect.

Auto Pan offers LFO-driven manipulation of amplitude and panning for creating automatic panning, tremolo and amplitude modulation, and beat-synchronized chopping effects.

Auto Pan's LFOs modulate the amplitude of the left and right stereo channels with sine, triangle, sawtooth down or random waveforms.

The Shape control pushes the waveform to its upper and lower limits, "hardening" its shape. The waveform can be set to "Normal" or "Invert" (use "Invert" to, for example, create the saw up waveform from the saw down waveform).

LFO speed is controlled with the Rate control, which can be set in terms of hertz. Rate can also be synced to the song tempo.

Though both LFOs run at the same frequency, the Phase control lends the sound stereo movement by offsetting their waveforms relative to each other. Set this to "180", and the LFOs will be perfectly out of phase (180 degrees apart), so that when one reaches its peak, the other is at its minimum. Phase is particularly effective for creating vibrato effects.

The Offset control shifts the start point of each LFO along its waveform.

The device's influence on incoming signals is set with the Amount control.

21.3 Beat Repeat

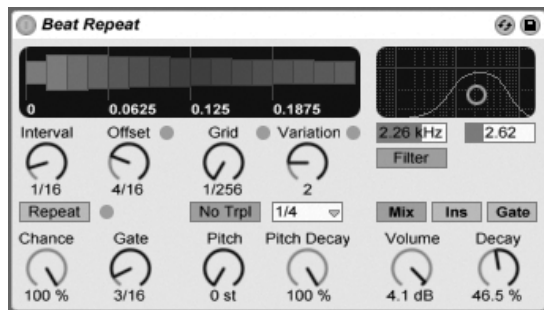

The Beat Repeat Effect.

Beat Repeat allows for the creation of controlled or randomized repetitions of an incoming signal.

The Interval control defines how often Beat Repeat captures new material and begins repeating it. Interval is synced to and set in terms of the song tempo, with values ranging from “1/32” to “4 Bars.” The Offset control shifts the point defined by Interval forward in time. If Interval is set to “1 Bar,” for example, and Offset to “8/16”, material will be captured for repetition once per bar on the third beat (i.e., halfway, or eight-sixteenths of the way, through the bar).

You can add randomness to the process using the Chance control, which defines the likelihood of repetitions actually taking place when Interval and Offset “ask” for them. If Chance is set to 100 percent, repetitions will always take place at the given Interval/Offset time; if set to zero, there will be no repetitions.

Gate defines the total length of all repetitions in sixteenth notes. If Gate is set to “4/16”, the repetitions will occur over the period of one beat, starting at the position defined by Interval and Offset.

Activating the Repeat button bypasses all of the above controls, immediately capturing material and repeating it until deactivated.

The Grid control defines the grid size – the size of each repeated slice. If set to “1/16”, a slice the size of one sixteenth note will be captured and repeated for the given Gate length (or until Repeat is deactivated). Large grid values create rhythmic loops, while small values create sonic artifacts. The No Triplets button sets grid division as binary.

Grid size can be changed randomly using the Variation control. If Variation is set to “0”, grid size is fixed. But when Variation is set to higher values, the grid fluctuates considerably around the set Grid value. Variation has several different modes, available in the chooser below: Trigger creates variations of the grid when repetitions are triggered; 1/4, 1/8 and 1/16 trigger variations in regular intervals; and Auto forces Beat Repeat to apply a new random variation after each repetition – the most complex form of grid variation in Beat Repeat (especially if triplets are also allowed).

Beat Repeat’s repetitions can be pitched down for special sonic effects. Pitch is adjusted through resampling in Beat Repeat, lengthening segments to pitch them down without again compressing them to adjust for the length change. This means that the rhythmical structure can become quite ambiguous with higher Pitch values. The Pitch Decay control tapers the pitch curve, making each repeated slice play lower than the previous one. *Warning:* This is the most obscure parameter of Beat Repeat.

Beat Repeat includes a combined lowpass and highpass filter for defining the passed frequency range of the device. You can turn the filter on and off, and set the center frequency and width of the passed frequency band, using the respective controls.

The original signal (which was received at Beat Repeat's input) is mixed with Beat Repeat's repetitions according to one of three mix modes: Mix allows the original signal to pass through the device and have repetitions added to it; Insert mutes the original signal when repetitions are playing but passes it otherwise; and Gate passes only the repetitions, never passing the original signal. Gate mode is especially useful when the effect is housed in a return track.

You can set the output level of the device using the Volume control, and apply Decay to create gradually fading repetitions.

21.4 Chorus

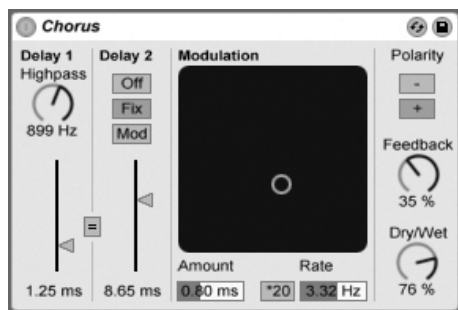

The Chorus Effect.

The Chorus effect uses two parallel time-modulated delays to create chorus (thickening) and flanging effects.

Each delay has its own delay time control, calibrated in milliseconds. Delay 1 has a highpass filter that can remove low frequencies from the delayed signal. Greater highpass values let only very high frequencies pass through to Delay 1.

Delay 2 can switch among three different modes. When off, only Delay 1 is audible. In Fix Mode, only Delay 1's delay time will be modulated. When Mod is activated, Delay 2 will receive the same modulation as Delay 1.

To set both delay lines to Delay 1's delay time, turn on the link button ("="). This is especially useful if you want to change both delays with a single gesture.



The Modulation X-Y controller can impart "motion" to the sounds. To change the modulation rate for the delay times, click and drag along the horizontal axis. To change the amount of modulation, click and drag along the vertical axis.

You can also make changes by entering parameter values in the Amount and Rate fields below the X-Y controller. The Amount value is in milliseconds, while the modulation frequency rate is in Hertz.

Clicking the *20 switch multiplies the modulation frequency by 20 to achieve more extreme sounds.

The Feedback control determines how much of the output signal feeds back into the input, while the Polarity switch sets (surprise!) the polarity. Polarity changes have the most effect with high amounts of feedback and short delay times.

The Dry/Wet control adjusts the balance between the processed and dry signals. Set it to 100 percent when using Chorus in a return track.

Enabling the Crisp option via the  (PC) /  (Mac) context menu can improve the sound quality, particularly at higher frequencies. This is enabled by default, except when loading Sets that use Chorus and were made in earlier versions of Live.

21.5 Compressor

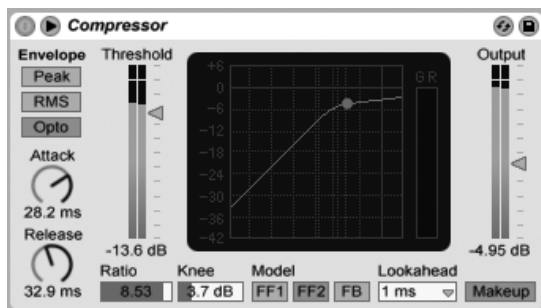

The Compressor Effect.

A compressor reduces gain for signals above a user-settable threshold. Compression reduces the levels of peaks, opening up more headroom and allowing the overall signal level to be turned up. This gives the signal a higher average level, resulting in a sound that is subjectively louder and “punchier” than an uncompressed signal.

The latest incarnation of the Compressor effect merges the functionality of the former Compressor I and Compressor II devices into a single unit, and adds additional functionality such as external sidechaining, adjustable knee, more EQ options, an improved peak mode, and a new feedback model, which is lovingly based on some classic hardware compressors. The new Compressor is fully backward-compatible with Compressor I and Compressor II presets.

A compressor’s two most important parameters are the Threshold and the compression Ratio:

The Threshold slider sets where compression begins. Signals above the threshold are attenuated by an amount specified by the Ratio parameter, which sets the ratio between the input and output signal. For example, with a compression ratio of 3, if a signal above the threshold increases by 3 dB, the compressor output will increase by only 1 dB. If a signal above the threshold increases by 6 dB, then the output will increase by only 2 dB. A ratio of 1 means no compression, regardless of the threshold.

The Knee control adjusts how gradually or abruptly compression occurs as the threshold is approached. With a setting of 0 dB, no compression is applied to signals below the threshold, and full compression is applied to any signal at or above the threshold. With very high ratios, this so-called “hard knee” behavior can sound harsh. With higher (or “soft”) knee values, the compressor begins compressing gradually as the threshold is approached. For example, with a 10 dB knee and a -20 dB threshold, subtle compression will begin at -30 dB and increase so that signals at -10 dB will be fully compressed.

The easiest way to visualize Compressor’s behavior is by observing how the graph changes when you adjust the threshold, ratio, and knee values. Input level is measured on the horizontal axis, while output level is represented vertically. Next to the graph is the Gain Reduction meter, which shows how much the gain is being reduced at any given moment. The more reduction, the more audible the effect; a gain reduction above 6 dB or so might produce the desired loudness, but significantly alters the sound and is easily capable of destroying its dynamic structure. This is something that cannot be undone in later production steps. Keep this in mind especially when using a compressor, limiter or sound loudness-

maximizing tool in the master channel. Less is often more here.

Because compression reduces the volume of loud signals and opens up headroom, you can use the Output slider so that the peaks once again hit the maximum available headroom. The Output meter shows the output signal's level. Enabling the Makeup button below the Output slider automatically compensates the output level if the threshold and ratio settings change.

The Attack and Release controls are essential parameters for controlling the response time of Compressor by defining how fast it reacts to input-level changes.

Attack defines how long it takes to reach maximum compression once a signal exceeds the threshold, while Release sets how long it takes for the compressor to return to normal operation after the signal falls below the threshold.

A slight amount of attack time (10–50 ms) allows peaks to come through unprocessed, which helps preserve dynamics by accentuating the initial portion of the signal. If these peaks cause overloads, you can try shortening the attack time, but extremely short times take the “life” out of the signal, and may lead to a slight “buzziness” caused by distortion. Short release times can cause “pumping” as the compressor tries to figure out whether to compress or not; while generally considered an undesirable effect, some engineers use it on full drum kits to give unusual “sucking” effects. Careful adjustment of attack and release times is essential when it comes to compression of rhythmical sources. If you are not used to working with compressors, play a drum loop and spend some time adjusting Attack, Release, Threshold and Gain. It can be very exciting!

A compressor can only react to an input signal once it occurs. Since it also needs to apply an attack/release envelope, the compression is always a bit too late. A digital compressor can solve this problem by simply delaying the input signal a little bit. Compressor offers three different Lookahead times: zero ms, one ms and ten ms. The results may sound pretty different depending on this setting.

Compressor can be used in three different EF (envelope follower) modes. With Peak selected, Compressor reacts to short peaks within a signal. RMS mode causes Compressor to be less sensitive to very short peaks and compress only when the incoming level has exceeded the threshold for a slightly longer time. Opto mode results in a non-linear release curve. Specifically, the release behavior is faster initially, and slows down as the gain reduction approaches zero. So which type should you use? There's no “right” answer, of course, but there are some common uses for each mode. Peak mode is more aggressive and pre-

cise, and so works well for limiting tasks where you need to ensure that there are absolutely no signals over the set threshold. RMS is closer to how people actually perceive loudness and is usually considered more “musical.” Opto mode, because of its non-linear release time is often considered “smooth” and natural sounding. Opto compressors are commonly used on vocals, bass and electric guitar. But as always, when it comes to compression, trust your ears and not the meters!

In addition to the EF modes, Compressor offers three Model types that offer further options for how the device measures and responds to signal levels. FF1 and FF2 are both “feed-forward” models, which analyze the loudness of the incoming signal. These are the models used in the former Compressor I and Compressor II devices, respectively. FB is a “feedback” model, which analyzes the output of the device and then self-adjusts its compression behavior. Because feedback compressors analyze signals that have already been compressed, their Attack and Release parameters are a bit less precise, and act more like “suggestions” to the compressor. But feedback compression generally results in a much “smoother” sound, with less overall gain reduction but also less potential for distortion artifacts. The classic analog compressor models that are so highly sought after in hardware-based studios are generally all feedback models. Note that, for reasons of quantum physics, Lookahead and external sidechaining are disabled when using the FB model; Ableton’s engineers are hard at work developing code that will allow our software to predict the future, but we don’t anticipate having this available until at least the next major release.

21.5.1 Sidechain Parameters

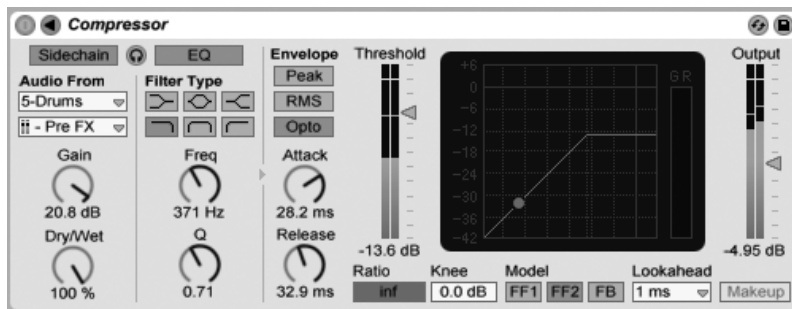

The Compressor Device With Sidechain Section.

Normally, the signal being compressed and the input source that triggers the compressor

are the same signal. But by using *sidechaining*, it is possible to compress a signal based on the level of another signal or a specific frequency component. To access the Sidechain parameters, unfold the Compressor window by toggling the  button in its title bar.

The sidechain parameters are divided into two sections. On the left are the external controls. Enabling this section with the Sidechain button allows you to select any of Live's **internal routing points** from the choosers below. This causes the selected source to act as the compressor's trigger, instead of the signal that is actually being compressed.

The Gain knob adjusts the level of the external sidechain's input, while the Dry/Wet knob allows you to use a combination of sidechain and original signal as the compressor's trigger. With Dry/Wet at 100%, the compressor is triggered entirely by the sidechain source. At 0%, the sidechain is effectively bypassed. Note that increasing the gain does *not* increase the volume of the source signal in the mix. The sidechain audio is only a trigger for the compressor and is never actually heard.

Note that FB mode and automatic Makeup are not available when using external sidechain.

On the right of the external section are the controls for the sidechain EQ. Enabling this section causes the compressor to be triggered by a specific band of frequencies, instead of a complete signal. These can either be frequencies in the compressed signal or, by using the EQ in conjunction with an external sidechain, frequencies in another track's audio.

The headphones button between the external and EQ sections allows you to listen to only the sidechain input, bypassing the compressor's output. Since the sidechain audio isn't fed to the output, and is only a trigger for the compressor, this temporary listening option can make it much easier to set sidechain parameters and hear what's actually making the compressor work.

21.5.2 Compression Tips

This section presents some tips for using Compressor effectively, particularly with the sidechain options.

Mixing a Voiceover

Sidechaining is commonly used for so-called “ducking” effects. For example, imagine that you have one track containing a voiceover and another track containing background music. Since you want the voiceover to always be the loudest source in the mix, the background music must get out of the way every time the narrator is speaking. To do this automatically, insert a Compressor on the music track, but select the narration track’s output as the external sidechain source.

Sidechaining in Dance Music

Sidechaining/ducking is a dance music producer’s secret weapon because it can help to ensure that basslines (or even whole mixes) always make room for the kick drum. By inserting a compressor on the bass (or master) track and using the kick drum’s track as the sidechain input, you can help to control problematic low frequencies that might interfere with the kick drum’s attack.

Using the sidechain EQ in conjunction with this technique can create ducking effects even if you only have a mixed drum track to work with (as opposed to an isolated kick drum). In this case, insert the Compressor on the track you want to duck. Then choose the drum track as the external sidechain source. Then enable the sidechain EQ and select the lowpass filter. By carefully adjusting the Frequency and Q settings, you should be able to isolate the kick drum from the rest of the drum mix. Using the sidechain listen mode can help you tune the EQ until you find settings you’re happy with.

Note that mastery of these techniques may result in a noticeable increase in drink tickets, remix offers and dates.

21.6 Corpus

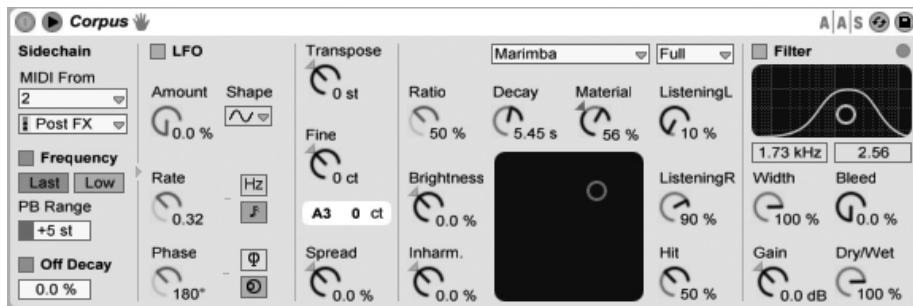

The Corpus Effect.

Corpus is an effect that simulates the acoustic characteristics of seven types of resonant objects. Developed in collaboration with Applied Acoustics Systems, Corpus uses physical modelling technology to provide a wide range of parameters and modulation options.

The full version of Corpus is not included with the standard version of Live, but is bundled with the [Collision](#) instrument as a special feature available for purchase separately.

The frequency and/or decay rate of the resonance can be MIDI modulated, by enabling the Frequency and/or Off Decay switches in the Sidechain section. The MIDI From choosers allow you to select the MIDI track and tapping point from which to receive MIDI note information.

With Frequency enabled, the tuning of the resonance is determined by the incoming MIDI note. If multiple notes are held simultaneously, the Last/Low switch determines whether the last or the lowest note will have priority.

The Transpose and Fine knobs allow for coarse and fine offset of the MIDI-modulated tuning. PB Range sets the range in semitones of pitch bend modulation. With Frequency disabled, the Tune control adjusts the base frequency of the resonance in Hertz. The corresponding MIDI note number and fine tuning offset in cents is displayed below.

Enabling Off Decay causes MIDI note off messages to mute the resonance. The slider below the switch determines the extent to which MIDI note off messages mute the resonance. At 0%, note offs are ignored, and the decay time is based only on the value of the Decay parameter, which is located under the Resonance Type selector. This is similar to how

real-world mallet instruments such as a marimbas and glockenspiels behave. At 100%, the resonance is muted immediately at note off, regardless of the Decay time.

You can hide or show the Sidechain parameters by toggling the  button in Corpus's title bar. This button will light up if the sidechain is active.

Corpus contains a Low Frequency Oscillator to modulate the resonant frequency. The Amount control sets how much the LFO affects the frequency.

The Rate control specifies the LFO speed. It can be set in terms of Hertz, or synced to the song tempo, allowing for controlled rhythmic modulation.

Available LFO waveform shapes are sine (creates smooth modulations with rounded peaks and valleys), square, triangle, sawtooth up, sawtooth down and two types of noise (stepped and smooth).

Although only one set of LFO controls is visible, there are actually two LFOs, one for each stereo channel. The Phase and Spin controls define the relationship between these two LFOs.

Phase (available only when the LFOs are synced to song tempo) keeps both LFOs at the same frequency, but can set the two LFO waveforms "out of phase" with each other, creating stereo movement. Set to "180", the LFO outputs are 180 degrees apart, so that when one LFO reaches its peak, the other is at its minimum. With Phase set to "360" or "0" the two LFOs run in sync.

Spin (only available when the LFOs are in Hertz mode) detunes the two LFO speeds relative to each other. Each stereo channel is modulated at a different frequency, as determined by the Spin amount.

For the noise waveforms, the Phase and Spin controls are not relevant and do not affect the sound.

Spread detunes the two resonators in relation to each other. Positive values raise the pitch of the left resonator while lowering the pitch of the right one, while negative values do the opposite. At 0%, the resonators are tuned the same.

The type chooser allows you to select from seven types of physically modeled resonant objects:

- *Beam* simulates the resonance properties of beams of different materials and sizes.

- *Marimba*, a specialized variant of the Beam model, reproduces the characteristic tuning of marimba bar overtones which are produced as a result of the deep arch-cut of the bars.
- *String* simulates the sound produced by strings of different materials and sizes.
- *Membrane* is a model of a rectangular membrane (such as a drum head) with a variable size and construction.
- *Plate* simulates sound production by a rectangular plate (a flat surface) of different materials and sizes.
- *Pipe* simulates a cylindrical tube that is fully open at one end and has a variable opening at the other (adjusted with the Opening parameter.)
- *Tube* simulates a cylindrical tube that is fully open at both ends.

The quality chooser controls the tradeoff between the sound quality of the resonators and performance by reducing the number of overtones that are calculated. “Basic” uses minimal CPU resources, while “Full” creates more sophisticated resonances. This parameter is not used with the Pipe or Tube resonators.

The Material knob adjusts the variation of the damping at different frequencies. At lower values, low frequency components decay slower than high frequency components (which simulates objects made of wood, nylon or rubber). At higher values, high frequency components decay slower (which simulates objects made of glass or metal). This parameter is not used with the Pipe or Tube resonators.

The Radius parameter is only available for the Pipe and Tube resonators. Radius adjusts the radius of the pipe or tube. As the radius increases, the decay time and high frequency sustain both increase. At very large sizes, the fundamental pitch of the resonator also changes.

The Decay and Material/Radius parameters can also be controlled with the X-Y controller.

Ratio is only available for the Membrane and Plate resonators, and adjusts the ratio of the object’s size along its x and y axes.

The Brightness control adjusts the amplitude of various frequency components. At higher values, higher frequencies are louder. This parameter is not used with the Pipe or Tube resonators.

Inharm. (Inharmonics) adjusts the pitch of the resonator's harmonics. At negative values, frequencies are compressed, increasing the amount of lower partials. At positive values, frequencies are stretched, increasing the amount of upper partials. This parameter is not used with the Pipe or Tube resonators.

Opening, which is only available for the Pipe resonator, scales between an open and closed pipe. At 0%, the pipe is fully closed on one side, while at 100% the pipe is open at both ends.

The Listening L and R controls adjust the location on the left and right resonator where the vibrations are measured. At 0%, the resonance is monitored at the object's center. Higher values move the listening point closer to the edge. These parameters are not used with the Pipe or Tube resonators, which are always measured in the middle of their permanently open end.

The Hit knob adjusts the location on the resonator at which the object is struck or otherwise activated. At 0%, the object is hit at its center. Higher values move the activation point closer to the edge. This parameter is not used with the Pipe or Tube resonators.

The processed signal is fed through a lowpass and highpass filter that can be controlled with an X-Y controller. To define the filter bandwidth, click and drag on the vertical axis. To set the position of the frequency band, click and drag on the horizontal axis. The filter can be toggled on or off with the Filter switch.

Width adjusts the stereo mix between the left and right resonators. At 0%, both resonators are fed equally to each side, resulting in mono output. At 100%, each resonator is sent exclusively to one channel.

Bleed mixes a portion of the unprocessed signal with the resonated signal. At higher values, more of the original signal is applied. This is useful for restoring high frequencies, which can often be damped when the tuning or quality are set to low values. This parameter is unavailable with the Pipe or Tube resonators.

Gain boosts or attenuates the level of the processed signal, while the Dry/Wet control adjusts the balance between the dry input signal and the signal sent to Corpus's processing. Turning Dry/Wet down will not cut resonances that are currently sounding, but rather stop new input signals from being processed.

Corpus contains a built-in limiter that automatically activates when the audio level is too high. This is indicated by the LED in the upper-right corner of Corpus's display.

21.7 Dynamic Tube

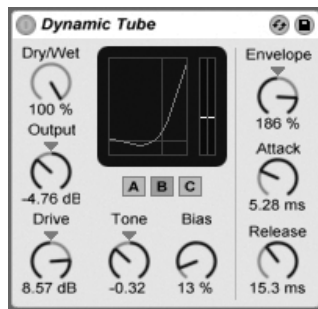

The Dynamic Tube Effect.

The Dynamic Tube effect infuses sounds with the peculiarities of tube saturation. An integrated envelope follower generates dynamic tonal variations related to the level of the input signal.

Three tube models, A, B and C, provide a range of distortion characteristics known from real amplifier tubes. Tube A does not produce distortions if Bias is set low, but will kick in whenever the input signal exceeds a certain threshold, creating bright harmonics. Tube C is a very poor tube amp that produces distortions all the time. The qualities of Tube B lie somewhere between these two extremes.

The Tone control sets the spectral distribution of the distortions, directing them into the higher registers, or through the midrange and deeper.



The Drive control determines how much signal reaches the tube; greater Drive yields a dirtier output. The intensity of the tube is controlled by the Bias dial, which pushes the signal into the celebrated realms of nonlinear distortion. With very high amounts of Bias, the signal will really start to break apart.

The Bias parameter can be positively or negatively modulated by an envelope follower, which is controlled with the Envelope knob. The more deeply the envelope is applied, the more the Bias point will be influenced by the level of the input signal. Negative Envelope values create expansion effects by reducing distortion on loud signals, while positive values will make loud sounds dirtier.

Attack and Release are envelope characteristics that define how quickly the envelope reacts

to volume changes in the input signal. Together, they shape the dynamic nature of the distortions. Note that if Envelope is set to zero, they will have no effect.

Cut or boost the device's final signal level with the Output dial.

Aliasing can be reduced by enabling Hi-Quality mode, which can be accessed via the  (PC) /   (Mac) context menu. This improves the sound quality, particularly with high frequency signals, but there is a slight increase in CPU usage.

21.8 EQ Eight

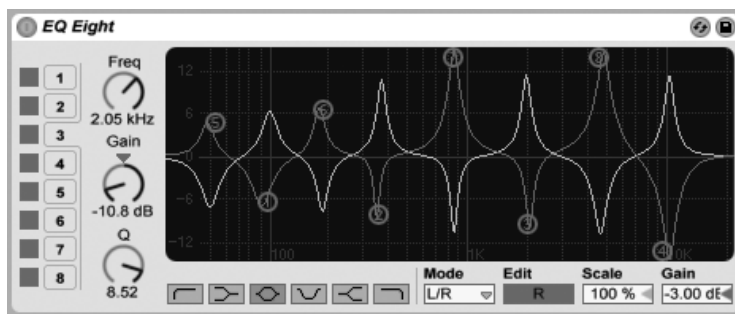

The EQ Eight Effect.

The EQ Eight effect is an equalizer featuring up to eight parametric filters per input channel, useful for changing a sound's timbre. It extends the functionality of the former EQ Four device, and is fully backward-compatible with EQ Four presets.

The input signal can be processed using one of three modes: Stereo, L/R and M/S. Stereo mode uses a single curve to filter both channels of a stereo input equally. L/R mode provides an independently adjustable filter curve for the left and right channels of a stereo input; M/S mode (Mid/Side) provides the same functionality for signals that have been recorded using M/S encoding.

When using the L/R and M/S modes, both curves are displayed simultaneously for reference, although only the active channel is editable. The Edit switch indicates the active channel, and is used to toggle between the two curves.

The filters can switch between six responses. From left to right in the display, these are:

- Low cut (cuts frequencies below the specified frequency);
- Low shelf (boosts or cuts frequencies lower than the specified frequency);
- Bell curve (boosts or cuts over a range of frequencies);
- Notch (sharply cuts frequencies within a narrow range);
- High shelf (boosts or cuts frequencies higher than the specified frequency);
- High cut (cuts frequencies above the specified frequency).

Each filter band can be turned on or off independently. Turn off bands that are not in use to save CPU power.

To edit the filter curve, click and drag on the filter dots in the display. Horizontal movement changes the filter frequency, while vertical movement adjusts the filter band's gain. To adjust the filter Q (also called resonance or bandwidth), hold down the **Alt** (PC) / **Alt** (Mac) modifier while dragging the mouse. Note that the gain cannot be adjusted for the low cut, notch and high cut filters. In these modes, vertical dragging adjusts the filter Q.

You can also use the numbered filter selector buttons to select a band for editing, and then edit parameter values with the Freq, Gain and Q dials (and/or type values into the number fields below each dial).

To achieve really drastic filtering effects, assign the same parameters to two or more filters.

As boosting will increase levels and cutting will decrease levels, use the global Gain field to optimize the output level for maximum level consistent with minimum distortion.

The Scale field will attenuate the gain of all filters that support gain (all except low cut, notch and high cut).

Enabling Hi-Quality mode via the **Q** (PC) / **Ctrl** (Mac) context menu can improve the sound quality, particularly with low frequency signals or when working at high sample rates. There is a slight increase in CPU usage in Hi-Quality mode.

21.9 EQ Three

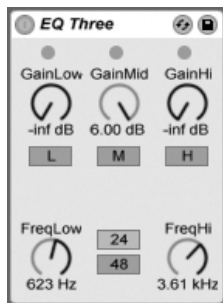

The EQ Three Effect.

If you have ever used a good DJ mixer you will know what this is: An EQ that allows you to adjust the level of low, mid and high frequencies independently.

Each band can be adjusted from -infinite dB to +6 dB using the gain controls. This means that you can completely remove, for example, the bass drum or bassline of a track, while leaving the other frequencies untouched.

You can also turn on or off each band using the On/Off buttons located under the gain controls. These buttons are especially handy if assigned to computer keys.

EQ Three gives you visual confirmation of the presence of a signal in each frequency band using three green LEDs. Even if a band is turned off, you can tell if there is something going on in it. The internal threshold for the LEDs is set to -24 dB.

The frequency range of each band is defined via two crossover controls: FreqLo and FreqHi. If FreqLo is set to 500 Hz and FreqHi to 2000 Hz, then the low band goes from 0 Hz to 500 Hz, the mid band from 500 Hz to 2000 Hz and the high band from 2000 Hz up to whatever your soundcard or sample rate supports.

A very important control is the 24 dB/48 dB switch. It defines how sharp the filters are cutting the signal at the crossover frequency. The higher setting results in more drastic filtering, but needs more CPU.

Note: The filters in this device are optimized to sound more like a good, powerful analog filter cascade than a clean digital filter. The 48 dB Mode especially does not provide a perfect linear transfer quality, resulting in a slight coloration of the input signal even if all

controls are set to 0.00 dB. This is typical behavior for this kind of filter, and is part of EQ Three's unique sound. If you need a more linear behavior choose 24 dB Mode or use the EQ Eight.

21.10 Erosion

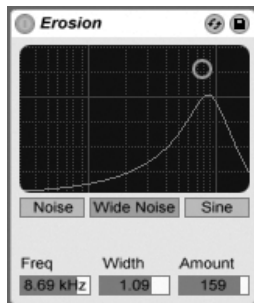

The Erosion Effect.

The Erosion effect degrades the input signal by modulating a short delay with filtered noise or a sine wave. This adds noisy artifacts or aliasing/downsampling-like distortions that sound very “digital.”

To change the sine wave frequency or noise band center frequency, click and drag along the X-axis in the X-Y field. The Y-axis controls the modulation amount. If you hold down the **Alt** (PC) / **Alt** (Mac) modifier key while clicking in the X-Y field, the Y-axis controls the bandwidth. Note that bandwidth is not adjustable when Sine is selected.

The Frequency control determines the color, or quality, of the distortion. If the Mode control is set to Noise, this works in conjunction with the Width control, which defines the noise bandwidth. Lower values lead to more selective distortion frequencies, while higher values affect the entire input signal. Width has no effect in Sine Mode.

Noise and Sine use a single modulation generator. However, Wide Noise has independent noise generators for the left and right channels, which creates a subtle stereo enhancement.

21.11 External Audio Effect

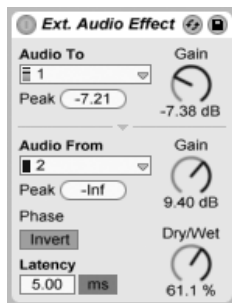

The External Audio Effect.

The External Audio Effect is a bit different than Live's other effects devices. Instead of processing audio itself, it allows you to use *external* (hardware) effects processors within a track's device chain.

The Audio To chooser selects the outputs on your computer's audio hardware that will go to your external device, while the Audio From chooser selects the inputs that will bring the processed signal back into Live. As with the [track inputs and outputs](#), the list of available inputs and outputs depends on the Audio Preferences, which can be reached via the "Configure..." option at the bottom of each chooser.

Below each chooser is a Peak level indicator that shows the highest audio level attained. Click on the indicators to reset them.

The Gain knobs next to the choosers adjust the levels going out of and back into Live. These levels should be set carefully to avoid clipping, both in your external hardware and when returning the audio to your computer.

The Dry/Wet control adjusts the balance between the processed and dry signals. Set it to 100 percent if using the External Audio Effect in a return track.

The Invert button inverts the phase of the processed signal coming back into Live.

Since hardware effects introduce latency that Live cannot automatically detect, you can manually compensate for any delays by adjusting the Latency slider. The button next to this slider allows you to set your latency compensation amount in either milliseconds or samples. If your external device connects to Live via a digital connection, you will want to adjust your

latency settings in samples, which ensures that the number of samples you specify will be retained even when changing the sample rate. If your external device connects to Live via an analog connection, you will want to adjust your latency settings in milliseconds, which ensures that the amount of time you specify will be retained when changing the sample rate. Note that adjusting in samples gives you finer control, so even in cases when you're working with analog devices, you may want to "fine tune" your latency in samples in order to achieve the lowest possible latency. In this case, be sure to switch back to milliseconds before changing your sample rate.

Note: If the **Delay Compensation** option is unchecked in the Options menu, the Latency slider is disabled.

For instructions on how to accurately set up latency compensation for your hardware, please see the "Driver Error Compensation" lesson.

21.12 Filter Delay

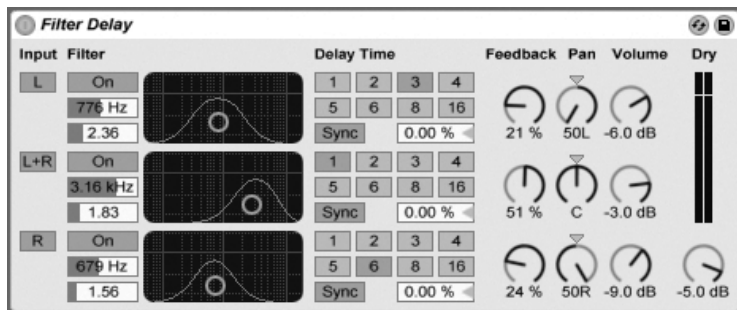

The Filter Delay Effect.

The Filter Delay provides three independent delay lines, each preceded by linked lowpass and highpass filters. This allows applying delay to only certain input signal frequencies, as determined by the filter settings. The feedback from each of the three delays is also routed back through the filters.

Each of the three delays can be switched on and off independently. The Filter Delay device assigns delay 1 to the input signal's left channel, delay 2 to the left and right channels and

delay 3 to the right channel. The Pan controls at the right can override the delay channels' outputs; otherwise each delay outputs on the channel from which it derives its input.

Each delay channel's filter has an associated On switch, located to the left of each X-Y controller. The X-Y controllers adjust the lowpass and highpass filters simultaneously for each delay. To edit filter bandwidth, click and drag on the vertical axis; click and drag on the horizontal axis to set the filter band's frequency.

To refer delay time to the song tempo, activate the Sync switch, which allows using the Delay Time beat division chooser. The numbered switches represent time delay in 16th notes. For example, selecting "4" delays the signal by four 16th notes, which equals one beat (a quarter note) of delay. With Sync Mode active, changing the Delay Time field percentage value shortens and extends delay times by fractional amounts, thus producing the "swing" type of timing effect found in drum machines.

If the Sync switch is off, the delay time reverts to milliseconds. In this case, to edit the delay time, click and drag up or down in the Delay Time field, or click in the field and type in a value.

The Feedback parameter sets how much of the output signal returns to the delay line input. Very high values can lead to runaway feedback and produce a loud oscillation – watch your ears and speakers if you decide to check out extreme feedback settings!

Each delay channel has its own volume control, which can be turned up to +12 dB to compensate for drastic filtering at the input.

The Dry control adjusts the unprocessed signal level. Set it to minimum if using Delay in a return track.

21.13 Flanger

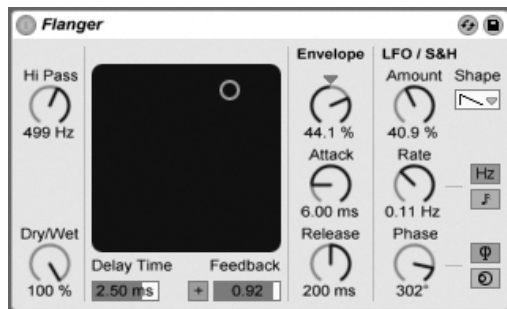

The Flanger Effect.

Flanger uses two parallel time-modulated delays to create flanging effects.

Flanger's delays can be adjusted with the Delay Time control. The Feedback control sends part of the output signal back through the device input, while the Polarity switch ("+" or "-") sets the polarity. Delay Time and Feedback can be changed simultaneously using the effect's X-Y controller.

Periodic control of delay time is possible using the envelope section. You can increase or decrease the envelope amount (or invert its shape with negative values), and then use the Attack and Release controls to define envelope shape.

Flanger contains two LFOs to modulate delay time for the left and right stereo channels. The LFOs have six possible waveform shapes: sine, square, triangle, sawtooth up, sawtooth down and random. The extent of LFO influence on the delays is set with the Amount control.



LFO speed is controlled with the Rate control, which can be set in terms of hertz. Rate can also be synced to the song tempo and set in meter subdivisions (e.g., sixteenth notes).

The Phase control lends the sound stereo movement by setting the LFOs to run at the same frequency, but offsetting their waveforms relative to each other. Set this to "180", and the LFOs will be perfectly out of phase (180 degrees apart), so that when one reaches its peak, the other is at its minimum.

Spin detunes the two LFO speeds relative to each other. Each delay is modulated at a different frequency, as determined by the Spin amount.

Adjusting the HiPass control will cut low frequencies from the delayed signal.

The Dry/Wet control adjusts the balance between the processed and dry signals. Set it to 100 percent if using Flanger in a return track.

Hi-Quality mode can be toggled on or off via a  (PC) /  (Mac) context menu entry. Enabling Hi-Quality results in a brighter sound, but there is a very slight increase in CPU usage.

21.14 Frequency Shifter



The Frequency Shifter Effect.

The Frequency Shifter moves the frequencies of incoming audio up or down by a user-specified amount in Hertz. Small amounts of shift can result in subtle tremolo or phasing effects, while large shifts can create dissonant, metallic sounds.

The Coarse and Fine knobs set the amount of shift that will be applied to the input. For example, if the input is a sine wave at 440 Hz and the frequency is set to 100 Hz, the output will be a sine wave at 540 Hz.

By changing the Mode from Shift to Ring, Frequency Shifter switches from classical frequency shifting to *ring modulation*. In Ring mode, the selected frequency amount is added to and subtracted from the input. For example, if the incoming audio signal (A) is a sine wave at 440 Hz and the Frequency is set to 100 Hz (B), the output will contain partials at 340 Hz (A-B) and 540 Hz (A+B).

The Drive button enables a distortion effect, while the slider below it controls the level of the distortion. Drive is only available in Ring mode.

Enabling the Wide button creates a stereo effect by inverting the polarity of the Spread value for the right channel. This means that increasing the Spread value will shift the frequency down in the right channel while shifting it up in the left. Note that Wide has no effect if the Spread value is set to 0.

Frequency Shifter contains two LFOs to modulate the frequency for the left and right stereo channels. The LFOs have six possible waveform shapes: sine, square, triangle, sawtooth up, sawtooth down and random. The extent of LFO influence on the frequency is set with the Amount control.

LFO speed is controlled with the Rate control, which can be set in terms of Hertz. Rate can also be synced to the song tempo and set in meter subdivisions (e.g., sixteenth notes).

The Phase control lends the sound stereo movement by setting the LFOs to run at the same frequency, but offsetting their waveforms relative to each other. Set this to "180", and the LFOs will be perfectly out of phase (180 degrees apart), so that when one reaches its peak, the other is at its minimum.

Spin detunes the two LFO speeds relative to each other. Each stereo channel is modulated at a different frequency, as determined by the Spin amount.

When using the random waveform, the Phase and Spin controls are not relevant and do not affect the sound.

The Dry/Wet control adjusts the balance between the processed and dry signals. This knob is called Mix when Drive is enabled. Note that the Drive effect is post-Mix, which means that you can use Frequency Shifter as a pure distortion effect by enabling Drive and setting Mix to 0%.

Frequency shifting is accomplished by simply adding or subtracting a value in Hertz to the incoming audio. This is distinct from *pitch shifting*, in which the ratios of the incoming frequencies (and thus their harmonic relationships) are preserved. For example, imagine you have an incoming audio signal consisting of sine waves an octave apart at 440 Hz and 880 Hz. To pitch shift this up an octave, we multiply these frequencies by two, resulting in new frequencies at 880 Hz and 1760 Hz.

21.14.1 Frequency Shifter Tips

Frequency shifting and ring modulation can produce some very interesting sounds. Here are some tips for using the Frequency Shifter device.

Drum tuning

Tuning sampled acoustic drums can be tricky. Using a sampler's transposition controls often changes the character of the sounds in unrealistic ways, resulting in "pinched" or "tubby" samples. Frequency shifting can be a useful alternative.

Try using the device in Shift mode with the Dry/Wet amount at 100%. Then adjust the Fine frequency no more than about 100 Hz up or down. This should change the apparent size and tuning of the drum while retaining the quality of the original sample.

Phasing

To create lush phasing effects, try using extremely small amounts of shift (no more than about 2 Hz). Note that the phasing is caused by the interaction of the processed and dry signals, so you won't hear an effect until you adjust the Dry/Wet balance so that both are audible; the strongest phasing will be heard when Dry/Wet is at 50%.

Tremolo

In Ring mode, frequencies below the audible range (about 20 Hz) create a tremolo effect. You can also impart a sense of stereo motion to the tremolo by turning on Wide and using small Spread values.

Learning more...

Try putting a [Spectrum](#) device after the Frequency Shifter to watch how the signal changes as you change parameters. To get a good overview of what's happening, try using a simple, continuous sine wave as your input.

21.15 Gate



The Gate Effect.

The Gate effect passes only signals whose level exceeds a user-specified threshold. A gate can eliminate low-level noise that occurs between sounds (e.g., hiss or hum), or shape a sound by turning up the threshold to where it cuts off reverb or delay tails or truncates an instrument's natural decay.

The Threshold slider sets the gate's sensitivity. If the gate is open and passing signal (i.e., the signal exceeds the gate threshold), the green LED lights.

The Attenuation slider, located beneath the Threshold fader, can attenuate signals below the threshold rather than just cutting them off. If set to $-\infty$ dB, a closed gate will mute the input signal. A setting of 0.00 dB means that even if the gate is closed, there is no effect on the signal. Settings in between these two extremes attenuate the input to a greater or lesser degree when the gate is closed.

With the Flip button enabled, the gate works in reverse; the signal will only pass if its level is *below* the threshold.

The Attack time determines how long it takes for the gate to switch from closed to open when a signal goes from below to above the threshold. Very short attack times can produce sharp clicking sounds, while long times soften the sound's attack.

When the signal goes from above to below the threshold, the Hold time kicks in. (Note to tech heads: the gate has hysteresis, so the release occurs about 3 dB lower than the threshold.) After the hold time expires, the gate closes over a period of time set by the Release parameter.

Normally, the signal being gated and the input source that triggers the gate are the same signal. But by using *sidechaining*, it is possible to gate a signal based on the level of another signal. To access the Sidechain parameters, unfold the Gate window by toggling the  button in its title bar.

Enabling this section with the Sidechain button allows you to select another track from the choosers below. This causes the selected track's signal to act as the gate's trigger, instead of the signal that is actually being gated.

The Gain knob adjusts the level of the external sidechain's input, while the Dry/Wet knob allows you to use a combination of sidechain and original signal as the gate's trigger. With Dry/Wet at 100%, the gate is triggered entirely by the sidechain source. At 0%, the sidechain is effectively bypassed. Note that increasing the gain does *not* increase the volume of the source signal in the mix. The sidechain audio is only a trigger for the gate and is never actually heard.

Sidechain gating can be used to superimpose rhythmic patterns from one source onto another. For example, a held pad sound can be triggered with the rhythm of a drum loop by inserting a Gate on the pad's track and choosing the drum loop's track as the sidechain input.

21.16 Grain Delay

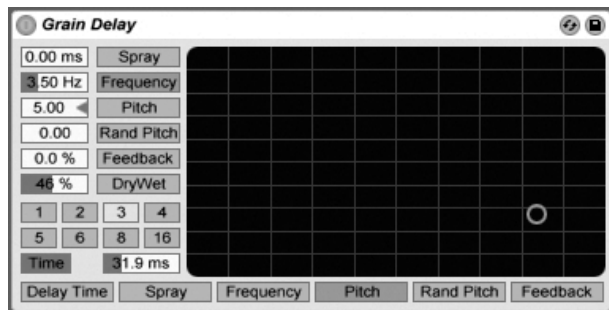

The Grain Delay Effect.

The Grain Delay effect slices the input signal into tiny particles (called “grains”) that are then individually delayed and can also have different pitches compared to the original signal

source. Randomizing pitch and delay time can create complex masses of sound and rhythm that seem to bear little relationship to the source. This can be very useful in creating new sounds and textures, as well as getting rid of unwelcome house guests, or terrifying small pets (just kidding!).

To refer delay time to the song tempo, activate the Sync switch, which allows using the Delay Time beat division chooser. The numbered switches represent time delay in 16th notes. For example, selecting "4" delays the signal by four 16th notes, which equals one beat (a quarter note) of delay. With Sync Mode active, changing the Delay Time field percentage value shortens and extends delay times by fractional amounts, thus producing the "swing" type of timing effect found in drum machines.

If the Sync switch is off, the delay time reverts to milliseconds. In this case, to edit the delay time, click and drag up or down in the Delay Time field, or click in the field and type in a value.

You can route each parameter to the X-Y controller's horizontal or vertical axis. To assign a parameter to the X-axis, choose it from the parameter row below the controller. To assign a parameter to the Y-axis, use the parameter row on the left side.

The Feedback parameter sets how much of the output signal returns to the delay line input. Very high values can lead to runaway feedback and produce a loud oscillation – watch your ears and speakers if you decide to check out extreme feedback settings!

You can transpose the grain pitch with the Pitch parameter, which acts much like a crude pitch shifter.

The Spray control adds random delay time changes. Low values smear the signal across time, which adds "noisiness" to the sound. High Spray values completely break down the structure of the source signal, introducing varying degrees of rhythmic chaos. This is the recommended setting for anarchists.

The Random Pitch control adds random variations to each grain's pitch. Low values create a sort of mutant chorusing effect, while high values can make the original source pitch completely unintelligible. This parameter can interact with the main Pitch control, thus allowing degrees of stability and instability in a sound's pitch structure.

The size and duration of each grain is a function of the Frequency parameter. The sound of Pitch and Spray depends very much on this parameter.

Grain Delay now also has a dry/wet control; it can be routed to the vertical axis of the X-Y controller.

21.17 Limiter

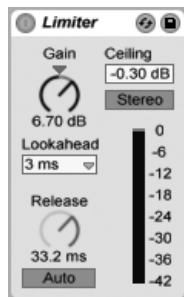

The Limiter Effect.

The Limiter effect is a mastering-quality dynamic range processor that ensures that the output does not exceed a specified level. Limiter is ideal for use in the Master track, to prevent clipping. A limiter is essentially a compressor with an infinite ratio. (For more information about compression theory, see the manual entry for the [Compressor device](#).)

The Gain knob allows you to boost or attenuate the incoming level before applying limiting.

Ceiling sets the absolute maximum level that the Limiter will output. If your incoming signal level has no peaks that are higher than the ceiling, Limiter will have no effect.

The Stereo / L/R switch determines how Limiter treats peaks that occur on only one side of the stereo signal. In L/R mode, Limiter functions as two separate limiters, with independent limiting for each channel. Stereo mode applies limiting to both channels whenever either of them has a peak that requires compression. L/R mode allows Limiter to apply more compression, but with some distortion of the stereo image.

The Lookahead chooser affects how quickly Limiter will respond to peaks that require compression. Shorter Lookahead times allow for more compression, but with an increase in distortion - particularly in the bass.

The Release knob adjusts how long it takes for Limiter to return to normal operation after the signal falls below the ceiling. With Auto enabled, Limiter analyzes the incoming signal

and sets an appropriate release time automatically.

The meter gives a visual indication of how much gain reduction is being applied to the signal.

Note that any devices or channel faders that appear after Limiter may add gain. To ensure that your final output will never clip, place Limiter as the last device in the Master track's device chain and keep your Master fader below 0 dB.

21.18 Looper

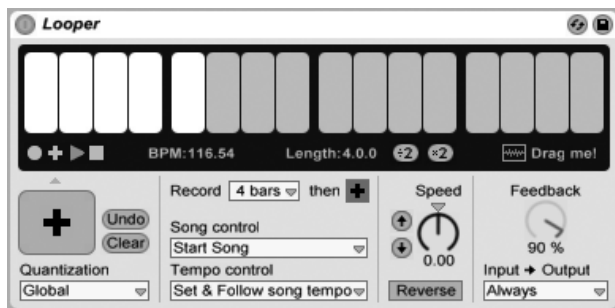

The Looper Effect.

Looper is an audio effect based on classic real-time looping devices. It allows you to record and loop audio, creating endless overdubs that are synced to your Set. If the Set is not playing, Looper can analyze incoming audio and set Live's tempo to match it. You can also predefine a loop length before recording and Live's tempo will adjust so that your loop fits into the specified number of bars. Furthermore, audio can be imported to Looper to create a background for newly overdubbed material, or exported from Looper as a new clip.

The top half of Looper's interface is a large display area optimized for easy readability during performance. During recording, the entire display area turns red. After recording, the display shows the current position in the loop and the total loop length in bars and beats.

Looper's transport buttons work in a similar way to other transport controls in Live. The Record button records incoming audio until another button is pressed. This overwrites any audio currently stored in Looper. Overdub continues to add additional layers of incoming

audio that are the length of the originally recorded material. The Play button plays back the current state of Looper's buffer without recording any new material. The Stop button stops playback.

The behavior of the transport controls changes depending on whether or not Live's playback is running. With the transport running, Looper behaves like a clip, and is subject to **launch quantization** as determined by the Quantization chooser. When Live's playback is stopped, Looper's transport engages immediately, regardless of the Quantization setting.

The Clear button erases Looper's buffer. If you press Clear in Overdub mode while the transport is running, the contents of the buffer are cleared but the tempo and length are maintained. Pressing Clear in any other mode resets the tempo and length.

The Undo button erases everything that you've overdubbed since the last time Overdub was enabled. Your original recording, and anything that was overdubbed in a previous pass, is preserved. After pressing Undo, the button changes to Redo, which replaces the material removed by the last undo.

The large button below the transport controls is the Multi-Purpose Transport Button. As with the normal transport buttons, this button's behavior changes depending on Looper's current playback state, and whether or not material has already been recorded. If the buffer is empty, a single click starts recording. If Looper is recording, overdubbing or stopped, a single click switches to play mode. During playback, a click switches to overdub mode, allowing you to toggle back and forth between overdub and playback via additional single clicks.

Quickly pressing the button twice stops Looper, from either play or overdub mode. Clicking and holding the button for two seconds while in play mode activates Undo or Redo. Pressing and holding for two seconds while stopped clears Looper's buffer.

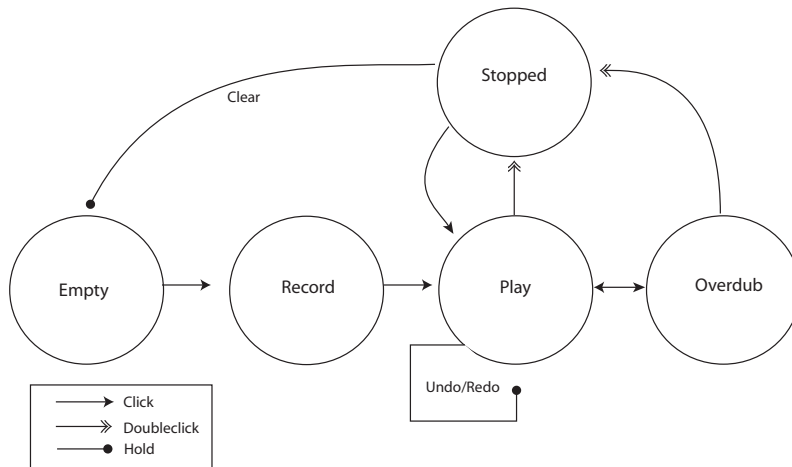

Diagram of Looper's Multi-Purpose Transport Button Behavior

Looper's Multi-Purpose Transport Button is optimized for use with a MIDI footswitch. To assign a footswitch, enter **MIDI Map Mode**, click the button and then press your attached footswitch. Then exit MIDI Map Mode.

The Tempo Control chooser affects how Looper determines the tempo of recorded material:

- *None*: Looper's internal tempo is independent of Live's global tempo.
- *Follow song tempo*: The speed of Looper's playback will be adjusted so that the recorded material plays back at Live's global tempo.
- *Set & Follow song tempo*: Live's global tempo will be adjusted to match the tempo of material recorded into Looper. Any subsequent changes to Live's global tempo will adjust the speed of Looper's playback so that the recorded material plays back at the new global tempo.

The Record Length chooser is used to set the length of recorded material. Its behavior changes depending on whether or not Live's global transport is running and, depending on the setting of the Tempo Control chooser, can set Live's global tempo:

- *Song running*: If Looper's Record Length chooser is set to the default "x bars," Looper will record until you press another transport button. If you specify a fixed number of bars to record by selecting another option in the chooser, Looper will record for the

specified time and then switch to Play or Overdub, as determined by the button next to this chooser.

- *Song not running*: If Looper's Record Length chooser is set to the default "x bars," Looper will make a guess about the tempo of the material you've recorded as soon as you press Overdub, Play or Stop. But this might result in a tempo that's twice or half as fast as you'd like. If you first specify a fixed number of bars, Looper's tempo will adjust so that your recording fits into this time.

The Song Control chooser determines how Looper's transport controls will affect Live's global transport:

- *None* means that Looper's transport controls have no effect on Live's global transport.
- *Start Song* will start Live's global transport whenever Looper enters Play or Overdub mode. Looper's Stop button has no effect on the global transport.
- *Start & Stop Song* locks Live's global transport to Looper's transport controls. Entering Play or Overdub mode will start Live's transport, while pressing Looper's Stop button will stop Live's transport.

The "*2" button doubles the length of Looper's recording buffer. Any material that you've already recorded will simply be duplicated. This allows you to, for example, record a series of one-bar ideas, and then overlay a series of two-bar ideas. The length and tempo of Looper's buffer is shown in the display area.

Similarly, the ":2" button cuts the length of the current buffer in half. The material in the currently playing half is kept, while the other half is discarded.

The "Drag me!" area in the display allows you to export Looper's buffer as a new audio file. You can drag and drop to the Browser or directly to a track, creating a new clip. The newly created clip's Warp mode will be set to **Re-Pitch** by default. You can also drag audio files to the "Drag me!" area, which will replace the contents of Looper's buffer. You can then use this material as a bed for further overdubs, for example.

The Speed knob adjusts Looper's playback speed (and thus pitch). The up and down arrow buttons to the left are shortcuts to raise or lower the pitch by octaves (thus doubling or halving the playback speed). These buttons are subject to the Quantization chooser setting.

Enabling the Reverse button plays the previously recorded material backwards. Any material that you overdub after enabling Reverse will be played forward. Note that disabling Reverse

will then swap this behavior; the original material will play forward again, while the material that was overdubbed while Reverse was enabled will play backwards. Engaging the Reverse button is subject to the Quantization chooser setting.

Feedback sets the amount of previously recorded signal that is fed back into Looper when overdubbing. When set to 100%, the previously recorded material will never decrease in volume. When set to 50%, it will be half as loud with each repetition. Any changes to the Feedback amount won't take effect until the next repetition. Note that Feedback has no effect in Play mode; each repetition will be at the same volume.

The Input -> Output chooser provides four options for monitoring Looper's input:

- *Always* allows the input signal to be heard regardless of Looper's playing or recording state. You'll typically want to choose Always when using Looper as an effect in a single track.
- *Never* means that the input signal will never be heard. You'll typically want to choose Never when using Looper as an effect in a return track, where it may be fed by send levels from a variety of other tracks.
- *Rec/OVR* means that the input is only audible when recording or overdubbing, but not when Looper is in Play mode or stopped. This is useful for situations in which you are feeding audio to multiple tracks, each containing its own Looper. If each of these Loopers is controlled with its own foot pedal, you can switch the recording and playback state while playing an instrument, without having to worry about monitor settings.
- *Rec/OVR/Stop* allows the input signal to be heard except when Looper is in play mode. This is similar to **Beat Repeat's** Insert mode, and can be used to record material that can suddenly interrupt your live playing.

21.18.1 Feedback Routing

Looper can be used as both a source and a target for **internal routing** to other tracks. This allows you to, for example, create Looper overdubs that continually feed back through another track's devices. To set this up:

1. Insert Looper on a track.

2. Record at least one pass of material into Looper.
3. Create another audio track.
4. In the new track's top Audio From and Audio To choosers, select the track containing the Looper.
5. In the new track's bottom Audio From and Audio To choosers, select "Insert-Looper."
6. Switch this track's Monitoring to "In."
7. Add additional effects devices to the device chain of the new track.
8. Put Looper into Overdub mode.

Looper's output will now be routed through the other track's device chain and then back into itself, creating increasingly processed overdub layers with each pass.

21.19 Multiband Dynamics

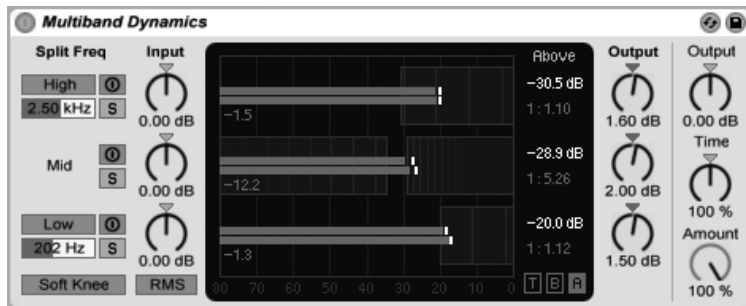

The Multiband Dynamics Effect.

The Multiband Dynamics device is a flexible tool for modifying the dynamic range of audio material. Designed primarily as a mastering processor, Multiband Dynamics allows for upward and downward compression and expansion of up to three independent frequency bands, with adjustable crossover points and envelope controls for each band. Each frequency range has both an upper and lower threshold, allowing for two types of dynamics processing to be used simultaneously per band.

21.19.1 Dynamics Processing Theory

To understand how to use the Multiband Dynamics device, it helps to understand the four different methods of manipulating dynamics.

When we use the term “compression,” we’re typically talking about lowering the level of signals that exceed a threshold. This is how Live’s **Compressor** works, and is more accurately called *downward compression* because it pushes loud signals down, thus reducing the dynamic range. But it is also possible to reduce a signal’s dynamic range by *raising* the levels of signals that are *below* a threshold. This much-less-common form of compression is called *upward compression*. As you can see from this diagram, employing either type of compression results in a signal with a smaller dynamic range than the original.

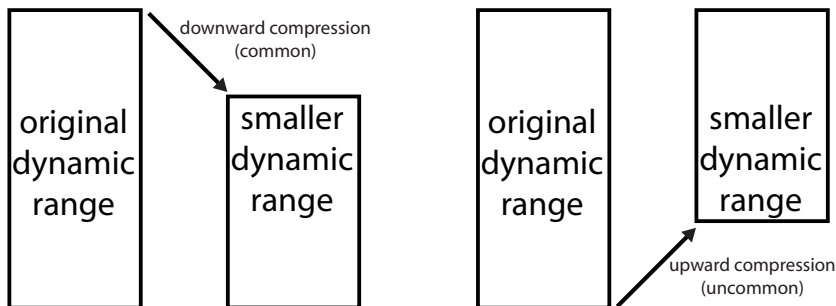

Downward and Upward Compression.

The opposite of compression is expansion. A typical expander lowers the levels of signals that are below a threshold. This is how Live’s **Gate** works, and is more accurately called *downward expansion* because it pushes quiet signals down, thus increasing the dynamic range. It is also possible to increase a signal’s dynamic range by *raising* the levels of signals that are *above* a threshold. Like upward compression, this technique is known as *upward expansion* and is much less common. This diagram shows that either type of expansion results in a signal with a larger dynamic range.

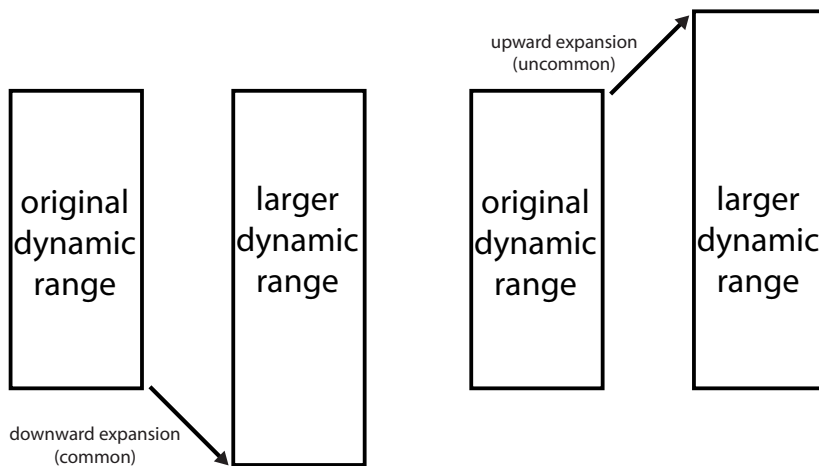

Downward and Upward Expansion.

To summarize:

- Downward compression (common): make loud signals quieter
- Upward compression (uncommon): make quiet signals louder
- Downward expansion (common): make quiet signals quieter
- Upward expansion (uncommon): make loud signals louder

The Multiband Dynamics device allows for all of these types of processing. In fact, because the device allows for incoming audio to be divided into three frequency bands, and each band has both an upper and lower threshold, a single instance of Multiband Dynamics can provide six types of dynamics processing simultaneously.



21.19.2 Interface and Controls



The High and Low buttons toggle the high and low bands on or off. With both bands off, the device functions as a single-band effect. In this case, only the Mid controls affect the incoming signal. The frequency sliders below the High and Low buttons adjust the crossovers that define the frequency ranges for each band. If the low frequency is set to 500 Hz and the high frequency is set to 2000 Hz, then the low band goes from 0 Hz to 500

Hz, the mid band from 500 Hz to 2000 Hz and the high band from 2000 Hz up to whatever your soundcard or sample rate supports.

Each band has activator and solo buttons. With the activator button disabled for a given band, its compression/expansion and gain controls are bypassed. Soloing a band mutes the others. The Input knobs boost or attenuate the level of each band before it undergoes dynamics processing, while the Output knobs to the right of the display adjust the levels of the bands after processing.

The display area provides a way of both visualizing your dynamics processing and adjusting the relevant compression and expansion behavior. For each band, the output level is represented by large bars, while the input level before processing is represented by small bars. With no processing applied, the input meters will be aligned with the top of the output meters. The scaling along the bottom of the display shows dB. As you adjust the gain or dynamics processing for a band, you can see how its output changes in comparison to its input.

As you move your mouse over the display, the cursor will change to a bracket as it passes over the edges of the blocks on the left or right side. These blocks represent the signal levels under the Below and over the Above thresholds, respectively. Dragging left or right on the edges of these blocks adjusts the threshold level. Holding down  while dragging a threshold will adjust the same threshold for all bands. Hold down  (PC) /  (Mac) to simultaneously adjust the Above and Below thresholds for a single band.

As you mouse over the middle of the block, the cursor will change to an up-down arrow. Click and drag up or down to make the signal within the selected volume range louder or quieter. Holding down  while dragging up or down will adjust the volume of the same block for all bands. Hold down  (PC) /  (Mac) to simultaneously adjust the Above and Below volumes for a single band. Double-clicking within the region resets the volume to its default.

In technical terms, lowering the volume in the block above the Above threshold applies downward compression, while raising it applies upward expansion. Likewise, lowering the volume in the block below the Below threshold applies downward expansion, while raising it applies upward compression. In all cases, you are adjusting the *ratio* of the compressor or expander.

The thresholds and ratios of all bands can also be adjusted via the column to the right of the display. The “T,” “B” and “A” buttons at the bottom right of the display area toggle

between displaying the Time (attack and release), Below (threshold and ratio) and Above (threshold and ratio) for each band.

For the Above thresholds, Attack defines how long it takes to reach maximum compression or expansion once a signal exceeds the threshold, while Release sets how long it takes for the device to return to normal operation after the signal falls below the threshold.

For the Below thresholds, Attack defines how long it takes to reach maximum compression or expansion once a signal drops below the threshold, while Release sets how long it takes for the device to return to normal operation after the signal goes above the threshold.

With Soft Knee enabled, compression or expansion begins gradually as the threshold is approached.

The RMS/Peak switch also affects how quickly Multiband Dynamics responds to level changes. With Peak selected, the device reacts to short peaks within a signal. RMS mode causes it to be less sensitive to very short peaks and to begin processing only when the incoming level has crossed the threshold for a slightly longer time.

The global Output knob adjusts the overall output gain of the device.

The Time control scales the durations of all of the Attack and Release controls. This allows you to maintain the same relative envelope times, but make them all faster or slower by the same amount.

The Amount knob adjusts the intensity of the compression or expansion applied to all bands. At 0%, each compressor/expander has an effective ratio of 1, meaning that it has no effect on the signal.

21.19.3 Multiband Dynamics Tips

Multiband Dynamics is a feature-rich and powerful device, capable of up to six independent types of simultaneous processing. Because of this, getting started can be a bit intimidating. Here are some real-world applications to give you some ideas.

Basic Multiband Compression

By using only the upper thresholds, Multiband Dynamics can be used as a traditional “downward” compressor. Adjust the crossover points to suit your audio material, then apply downward compression (by dragging down in the upper blocks in the display or by setting the numerical ratios to values greater than 1.)

De-essing

To remove “harshness” caused by overly loud high frequency content, try enabling only the upper band and setting its crossover frequency to around 5 kHz. Then gradually adjust the threshold and ratio to apply subtle downward compression. It may help to solo the band to more easily hear the results of your adjustments. Generally, de-essing works best with fairly fast attack and release times.

Uncompression

Mastering engineers are often asked to perform miracles, like adding punch and energy to a mix that has already been heavily compressed, and thus has almost no remaining transients. Most of the time, these mixes have also been heavily maximized, meaning that they also have no remaining headroom. Luckily, upward expansion can sometimes help add life back to such overly squashed material. To do this:

- Turn down the Input knob to provide some additional headroom.
- Adjust the Above thresholds for the bands so that they’re below the highest peaks.
- Add a small amount of upward expansion to each band. Be careful - excessive upward expansion can make transients very loud.
- Carefully adjust the attack and release times for each band. Note that, unlike in typical downward compression, very fast attack times will *increase* the impact of transients, while slower times result in a more muffled sound.

Note: Adding a maximizer or limiter to boost gain after you’ve returned some peaks to your material may simply destroy them again.

21.20 Overdrive

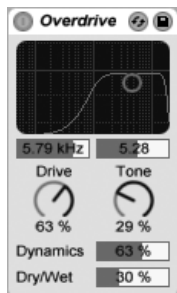

The Overdrive Effect.

Overdrive is a distortion effect that pays homage to some classic pedal devices commonly used by guitarists. Unlike many distortion units, it can be driven extremely hard without sacrificing dynamic range.

The distortion stage is preceded by a bandpass filter that can be controlled with an X-Y controller. To define the filter bandwidth, click and drag on the vertical axis. To set the position of the frequency band, click and drag on the horizontal axis. These parameters can also be set via the slider boxes below the X-Y display.

The Drive control sets the amount of distortion. Note that 0% does *not* mean zero distortion!

Tone acts as a post-distortion EQ control. At higher values, the signal has more high-frequency content.

The Dynamics slider allows you to adjust how much compression is applied as the distortion is increased. At low settings, higher distortion amounts result in an increase in internal compression and make-up gain. At higher settings, less compression is applied.

The Dry/Wet control adjusts the balance between the processed and dry signals. Set it to 100 percent if using Overdrive in a return track.

21.21 Phaser

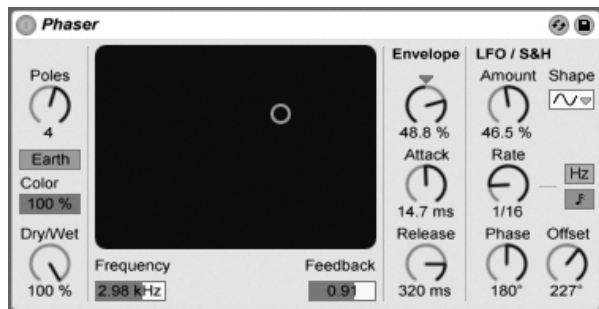

The Phaser Effect.

Phaser uses a series of all-pass filters to create a phase shift in the frequency spectrum of a sound.

The Poles control creates notches in the frequency spectrum. The Feedback control can then be used to invert the waveform and convert these notches into peaks (or poles). Filter cutoff frequency is changed with the Frequency control, which can be adjusted in tandem with Feedback using the effect's X-Y controller.

The device has two modes, Space and Earth, for changing the spacing of notches along the spectrum, and hence the "color" of the sound. This effect can be further adjusted with the Color control.

Periodic control of the filter frequency is possible using the envelope section. You can increase or decrease the envelope amount (or invert its shape with negative values), and then use the Attack and Release controls to define envelope shape.

Phaser contains two LFOs to modulate filter frequency for the left and right stereo channels. The LFOs have six possible waveform shapes: sine, square, triangle, sawtooth up, sawtooth down and random. The extent of LFO influence on the filter frequency is set with the Amount control.

LFO speed is controlled with the Rate control, which can be set in terms of hertz. Rate can also be synced to the song tempo and set in meter subdivisions (e.g., sixteenth notes).

The Phase control lends the sound stereo movement by setting the LFOs to run at the same frequency, but offsetting their waveforms relative to each other. Set this to "180", and the

LFOs will be perfectly out of phase (180 degrees apart), so that when one reaches its peak, the other is at its minimum.

Spin detunes the two LFO speeds relative to each other. Each filter frequency is then modulated using a different LFO frequency, as determined by the Spin amount.

The Dry/Wet control adjusts the balance between the processed and dry signals. Set it to 100 percent if using Phaser in a return track.

21.22 Ping Pong Delay

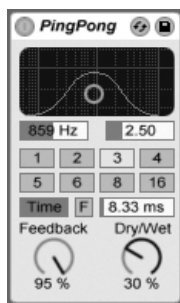

The Ping Pong Delay Effect.

The Ping Pong Delay effect uses a single tapped delay line to create a delay that jumps from the left to the right output.

The delay is preceded by a lowpass and highpass filter that can be controlled with an X-Y controller. To define the filter bandwidth, click and drag on the vertical axis. To set the position of the frequency band, click and drag on the horizontal axis.

To refer delay time to the song tempo, activate the Sync switch, which allows using the Delay Time beat division chooser. The numbered switches represent time delay in 16th notes. For example, selecting “4” delays the signal by four 16th notes, which equals one beat (a quarter note) of delay. This delay time represents the time it takes for the input signal to appear at the left channel. The delay time between the input and the right channel is twice as long.



If the Sync switch is off, the delay time reverts to milliseconds. In this case, to edit the delay

time, click and drag up or down in the Delay Time field, or click in the field and type in a value.

The Feedback parameter controls how much of the right channel output signal returns to the delay line input. The feedback loop also includes a filter that can color the feedback sound, thus producing different timbres with successive echoes.

The Freeze button, labeled “F”, will cause the delay to endlessly cycle the audio which is in its buffer at the moment that the button is pressed, ignoring any new input until Freeze is disabled.

The Dry/Wet control adjusts the balance between the processed and dry signals. Set it to 100 percent if using Ping Pong Delay in a return track.

Changing the delay time while Ping Pong Delay is processing audio can cause abrupt changes in the sound of the delayed signal. You can choose between three delay transition modes via the  (PC) /  (Mac) context menu of the device's title bar:

- *Repitch* causes a pitch variation when changing the delay time, similar to the behavior of old hardware delay units.
- *Fade* creates a crossfade between the old and new delay times. This sounds similar to time stretching if the delay time is gradually changed. Fade mode is the default option.
- *Jump* immediately jumps to the new delay time. Note that this will cause an audible click if the delay time is changed while delays are sounding. Jump mode corresponds to the default behavior prior to Live 8. When loading Sets that were made in earlier versions, Jump will be selected automatically.

21.23 Redux



The Redux Effect.

Nostalgic for the famed low-resolution sound quality of the Ensoniq Mirage, Fairlight CMI or Commodore-64 computer? Redux returns us to the Dark Ages of digital by reducing a signal's sample rate and bit resolution.

The Downsample section has two parameters: "Downsample" and a downsample Mode switch.

If the downsample dial is set to "1", every input sample passes to the output and the signal does not change. If set to "2", only every second sample will be processed, so the result sounds a bit more "digital." The higher the number, the lower the resulting sample rate, and the more "deconstructed" the sound. Downsampling is like applying a mosaic effect to an image: There's a loss of information and sharp edges occur between the blocks.

The Downsample Mode switch defines if the downsampling either interpolates over a smaller range ("soft," down to 20.0 samples) or does not interpolate over a larger range ("hard," down to 200 samples).

Bit Reduction is similar, but while downsampling superimposes a grid in time, bit reduction does the same for amplitude.

If the Bit Reduction amplitude dial is set to 8, amplitude levels are quantized to 256 steps (8 bit resolution). If set to 1, the result is pretty brutal: Each sample contains either a full positive or full negative signal, with nothing in between.

Bit Reduction defines an input signal of 0dB as 16 bit. Signals above 0dB are clipped, and the red overload LED will light up.

Turning off Bit Reduction results in modest CPU savings.

21.24 Resonators

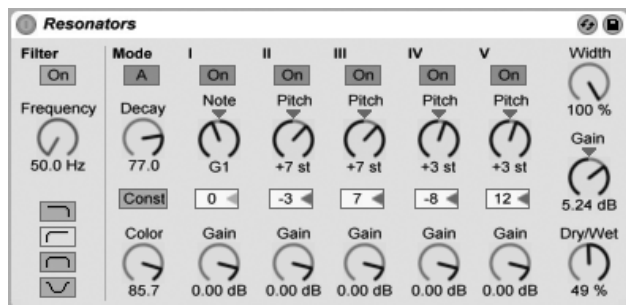

The Resonators Effect.

This device consists of five parallel resonators that superimpose a tonal character on the input source. It can produce sounds resembling anything from plucked strings to vocoder-like effects. The resonators are tuned in semitones, providing a musical way of adjusting them. The first resonator defines the root pitch and the four others are tuned relative to this pitch in musical intervals.

The input signal passes first through a filter, and then into the resonators. There are four input filter types to select from: lowpass, bandpass, highpass and notch. The input filter frequency can be adjusted with the Frequency parameter.

The first resonator is fed with both the left and right input channels, while the second and fourth resonators are dedicated to the left channel, and the third and fifth to the right channel.

The Note parameter defines the root pitch of all the resonators ranging from C1 to C5. It can also be detuned in cents using the Fine parameter. The Decay parameter lets you adjust the amount of time it takes for the resonators to be silent after getting an input signal. The longer the decay time, the more tonal the result will be, similar to the behavior of an undamped piano string. As with a real string, the decay time depends on the pitch, so low notes will last longer than higher ones. The Const switch holds the decay time constant regardless of the actual pitch.

Resonators provides two different resonance modes. Mode A provides a more realistic sounding resonance, while Mode B offers an effect that is especially interesting when Resonator I's Note parameter is set to lower pitches.

The brightness of the resulting sound can be adjusted using the Color control.

All of the resonators have an On/Off switch and a Gain control. A resonator that is turned off does not need CPU. Turning off the first resonator does not affect the other ones.

Resonators II through V follow the Note parameter defined in Resonator I, but they can each be individually transposed +/- 24 semitones using the Pitch controls and detuned in cents using the Detune controls.

The output section features the obligatory Dry/Wet control and a Width parameter that affects only the wet signal and blends the left and right outputs of Resonators II-V into a mono signal if set to zero.

21.25 Reverb

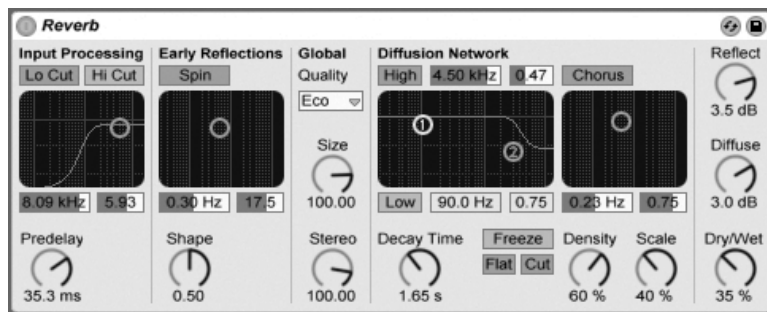

The Reverb Effect.

21.25.1 Input Processing

The input signal passes first through high and low cut filters, whose X-Y controller allows changing the band's center frequency (X-axis) and bandwidth (Y-axis). Either filter may be switched off when not needed to save CPU power.

Predelay controls the delay time, in milliseconds, before the onset of the first early reflection. This delays the reverberation relative to the input signal. One's impression of the size of a real room depends partly on this delay. Typical values for "natural" sounds range from 1ms to 25ms.

21.25.2 Early Reflections

These are the earliest echoes that you hear after they bounce off a room's walls, before the onset of the diffused reverberation "tail." Their amplitude and distribution give an impression of the room's character.

The Shape control "sculpts" the prominence of the early reflections, as well as their overlap with the diffused sound. With small values, the reflections decay more gradually and the diffused sound occurs sooner, leading to a larger overlap between these components. With large values, the reflections decay more rapidly and the diffused onset occurs later. A higher value can sometimes improve the source's intelligibility, while a lower value may give a smoother decay.

Spin applies modulation to the early reflections. The X-Y control accesses the depth and frequency of these modulations. A larger depth tends to provide a less-colored (more spectrally neutral) late diffusion response. If the modulation frequency is too high, doppler frequency shifting of the source sound will occur, along with surreal panning effects. Spin may be turned off, using the associated switch, for modest CPU savings.

21.25.3 Global Settings

The Quality chooser controls the tradeoff between reverb quality and performance. "Eco" uses minimal CPU resources, while "High" delivers the richest reverberation.

The Size parameter controls the "room's" volume. At one extreme, a very large size will lend a shifting, diffused delay effect to the reverb. The other extreme – a very small value – will give it a highly colored, metallic feel.

The Stereo Image control determines the width of the output's stereo image. At the highest setting of 120 degrees, each ear receives a reverberant channel that is independent of the

other (this is also a property of the diffusion in real rooms). The lowest setting mixes the output signal to mono.

21.25.4 Diffusion Network

The Diffusion network creates the reverberant tail that follows the early reflections. The decay time control adjusts the time required for this tail to drop to 1/1000th (-60 dB) of its initial amplitude.

High and low shelving filters provide frequency-dependent reverberation decay. The high-frequency decay models the absorption of sound energy due to air, walls and other materials in the room (people, carpeting and so forth). The low shelf provides a thinner decay. Each filter may be turned off to save CPU consumption.

The Freeze control freezes the diffuse response of the input sound. When on, the reverberation will sustain almost endlessly. Cut modifies Freeze by preventing the input signal from adding to the frozen reverberation; when off, the input signal will contribute to the diffused amplitude. Flat bypasses the high and low shelf filters when freeze is on. If Flat is off, the frozen reverberation will lose energy in the attenuated frequency bands, depending on the state of the high and low shelving filters.

The Echo Density and Scale parameters provide additional control over the diffusion's density and coarseness, and, when the room size is extremely small, have a large impact on the coloration contributed by the diffusion.

The Chorus section adds a little modulation and motion to the diffusion. Like the Spin section, you can control the modulation frequency and amplitude, or turn it off.

21.25.5 Output

At the reverb output, you can adjust the effect's overall Dry/Wet mix, and vary the amplitude of reflections and diffusion with the Reflect Level and Diffuse Level controls.

21.26 Saturator

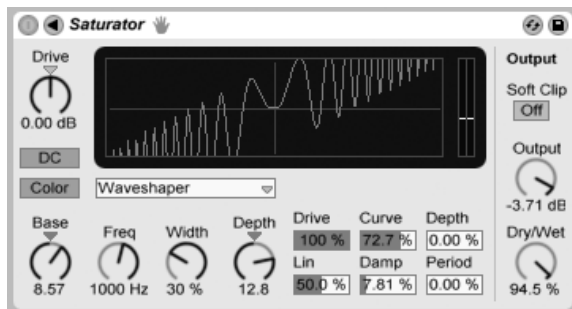

The Saturator Effect.

Saturator is a waveshaping effect that can add that missing dirt, punch or warmth to your sound. It can coat input signals with a soft saturation or drive them into many different flavors of distortion.

An X-Y grid helps to visualize Saturator's shaping curve. The shaper's input and output values are mapped to the X and Y axes, respectively. The curve defines the transfer function, which is the extent to which output values fluctuate in relation to input values. Because this is usually a nonlinear process, the incoming signal is reshaped to a greater or lesser degree depending upon its level at each moment in time.

Incoming signals are first clipped to the dB level set by the Drive control. The meter on the right side of the display shows how much Saturator is influencing the signal.

Signal shaping has six fixed modes: Analog Clip, Soft Sine, Medium Curve, Hard Curve, Sinoid Fold and Digital Clip. There is also the flexible Waveshaper mode, featuring six adjustable waveshaping parameters.

In the Analog Clip and Digital Clip modes, the signal is clipped completely and immediately. Soft Sine, Medium Curve and Hard Curve modes soften signal clipping to varying degrees. Sinoid Fold mode can be good for special effects.

The most dramatic effects can be created by selecting the *Waveshaper* curve, which has its own dedicated set of controls. To access these six parameter fields, unfold the Saturator window by toggling the  button in its title bar.

The Waveshaper mode's six additional parameters are: Drive, Lin, Curve, Damp, Depth and

Period.



- *Drive* determines how much the input signal will be influenced by the *Waveshaper* parameters. Setting *Drive* to zero will negate the effect entirely.
- *Lin* works together with the *Curve* and *Depth* parameters to alter the linear portion of the shaping curve.
- *Curve* adds mostly third-order harmonics to the input signal.
- *Damp* flattens any signal near the grid's origin. It behaves like an ultra-fast noise gate.
- *Depth* controls the amplitude of a sine wave that is superimposed onto the distortion curve.
- *Period* determines the density of ripples in the superimposed sine wave.

The DC button activates a DC filter at Saturator's input stage. This is mainly useful for removing DC offsets from audio material that contains them.

Activating the Color button enables two filters. The first of these, controlled with the Base control, dictates how much the effect will be reduced or increased for very low frequencies. The second filter, essentially an equalizer, is used for controlling higher frequencies. It is shaped with the Freq (cutoff frequency), Width and Depth controls.

The Output control attenuates the level at the device output. When the Soft Clip switch is activated, Saturator will also apply an instance of its "Analog Clip" curve to the output.

The Dry/Wet control adjusts the balance between the processed and dry signals. Set it to 100 percent when using Saturator in a return track.

Aliasing can be reduced by enabling Hi-Quality mode, which can be accessed via the  (PC) /  (Mac) context menu. This improves the sound quality, particularly with high frequency signals, but there is a slight increase in CPU usage.

21.27 Simple Delay

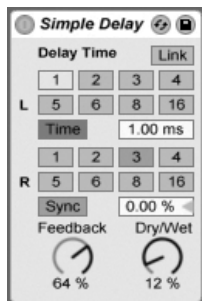

The Simple Delay Effect.

The Simple Delay provides two independent delay lines, one for each channel (left and right).

To refer delay time to the song tempo, activate the Sync switch, which allows using the Delay Time beat division chooser. The numbered switches represent time delay in 16th notes. For example, selecting “4” delays the signal by four 16th notes, which equals one beat (a quarter note) of delay.

If the Sync switch is off, the delay time reverts to milliseconds. In this case, to edit the delay time, click and drag up or down in the Delay Time field, or click in the field and type in a value.

The Feedback parameter defines how much of each channel’s output signal feeds back into the delay lines’ inputs. Internally, they are two independent feedback loops, so a signal on the left channel does not feed back into the right channel and vice versa.

The Dry/Wet control adjusts the balance between the processed and dry signals. Set it to 100 percent when using Simple Delay in a return track.

Changing the delay time while Simple Delay is processing audio can cause abrupt changes in the sound of the delayed signal. You can choose between three delay transition modes via the (PC) / (Mac) context menu of the device’s title bar:

- *Repitch* causes a pitch variation when changing the delay time, similar to the behavior of old hardware delay units.

- *Fade* creates a crossfade between the old and new delay times. This sounds similar to time stretching if the delay time is gradually changed. Fade mode is the default option.
- *Jump* immediately jumps to the new delay time. Note that this will cause an audible click if the delay time is changed while delays are sounding. Jump mode corresponds to the default behavior prior to Live 8. When loading Sets that were made in earlier versions, Jump will be selected automatically.

21.28 Spectrum

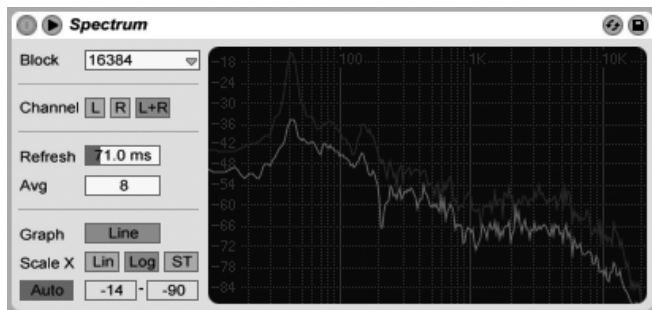

The Spectrum Device.

Spectrum performs realtime frequency analysis of incoming audio signals. The results are represented in a graph, with dB along the vertical axis and frequency/pitch along the horizontal. The peak levels are retained on the graph until the song is restarted. Note that Spectrum is not an audio effect, but rather a measurement tool - it does not alter the incoming signal in any way.

The Block chooser selects the number of samples that will be analyzed in each measurement. Higher values result in better accuracy, but at the expense of increased CPU load.

Channel determines which channel is analyzed - left, right or both.

The Refresh slider determines how often Spectrum should perform an analysis. As with the Block parameter, this allows for a tradeoff between accuracy and CPU load. A fast response time is more accurate, but also more CPU intensive.

The Avg slider allows you to specify how many blocks of samples will be averaged for each update of the display. With a setting of one, each block is shown. This results in much more activity in the display, which can be useful for finding the spectrum of short peaks. As you increase the Avg value, the display updates more smoothly, providing an average of the spectrum over time. This is more consistent with the way we actually hear.

The Graph button switches between displaying the spectrum as a single interpolated line and discrete frequency bins.

The Scale X buttons allow you to toggle the scaling of the frequency display between linear, logarithmic, and semitone. Note that logarithmic and semitone are actually the same scaling, but switch the legending at the top of the display between Hertz and note names. Linear scaling is particularly useful for detailed analysis of high frequencies.

As you move your mouse over Spectrum's display, a box appears that shows the amplitude, frequency and note name at the pointer's position. The Range/Auto button at the bottom left of Spectrum's interface toggles between manually and automatically adjusting the display's dynamic range. With Range selected, you can zoom and scroll the amplitude by moving your mouse over the amplitude legending on the display's left side. Drag vertically to scroll and horizontally to zoom. You can also use the Range sliders to set the minimum and maximum amplitude values shown. With Auto selected, the display automatically scales itself based on the incoming audio level. Note that in Auto mode, the Range sliders and zooming are disabled.

To get an even better view, you can toggle the location of the display between the device chain and Live's main window by clicking the  button in Spectrum's title bar.

21.29 Utility



The Utility Effect.

Utility can perform some very useful tasks, especially in combination with other devices.

The Mute button simply silences the incoming signal when enabled. *Note:* The active/mute controls of a track are always placed at the very end of the signal chain. However, since you can place Utility anywhere in a signal chain, you can use its mute function to cut the input of a delay line or reverb without turning off the output of these devices.

The Gain control adjusts the level of the input signal +/- 35 dB.

The Channel Mode chooser allows selective processing of the left and right channels of a sample. If, for example, Left is selected, the right channel is ignored and the left channel appears on both outputs. This is especially useful if you have a stereo file that contains different information on both channels and you want to use only one.

The Panorama chooser pans the signal anywhere in the stereo field.

The Width control acts as a continuous mono to stereo controller when set from 0 to 100 percent. However, beyond 100 percent the output starts to “fold in” on itself. At 200 percent the output contains only the difference between the left and right channels. If either Left or Right have been chosen in the Channel Mode chooser, the Width control has no function and is therefore disabled.

At the bottom of the device you will find two Phase controls, one for each channel. As their names imply, they invert the phase of each channel.

21.30 Vinyl Distortion

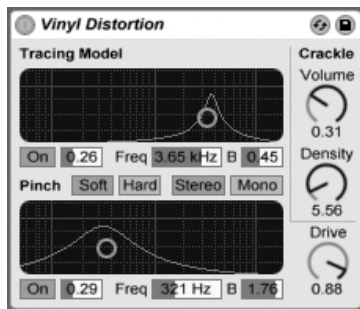

The Vinyl Distortion Effect.

The Vinyl Distortion effect emulates some of the typical distortions that occur on vinyl records during playback. These distortions are caused by the geometric relationships between the needle and the recorded groove. The effect also features a crackle generator for adding noisy artifacts.

The Tracing Model section adds even harmonic distortion to the input signal. Adjust the amount of distortion with the Drive knob, or click and drag vertically in the Tracing Model X-Y display. To adjust the distortion's frequency or "color," drag horizontally in the X-Y display or double-click on the Freq field and type in a value. Holding the **Alt** (PC) / **Alt** (Mac) modifier while dragging vertically in the X-Y display changes the frequency band's Q (bandwidth).

The Pinch Effect section adds odd harmonics to the input signal. These distortions typically occur 180 degrees out of phase, creating a richer stereo image. The Pinch Effect has the same controls as the Tracing Model, but generates a rather different sound.

The Drive control increases or decreases the overall distortion amount created by both the Tracing Model and Pinch.

There are two distortion modes: Soft and Hard. The Soft Mode simulates the sound of a dub plate, while Hard Mode is more like that of a standard vinyl record.

The stereo/mono switch determines whether the Pinch distortion occurs in stereo or mono. Set it to stereo for realistic simulation of vinyl distortions.

The Crackle section adds noise to the signal, with noise density set by the Density control.

The Volume control adjusts the amount of gain applied to the noise.

21.31 Vocoder

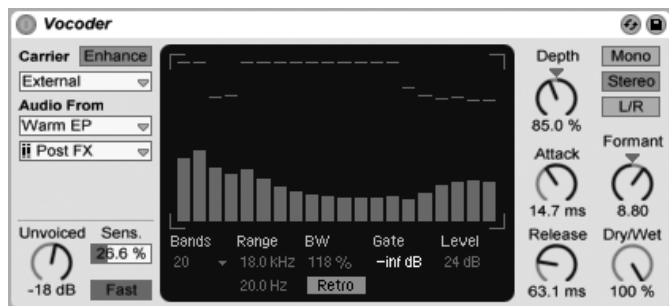

The Vocoder Effect.

A vocoder is an effect that combines the frequency information of one audio signal (called the *carrier*) with the amplitude contour of another audio signal (called the *modulator*). The modulator source is generally something with a clear rhythmic character such as speech or drums, while the carrier is typically a harmonically-rich synthesizer sound such as a string or pad. The most familiar application of a vocoder is to create “talking synthesizer” or robotic voice effects.

Vocoders work by running both the carrier and modulator signals through banks of bandpass filters. The output level of each of the modulator’s filters is then analyzed and used to control the volume of the corresponding filter for the carrier signal.

Live’s Vocoder should be inserted on the track that contains the audio material you plan to use as your modulator. The Carrier chooser then provides a variety of options for the carrier signal:

- Noise uses Vocoder’s internal noise generator as the carrier source. With this selected, an X-Y display is shown which allows you to adjust the character of the noise. The horizontal axis adjusts downsampling. Click and drag to the left to decrease the sample rate of the carrier’s output. The vertical axis adjusts the density of the noise. Click and drag downward to decrease the density.

- *External* allows you to select any available **internal routing points** from the choosers below. This is the option you'll want for classic "robot voice" applications.
- *Modulator* uses the modulator itself as the carrier. This essentially outputs a resynthesized version of the modulator signal, but allows you to use Vocoder's sound-shaping controls to adjust the sound.
- *Pitch Tracking* enables a monophonic oscillator, which tunes itself to the pitch of the modulator. The High and Low sliders allow you to limit the frequency range that the oscillator will attempt to track. Choose from sawtooth or one of three pulse waveforms and adjust the coarse tuning of the oscillator via the Pitch slider. Pitch tracking is particularly effective with monophonic modulator sources such as melodic instruments or voices. Note that the oscillator only updates its frequency when it detects a clear pitch. It then maintains this pitch until it detects a new one. This means that changing the oscillator's parameters or causing it to reset (when **grouping** Vocoder's track, for example) can cause unexpected changes in the sound. With polyphonic material or drums, pitch tracking is generally unpredictable (but can be very interesting.)

Particularly when using external carrier sources, a vocoder's output can sometimes lose a lot of high end. Enabling the Enhance button results in a brighter sound by normalizing the spectrum and dynamics of the carrier.

The Unvoiced knob adjusts the volume of an additional noise generator, which is used to resynthesize portions of the modulator signal that are pitchless, such as "f" and "s" sounds.

Sens. sets the sensitivity of the unvoiced detection algorithm. At 100%, the unvoiced noise generator is always on. At 0%, only the main carrier source is used. The Fast/Slow switch adjusts how quickly Vocoder switches between unvoiced and voiced detection.

Vocoder's large central area shows the levels of the individual bandpass filters. Clicking within this display allows you to attenuate these levels.

The Bands chooser sets the number of filters that will be used. Using more bands results in a more accurate analysis of the modulator's frequency content, but requires more CPU.

The Range sliders adjust the frequency range over which the bandpass filters will operate. For most sources, a fairly large range works well, but you may want to adjust the outer limits if the sound becomes too piercing or bassy. The BW control sets the bandwidth of the filters. At low percentages, each filter approaches a single frequency. As you increase the

bandwidth, you increase the overlap of the filter bands. A bandwidth of 100% is the most accurate, but higher or lower settings can create interesting effects.

The Precise/Retro switch toggles between two types of filter behavior. In Precise mode, all filters have the same gain and bandwidth. In Retro mode, bands become narrower and louder at higher frequencies.

Gate sets a threshold for the filterbank. Any bands whose levels are below the threshold will be silent.

The Level slider boosts or cuts Vocoder's output.

Depth sets how much of the modulator's amplitude envelope is applied to the carrier's signal. At 0%, the modulator's envelope is discarded. At 200%, only high amplitude peaks will be used. 100% results in "classic" vocoding.

The Attack and Release controls set how quickly Vocoder responds to amplitude changes in the modulator signal. Very fast times preserve the transients of the modulator, but can cause distortion artifacts.

The Mono/Stereo switches determine how many channels are used for the carrier and modulator. In Mono mode, both the carrier and modulator are treated as mono sources. Stereo uses a mono modulator but processes the carrier in stereo. L/R processes both the carrier and modulator signals in stereo.

The frequencies of the carrier's filterbank can be shifted up or down via the Formant knob. With voice as the modulator, small Formant changes can alter the apparent gender of the source.

The Dry/Wet control adjusts the balance between the processed and dry signals.

21.31.1 Vocoder Tips

This section explains how to set up the most common Vocoder applications.

Singing Synthesizer

The classic vocoder application is the "singing synthesizer." To set this up in Live:

1. Insert Vocoder in the track that contains your vocal material. You can either use a clip that contains a prerecorded voice clip or, to process a live vocal signal, connect a microphone to a channel on your audio hardware and choose this as the **input source** for the track.
2. Insert a synthesizer such as **Analog** in another track. Again, you can either create a MIDI clip to drive this synthesizer or **play it live**.
3. Set the vocoder's Carrier chooser to External.
4. Select the synthesizer track in the vocoder's Audio From choosers. (For best results, choose Post FX in the bottom chooser.)
5. If you're creating your synthesizer and vocal material in real time, make sure the **Arm** button is enabled on both tracks.
6. Play the synthesizer as you speak into the microphone. You'll hear the rhythm of your speech, but with the timbral character and frequencies of the synthesizer. To hear the vocoded signal alone, solo the voice track so that the "normal" synthesizer track is muted.

Note: you'll generally get the best results if your synthesizer sound is bright and rich in harmonics. Try sawtooth-based patches to improve the intelligibility of the voice. For even more brightness and clarity, try adjusting the Unvoiced control and/or enabling Enhance.

Formant Shifter

If the Vocoder is set to use the modulator as its own carrier, it can be used as a powerful formant shifter. To do this:

1. Set the Carrier chooser to Modulator.
2. Set the Depth to 100%.
3. Enable Enhance.

Now experiment with different settings of the Formant knob to alter the character of the source. For even more sound-sculpting possibilities, try adjusting the various filterbank parameters as well.

Chapter 22

Live MIDI Effect Reference

Live comes with a selection of custom-designed, built-in MIDI effects. The [“Working with Instruments and Effects” chapter](#) explains the basics of using effects in Live.

22.1 Arpeggiator

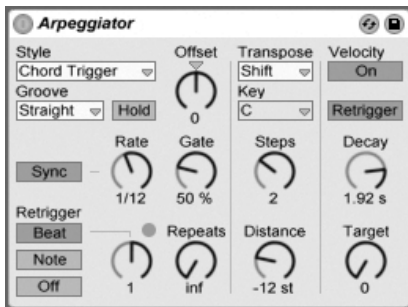

The Arpeggiator Effect.

Live's Arpeggiator effect takes the individual MIDI notes from a held chord (or single note), and plays them as a rhythmic pattern. The sequence and speed of the pattern can be

controlled by the device, which also provides a full complement of both classic and original arpeggiator features.

Arpeggiators are a classic element in Eighties synth music. The name originates with the musical concept of the “arpeggio,” in which the notes comprising a chord are played as a series rather than in unison. “Arpeggio” is derived from the Italian word “arpeggiare,” which refers to playing notes on a harp.

22.1.1 Style and Rate Sections

Arpeggiator’s Style chooser determines the sequence of notes in the rhythmical pattern.



“Up” and “Down”.



*“UpDown” and
“DownUp”.*



*“Down & Up” and “Up
& Down”.*



*“Converge” and
“Diverge”.*



“Con & Diverge”.



"Pinky Up" and "Pinky UpDown".

"Thumb Up" and "Thumb UpDown".

Play Order places notes in the pattern according to the order in which they are played. This is therefore only recognizable when more than one chord or note has been played.

In addition to the Arpeggiator styles above, there are three settings for creating random arpeggios:

- Choosing *Random* will produce a continuously randomized sequence of the incoming MIDI notes.
- *Random Other* creates random patterns from incoming MIDI notes, but will not repeat a given note until all other incoming notes have been used.
- *Random Once* creates one random pattern from incoming MIDI notes and repeats that pattern until the incoming MIDI changes, at which point a new pattern is created.

Arpeggiator will play the pattern of notes at the speed set by the Rate control, which can be calibrated in either milliseconds or beat-time using the neighboring Sync/Free button. With Sync chosen, Arpeggiator will be synced to the song tempo.

A Gate control to the right of Rate determines the length of notes played by Arpeggiator as a percentage of the current Rate setting. Any setting larger than 100% will therefore play notes that overlap (i.e., are legato).

The rhythmic pattern generated by Arpeggiator does not necessarily have to be straight; a selection of groove patterns can be applied with the respective control just beneath the Mode chooser. Grooves in Arpeggiator behave similarly to [grooves in clips](#), and the intensity of the groove is determined by the Amount slider in the [Groove Pool](#).

With the Hold parameter active, Arpeggiator will continue to play the pattern even after the keyboard keys have been released. The pattern will be repeated until any other key is pressed. When Hold is active and any of the original keys also remain physically held, notes

can be added to the pattern simply by playing them. Notes can also be removed from the pattern in this scenario by playing them a second time, allowing the gradual buildup and rearrangement of the pattern over time.

Tip: If you want the pattern to stop playing, momentarily deactivate Hold.

The Offset parameter shifts the sequence of notes in the pattern by the number of places selected with the control. This is best illustrated with an example: A setting of "1" makes the second note in the pattern play first, and the first note last. If you imagine the pattern as a circle of notes that is played in a clockwise direction from a set start point, the Offset parameter effectively rotates this circle counter-clockwise one note at a time, changing where in the pattern play begins.

With the Repeats parameter, the pattern can be set to repeat a specified number of times until it is retriggered. A setting of "inf" will repeat the pattern indefinitely. *Hint:* This feature provides an excellent way of emulating the strum of a guitar or playing a chord as an arpeggio once or twice. Another interesting effect can be achieved by combining this feature with the Retrigger parameter, which we will explain in a moment. This can be used to create rhythmically generated arpeggios separated by pauses.

The Retrigger parameter resets the pattern so that it starts again from the beginning. Retriggering can be deactivated (Off), set to occur when new notes are pressed (Note) or set to occur at a specified song position or beat-time (Beat). Beat retriggering can be specified in terms of notes or bars and is aligned with song position. An LED in the upper right corner of the section indicates when the pattern has been retriggered.

22.1.2 Transposition and Velocity Sections

The pattern generated by Arpeggiator can be transposed; the device's transposition controls allow forcing this transposition into a specific major or minor key or (using the Transpose chooser's Shift option) doing it in semitones. The distance between transposition steps is set in scale intervals (for Major and Minor transposition) or semitones (for Shift transposition) with the Distance control. Using the Steps parameter, you can choose the number of times the sequence is transposed. When Distance is set to a positive value, a setting of 8 Steps will transpose the sequence a total of eight times, playing it in higher notes each time. (When Distance is set to a negative value, the sequence will transpose lower each time.)

The dynamics of Arpeggiator are controlled using the velocity section. With Velocity set to “On” and Target set to 0, for example, the sequence will gradually fade out, eventually reaching 0 velocity. The Decay control sets the amount of time Arpeggiator takes to reach the Target velocity. With Retrigger activated, retriggering of the sequence will also retrigger the velocity slope.

Tip: The velocity section’s Retrigger option can be used in conjunction with Beat retriggering to add rhythm to the dynamic slope.

22.2 Chord

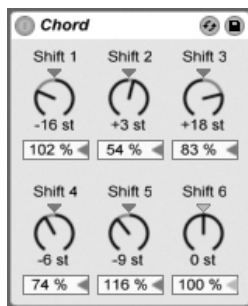

The Chord Effect.

This effect assembles a chord, as the name implies, from each incoming note and up to six others of user-defined pitch. The Shift 1-6 knobs allow selecting the pitch of the notes that contribute to the chord from a range of +/- 36 semitones relative to the original. Setting Shift 1 to +4 semitones and Shift 2 to +7 semitones, for example, yields a major chord in which the incoming note is the root.

The Velocity control beneath each Shift knob makes further harmonic sculpting possible, given that the instrument allows for changes in volume or timbre as function of velocity. It is a relative control, with a range of 1 to 200 percent (100 percent defined as playing at a velocity equal to that of the incoming MIDI note). Use the Velocity controls to do anything from adding slight overtones to washing out most of the other chord elements.

The order in which pitches are added to the chord is inconsequential: The effect of a +12 semitone shift added with the Shift 1 control, for example, is equal in effect to a +12 semitone shift added with the Shift 6 control.

Note that no two notes of the same pitch can contribute to the chord, and that selecting the same shift value twice (e.g., +8 semitones on both Shift 2 and Shift 3) will result in the latter control appearing disabled, indicating that it is a duplicate and therefore not in use. Actually, there is no such thing as two notes with the same pitch playing at the same time within the entire Live universe.

22.3 Note Length

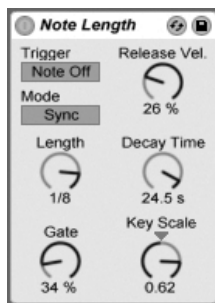

The Note Length Effect.

Note Length alters the length of incoming MIDI notes. It can also be used to trigger notes from MIDI Note Off messages, instead of the usual Note On messages.

When the device is set to trigger from a Note On message, only the timing controls are available. The length of held notes can be adjusted in milliseconds or synced in relation to the song tempo. Gate defines the percentage of the Length value that notes should be held for. At 200 percent, the Gate parameter will double a note's length.

When the device is set to trigger from a Note Off event (the moment at which a played note is released), the timing of an incoming note will be delayed by its length (because it will be *starting* at the point at which it would have been *stopping*). Note Length's other settings will then determine the duration of the newly triggered note.

Three other parameters are available when the device is triggering from Note Off messages:

On/Off Balance – This determines the velocity of the output note. It is a balance between the incoming note's Note On and Note Off velocities. If your MIDI keyboard does not support MIDI Note Off velocity, you can just set this to zero.

Decay Time – This is the time needed for an incoming note’s velocity to decay to zero. The decay begins immediately from the moment the device receives a MIDI Note On message. The value at the time of Note Off will become the velocity of the output MIDI note.

Key Scale – The pitch of incoming notes can be used to alter the length of the output notes. With positive values, notes below C3 will be made progressively longer, and notes above C3 will be made shorter. Negative values will invert this relationship.

22.4 Pitch



The Pitch Effect.

Pitch is a transposition tool that changes incoming note pitch by +/- 128 semitones.

The Range and Lowest controls act together to define a pitch range through which notes are allowed to pass. Notes outside of the defined pitch range will be blocked, and the effect’s LED light will flash when this happens.

Notes outside of the pitch range are limited based on their untransposed pitch, prior to the transposition stage of the effect.

22.5 Random

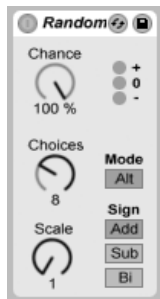

The Random Effect.

Random adds an element of the unknown to the otherwise commonplace pitch parameter. The Chance control defines the likelihood that an incoming note's pitch will be changed by a random value. You can think of it as being something like a dry/wet control for randomness.

The random value that determines the pitch change is created by two variables: The Choices control defines the number of different random notes possible, from a range of 1 to 24; the Scale control value is multiplied by the Choices control value, and the result dictates the pitches that random notes are allowed to have relative to that of the incoming note.

For example, if you play the note C3 with Chance set to 50 percent, Choices set to 1 and Scale set to 12, half of the resulting notes will play at C3 and half will play at C4. But with Chance set to 50 percent, Choices set to 12 and Scale set to 1, half of the resulting notes will play at C3 and half will play at one of any semitone that is between C#3 and C4.

These examples assume that the Sign buttons are set to "Add" and the Mode button is set to "Rnd." The Sign controls decide whether the random alteration adds to the original note's pitch, subtracts from it, or does a little of both. The LEDs below the Sign controls give you a visual idea of how output pitch compares with that of the original.

The Mode button determines whether the alteration will be random or, when set to "Alt," will cycle between the allowed output notes in a fixed order (sometimes known as "cycle round-robin"). The Chance control behaves a bit differently in Alt mode - at 100 percent, the next output note will always be the next note in the series. At 0 percent, the next output note will always be the incoming note.

For example, with Chance set to 100 percent, Choices set to 12 and Scale set to 1, playing

C3 once will trigger C3, and each successive C3 will trigger the next semitone higher until the device reaches C4, at which point it will start over at C3. But with Chance set to 100 percent, Choices set to 2 and Scale set to 2, incoming C3s will alternate between C3 and D3. This setting is perfect for simulating upbow and downbow alternation with stringed instruments, or alternating right- and left-hand drum samples.

Hint: Try using the *Scale* effect after *Random* to constrain the output values to a specific harmonic range. Using *Random*'s Alt mode with the *Scale* device allows you to create a simple step-sequencer.

22.6 Scale

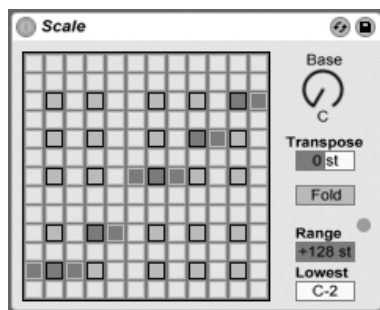

The Scale Effect.

Scale alters incoming note pitch based on a scale mapping. Each incoming note is given an outgoing equivalent on the X-Y scale map of the effect: All incoming Cs, for example, might be converted to outgoing Ds.

The X-Y scale map is 12 squares in length and width, corresponding to the 12 notes in a full octave. Darker squares represent the black keys on a keyboard. The base of the diagonal scale (the lower left square) shown on the map can be changed using the Base control. The X-axis of the map shows incoming note values, and the Y-axis their outgoing equivalents. Use mouse-clicks to move or delete the yellow squares, which define where an incoming note will be sent on the scale. (Deleting a note on the scale map means that it will no longer play.)

The Range and Lowest controls work together to define the note range within which scale

mapping will take effect. Outside of the range defined by these controls, the Scale effect will be inapplicable, and the LED light will flash to indicate that some notes are not being processed by the effect, but are playing at their unaltered pitch.

22.7 Velocity

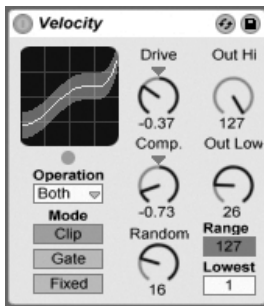

The Velocity Effect.

Velocity re-maps the 127 MIDI note velocity values. It can function on MIDI Note On or Note Off messages, or both, depending on the setting of the Operation chooser.

The Out Low and Out Hi knobs control the outgoing velocity (from 1 to 127), which is represented by the Y-axis of the X-Y display. Incoming velocities that are shown in the display are within the range chosen by the Range and Lowest controls, and are represented on the X-axis. The resulting curve shows how velocity is being altered by the effect.

If *Lowest* and *Out Low* are both set to zero, and *Range* and *Out Hi* are set to 127, the display will show a straight diagonal line that indicates the equivalent of an effect bypass: Softly played notes are being output quietly, and vice versa. If instead, *Out Hi* is set to zero and *Out Low* to 127, the slope of the line will be reversed, and softly played notes will actually produce the loudest output.

What happens to incoming notes that are outside of the range set with the Range and Lowest controls? This depends on which Mode is selected.

- Clip Mode does just what it says: It clips incoming note velocities so that they stay within the range.

- Gate Mode removes incoming notes altogether if their velocities are outside of the range. You will see the little LED below the X-Y display flash when a note is blocked by gating.
- In Fixed Mode, the Out Hi velocity defines all outgoing note velocities, regardless of incoming note velocity.

The Random function adds or subtracts a random value to the all velocities, and is represented by a gray area on the display curve.

The Drive and Comband controls can be combined to create more complex curves. Comband is a simultaneous expanding and compressing tool. When set to values greater than zero, it forces incoming notes to the outer boundaries of the curve, making them play either loudly or softly. Comband values of less than zero, on the other hand, force outgoing velocity toward the mid-range. Drive pushes all values in the curve to the outer extremes. Use these two controls together to sculpt or even redefine the dynamic structure of a piece.

Chapter 23

Live Instrument Reference

Live comes with a selection of custom-designed, built-in instruments. The [“Working with Instruments and Effects” chapter](#) explains the basics of using instruments in Live.

The boxed version of Live 8 ships with the *Essential Instrument Collection*, a multi-gigabyte library of meticulously sampled and selected instruments ready for use in either Simplifier or Sampler. Learn how to access the EIC sounds at the [end of this chapter](#).

23.1 Analog

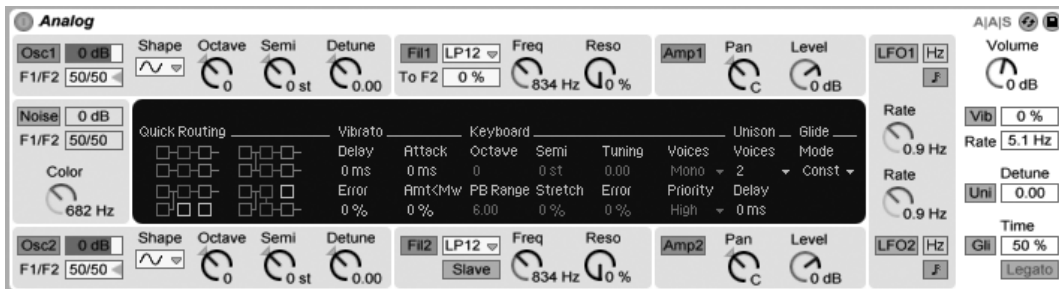

Analog is a virtual analog synthesizer, created in collaboration with Applied Acoustics Systems. With this instrument, we have not attempted to emulate a specific vintage analog synthesizer but rather to combine different features of legendary vintage synthesizers into a modern instrument. Analog generates sound by simulating the different components of the synthesizer through physical modeling. This technology uses the laws of physics to reproduce how an object or system produces sound. In the case of Analog, mathematical equations describing how analog circuits function are solved in real time. Analog uses no sampling or wavetables; the sound is simply calculated in real time by the CPU according to the values of each parameter. This sound synthesis method ensures unmatched sound quality, realism, warmth and playing dynamics.

The full version of Analog is not included with the standard version of Live, but is a special feature available for purchase separately.

23.1.1 Architecture and Interface

Analog's signal flow is shown in the figure below:

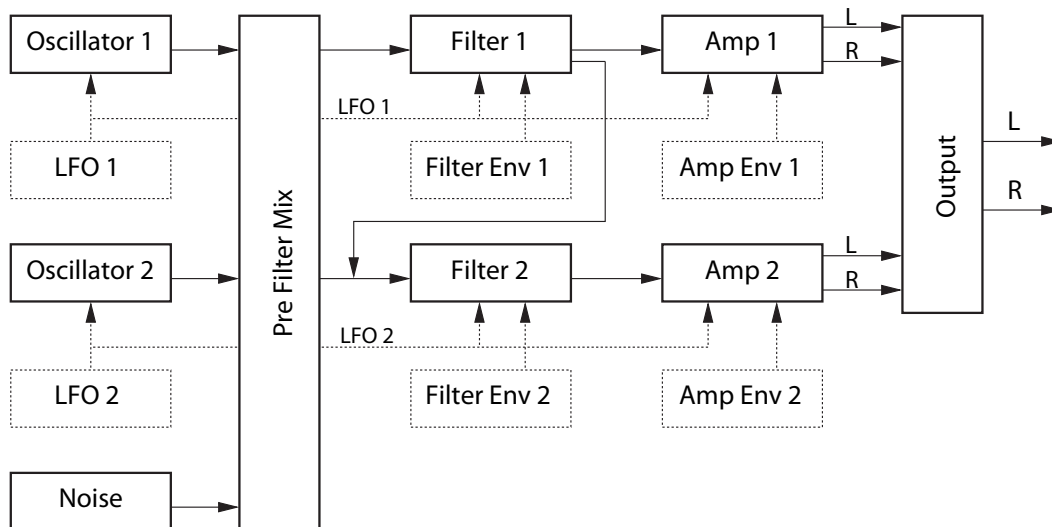

Diagram of Analog's Signal Flow.

The primary sound sources of the synthesizer are two oscillators and a noise generator.

These sources can be independently routed to two different multi-mode filters, which are each connected to an amplifier. Furthermore, the signal flow can be run through the filters in series or in parallel.

Analog also features two low-frequency oscillators (LFOs) which can modulate the oscillators, filters and amplifiers. Additionally, each filter and amplifier has its own envelope generator.

The Analog interface consists of two parts: the *display* surrounded on all sides by the *shell*. The shell contains the most important controls for a given section while the display updates to show parameter visualizations and additional controls for the selected section. In addition to the synthesis modules, there is a Global section that contains general performance parameters such as instrument volume, vibrato and polyphony.

23.1.2 Oscillators

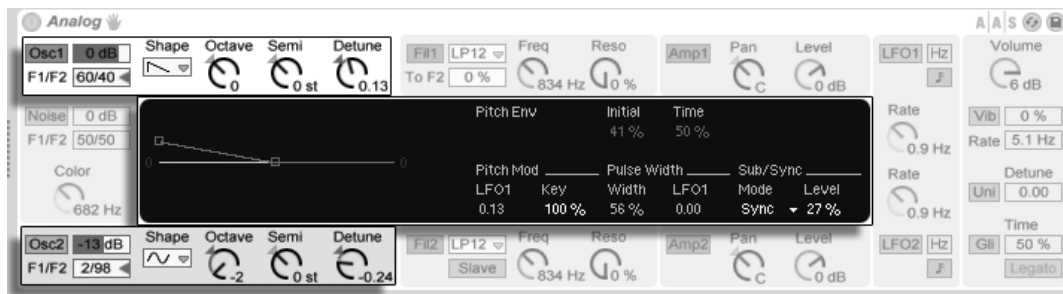

Display and Shell Parameters for the two Oscillators.

Analog's two oscillators use physical modelling to capture the character of vintage hardware oscillators. Because they use modelling instead of wavetables, they avoid aliasing.

Each oscillator can be turned on or off independently via the switch labelled Osc 1 or Osc 2 in the shell, and the oscillator's output level is adjusted by the slider to the right of this activator.

The F1/F2 slider controls the balance of the oscillator's output to each of the two filters. When the slider is at the center position, equal amounts of signal will be sent to both filters. When set all the way to the top or bottom, signal will only be sent to Filter 1 or Filter 2 respectively.

The Shape chooser selects the oscillator's waveform. The choices are sine, sawtooth, rectangular and white noise. When rectangular is selected, the Pulse Width parameter is enabled in the display, which allows you to change the pulse width of the waveform. Low Width values result in a very narrow waveform, which tends to sound tinny or "pinched." At 100%, the waveform is a perfect square, resulting in only odd harmonics. The pulse width can also be modulated by an LFO, via the slider next to Width. Note that this parameter is only enabled when the corresponding LFO is enabled.

The Octave, Semi and Detune knobs in the shell function as coarse and fine tuners. Octave transposes the oscillator by octaves, while Semi transposes up or down in semitone increments. The Detune knob adjusts in increments of one cent (up to a maximum of three semitones (300 cents) up or down).

Oscillator pitch can be modulated according to the settings of the Pitch Mod and Pitch Env parameters in the display. The LFO slider sets the amount that the LFO modulates pitch. Again, this parameter is only enabled if the LFO is on. The Key slider controls how much the oscillator tuning is adjusted by changes in MIDI note pitch. The default value of 100% means that the oscillator will conform to a conventional equal tempered scale. Higher or lower values change the amount of space between the notes on the keyboard. At 0%, the oscillator is not modulated by note pitch at all. To get a sense of how this works, try leaving one of the oscillators at 100% and setting the other's Key scaling to something just slightly different. Then play scales near middle C. Since C3 will always trigger the same frequency regardless of the Key value, the oscillators will get farther out of tune with each other the farther away from C3 you play.

The Pitch Env settings apply a ramp that modulates the oscillator's pitch over time. Initial sets the starting pitch of the oscillator while Time adjusts how long it will take for the pitch to glide to its final value. You can adjust both parameters via the sliders or by adjusting the breakpoints in the envelope display.

The Sub/Sync parameters in the display allow you to apply either a sub-oscillator or a hard synchronization mode. When the Mode chooser is set to Sub, the Level slider sets the output level of an additional oscillator, tuned an octave below the main oscillator. The sub-oscillator produces a square wave when the main oscillator's Shape control is set to rectangle or sawtooth and a sine wave when the main oscillator is set to sine. Note that the sub-oscillator is disabled when the main oscillator's Shape is set to white noise.

When the Mode chooser is set to Sync, the oscillator's waveform is restarted by an internal

oscillator whose frequency is set by the Ratio slider. At 0%, the frequency of the internal oscillator and the audible oscillator match, so sync has no effect. As you increase the Ratio, the internal oscillator's rate increases, which changes the harmonic content of the audible oscillator. For maximum analog nastiness, try mapping a modulation wheel or other MIDI controller to the Sync ratio.

23.1.3 Noise Generator

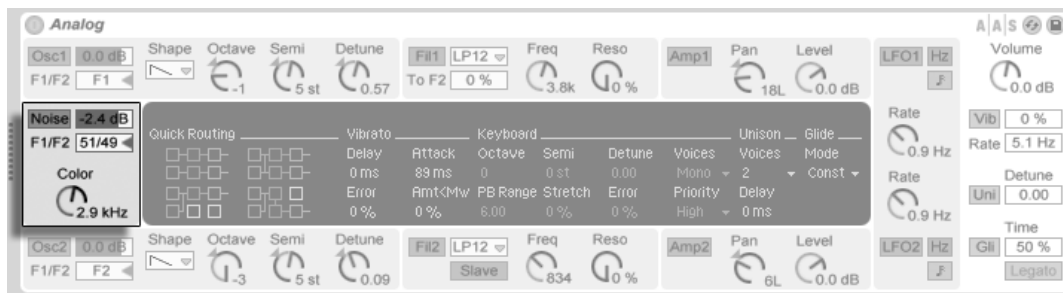

Analog's Noise Generator.

The Noise generator produces white noise and includes its own -6dB/octave low-pass filter. The generator can be turned on or off via the Noise switch in the shell. Its output level is adjusted by the slider to the right of this activator.

The F1/F2 slider controls the balance of the noise generator's output to each of the two filters. When the slider is at the center position, equal amounts of signal will be sent to both filters. When set all the way to the top or bottom, signal will only be sent to Filter 1 or Filter 2 respectively.

The Color knob sets the frequency of the internal low-pass filter. Higher values result in more high-frequency content.

Note that Noise has only shell parameters, so adjusting them does not change what is shown in the display.

23.1.4 Filters



Display and Shell Parameters for the two Filters.

Analog's two multi-mode filters come equipped with a flexible routing architecture, multiple saturation options and a variety of modulation possibilities. As with the oscillators, all parameters can be set independently for each filter.

The Fil 1 and Fil 2 switches in the shell toggle the respective filter on and off. The chooser next to the filter activator selects the filter type from a selection of 2nd and 4th order low-pass, band-pass, notch, high-pass and formant filters.

The resonance frequency of the filter is adjusted with the Freq knob in the shell, while the amount of resonance is adjusted with the Reso control. When a formant filter is chosen in the chooser, the Reso control cycles between vowel sounds.

Below each mode chooser is an additional control which differs between the two filters. In Filter 1, the To F2 slider allows you to adjust the amount of Filter 1's output that will be sent to Filter 2. The Slave switch below Filter 2's mode chooser causes this filter's cutoff frequency to follow the cutoff of Filter 1. If this is enabled, Filter 2's cutoff knob controls the amount of offset between the two cutoff amounts. If any of Analog's modulation sources are controlling Filter 1's cutoff, Filter 2 will also be affected by them when Slave is enabled.

In addition to the **envelope** controls, the displays for the filters contain various modulation parameters and the Drive chooser. Cutoff frequency and resonance can be independently modulated by LFO, note pitch and filter envelope via the sliders in the Freq Mod and Res Mod sections respectively. Positive modulation values will increase the cutoff or resonance amounts, while negative values will lower them.

The Drive chooser in the display selects the type of saturation applied to the filter output.

The three Sym options apply symmetrical distortion, which means that the saturation behavior is the same for positive and negative values. The Asym modes result in asymmetrical saturation. For both mode types, higher numbers result in more distortion. Drive can be switched off entirely by selecting Off in the chooser. Experiment with the various options to get a sense of how they affect incoming signals.

23.1.5 Amplifiers

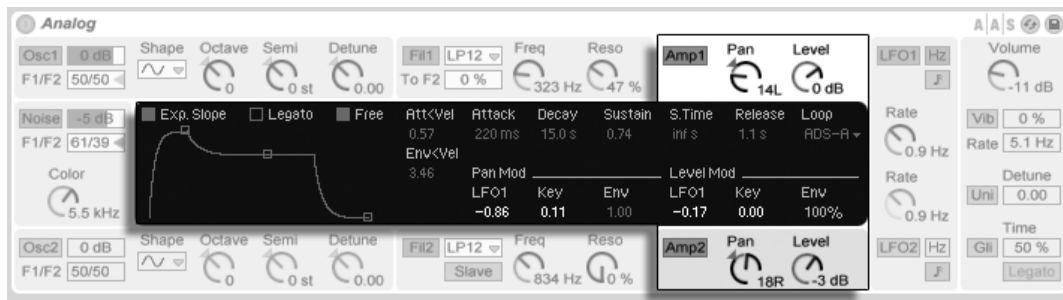

Display and Shell Parameters for the two Amplifiers.

After the filters, the signal is routed to an amplifier which further shapes the sound with an amplitude envelope and panning. All parameters can be set independently for each amplifier.

The Amp 1 and Amp 2 switches in the shell toggle the respective amplifier on and off, while the output level is controlled by the Level knob. The Pan knob sets the position of the amplifier's output in the stereo field.

In addition to the **envelope** controls, the displays for the amplifiers contain various modulation parameters. The Pan and Level amounts can be independently modulated by LFO, note pitch and amp envelope via the sliders in the Pan Mod and Level Mod sections respectively. Note that, when using note pitch as the modulation source for Level, middle C will always sound the same regardless of the modulation amount. Positive values will cause the level to increase for higher notes.

23.1.6 Envelopes



Analog's Envelope Parameters.

In addition to the pitch envelopes in the oscillator sections, Analog is equipped with independent envelopes for each filter and amplifier. All four of these envelopes have identical controls, which are housed entirely within the display. Each envelope is a standard ADSR (attack, decay, sustain, release) design and features velocity modulation and looping capabilities.

The attack time is set with the Attack slider. This time can also be modulated by velocity via the Att<Vel slider. As you increase the Att<Vel value, the attack time will become increasingly shorter at higher velocities.

The time it takes for the envelope to reach the sustain level after the attack phase is set by the Decay slider.

The Sustain slider sets the level at which the envelope will remain from the end of the decay phase to the release of the key. When this knob is turned all the way to the left, there is no sustain phase. With it turned all the way to the right, there is no decay phase.

The overall envelope level can be additionally modulated by velocity via the Env<Vel slider.

The S.Time slider can cause the Sustain level to decrease even if a key remains depressed. Lower values cause the Sustain level to decrease more quickly.

Finally, the release time is set with the Release knob. This is the time it takes for the envelope to reach zero after the key is released.

The Slope switches toggle the shape of the envelope segments between linear and exponential. This change is also represented in the envelope visualization.

Normally, each new note triggers its own envelope from the beginning of the attack phase. With Legato enabled, a new note that is played while another note is already depressed will use the first note's envelope, at its current position.

Enabling the Free switch causes the envelope to bypass its sustain phase and move directly from the decay phase to the release phase. This behavior is sometimes called "trigger" mode because it produces notes of equal duration, regardless of how long the key is depressed. Free mode is ideal for percussive sounds.

The Loop chooser offers several options for repeating certain segments of the envelope while a key is depressed. When Off is selected, the envelope plays once through all of its segments without looping.

With AD-R selected, the envelope begins with the attack and decay phases as usual, but rather than maintaining the sustain level, the attack and decay phases will repeat until the note is released, at which point the release phase occurs. ADR-R mode is similar, but also includes the release phase in the loop for as long as the key is held.

Note that in both AD-R and ADR-R modes, enabling Free will cause notes to behave as if they're permanently depressed.

ADS-R mode plays the envelope without looping, but plays the attack and release phases once more when the key is released. With short attack and release times, this mode can simulate instruments with audible dampers.

23.1.7 LFOs

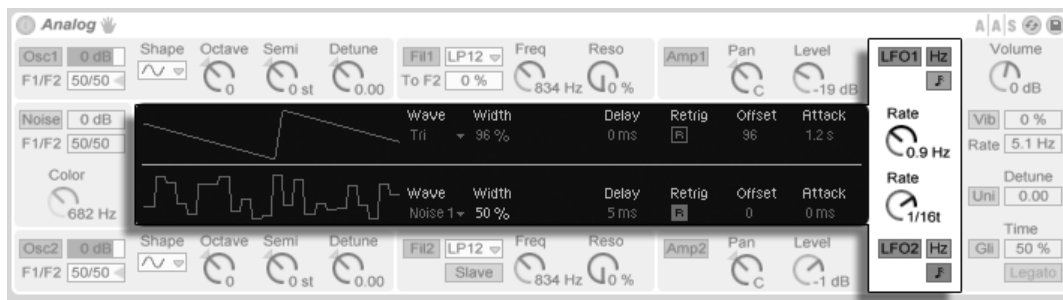

Display and Shell Parameters for the two LFOs.

Analog's two LFOs can be used as modulation sources for the oscillators, filters and amplifiers. As with the other sections, each LFO has independent parameters.

The LFO 1 and LFO 2 switches in the shell toggle the respective LFO on and off, while the Rate knob sets the LFO's speed. The switch next to this knob toggles the Rate between frequency in Hertz and tempo-synced beat divisions.

The Wave chooser in the display selects the waveform for the LFO. The choices are sine, triangle, rectangle and two types of noise. The first noise type steps between random values while the second uses smooth ramps. With Tri or Rect selected, the Width slider allows you to adjust the pulse width of the waveform. With Tri selected, low Width values shift the waveform towards an upwards sawtooth, while higher values result in a downward saw. At 50%, the waveform is a perfect triangle. The behavior is similar with the Rect setting. At 50%, the waveform is a perfect square wave, while lower and higher values result in negative or positive pulses, respectively. Note that Width is disabled when the LFO's waveform is set to sine or the noise modes.

The Delay slider sets how long it will take for the LFO to start after the note begins, while Rate sets how long it takes the LFO to reach its full amplitude.

With Retrigger enabled, the LFO restarts at the same position in its phase each time a note is triggered. The Offset slider adjusts the phase of the LFO's waveform.

23.1.8 Global Parameters

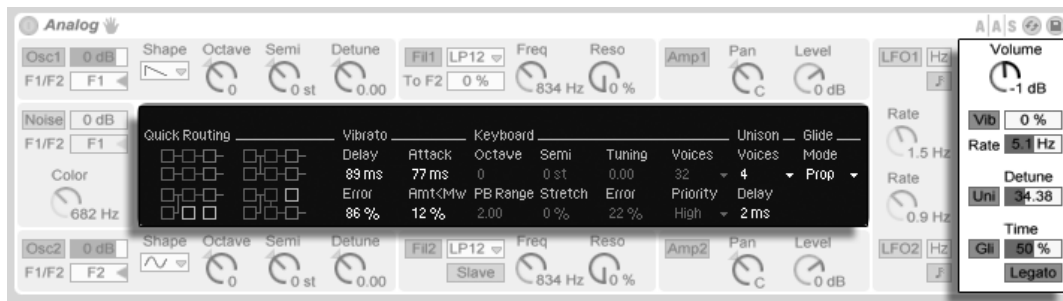

Display and Shell Parameters for the Global Options.

The Global shell and display parameters adjust how Analog responds to MIDI data, as well as controls for performance parameters such as vibrato and glide.

The Volume control in the shell adjusts the overall output of the instrument. This is the instrument's master level, and can boost or attenuate the output of the amplifier sections.

The Vib switch turns the vibrato effect on or off, while the percentage slider next to it adjusts the amplitude of the vibrato. Analog's vibrato effect is essentially an additional LFO, but is hardwired to the pitch of both oscillators. The Rate slider sets the speed of the vibrato.

Turning on the vibrato effect enables the four additional Vibrato parameters in the display. The Delay slider sets how long it will take for the vibrato to start after the note begins, while Attack sets how long it takes for the vibrato to reach full intensity.

The Error slider adds a certain amount of random deviation to the Rate, Amount, Delay and Attack parameters for the vibrato applied to each polyphonic voice.

The Amt<MW slider adjusts how much the modulation wheel will affect the vibrato intensity. This control is relative to the value set by the Amount percentage slider in the shell.

The Uni switch in the shell turns on the unison effect, which stacks multiple voices for each note played. The Detune slider next to this switch adjusts the amount of tuning variation applied to each stacked voice.

Turning on the unison effect enables the two additional Unison parameters in the display. The Voices chooser selects between two or four stacked voices, while the Delay slider increases the lag time before each stacked voice is activated.

The Gli switch turns the glide effect on or off. This is used to make the pitch slide between notes rather than changing immediately. With Legato enabled, the sliding will only occur if the second note is played before the first note is released. The Time slider sets the overall speed of the slide.

Turning on the glide effect enables an additional Glide Mode chooser in the display. Selecting Const causes the glide time to be constant regardless of interval. Choosing Prop (proportional) causes the glide time to be proportional to the interval between the notes. Large intervals will glide slower than small intervals.

The Keyboard section in the display contains all of Analog's polyphony and tuning parameters. The Voices chooser sets the available polyphony, while Priority determines which notes will be cut off when the maximum polyphony is exceeded. When Priority is set to High, new notes that are higher than currently sustained notes will have priority, and notes will be cut off starting from the lowest pitch. Low is the opposite. A Priority setting of Last gives

priority to the most recently played notes, cutting off the oldest notes as necessary.

The Octave, Semi and Tuning controls function as coarse and fine tuners. Octave transposes the entire instrument by octaves, while Semi transposes up or down in semitone increments. The Tuning slider adjusts in increments of one cent (up to a maximum of 50 cents up or down).

PB Range sets the range in semitones of pitch bend modulation.

Stretch simulates a technique known as stretch tuning, which is a common tuning modification made to electric and acoustic pianos. At 0%, Analog will play in equal temperament, which means that two notes are an octave apart when the upper note's fundamental pitch is exactly twice the lower note's. Increasing the Stretch amount raises the pitch of upper notes while lowering the pitch of lower ones. The result is a more brilliant sound. Negative values simulate "negative" stretch tuning; upper notes become flatter while lower notes become sharper.

The Error slider increases the amount of random tuning error applied to each note.

The four Quick Routing buttons in the left side of the display provide an easy way to quickly set up common parameter routings. The upper left option configures a parallel routing structure, with each oscillator feeding its own filter and amplifier exclusively. The upper right button is similar, but the oscillators each split their output evenly between the two filters. The bottom left option feeds both oscillators into Filter 1 and Amp 1, disabling Filter 2 and Amp 2 entirely. Finally, the bottom right option configures a serial routing structure, with both oscillators feeding Filter 1, which is then fed exclusively to Filter 2 and Amp 2.

Note that the Quick Routing options do not affect any changes you may have made to the oscillator level, tuning or waveform parameters – they only adjust the routing of the oscillators to the filters and subsequent amplifiers.

23.2 Collision

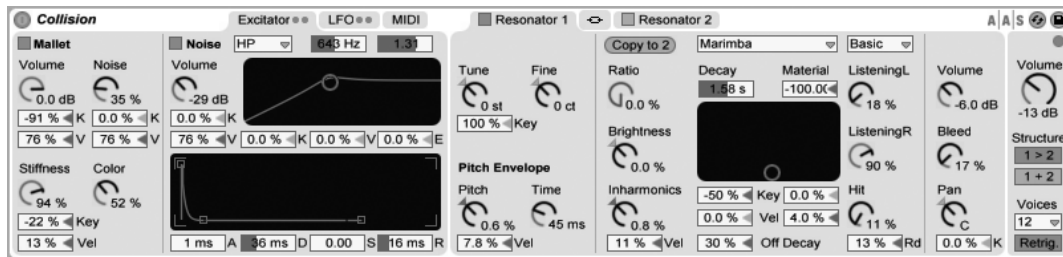

The Collision Instrument.

Collision is a synthesizer that simulates the characteristics of mallet percussion instruments. Created in collaboration with Applied Acoustics Systems, Collision uses physical modeling technology to model the various sound generating and resonant components of real (or imagined) objects.

The full version of Collision is not included with the standard version of Live, but is bundled with the **Corpus** effect as a special feature available for purchase separately.

23.2.1 Architecture and Interface

Collision's sound is produced by a pair of oscillators called *Mallet* and *Noise*, which feed a pair of independent (or linked) stereo *resonators*. While the oscillators produce the initial component of the sound, it is the resonator parameters that have the greatest impact on the sound's character.

Collision's interface is divided into tabs, which are further divided into sections. The *Excitator* tab contains the controls for the Mallet and Noise oscillators. The *Resonator* tabs contain the parameters for the independent resonator sections, while the *Link* tab allows you to adjust both resonators simultaneously.

The *LFO* tab contains two independent low-frequency oscillators (LFOs), which can each modulate multiple parameters. Similarly, the *MIDI* tab allows for MIDI pitch bend, modulation wheel and aftertouch messages to be routed to multiple destinations.

To the right of the resonators is a section of *global* parameters, including overall output volume, polyphony and resonator routing options.

In addition to serving as organizational aids, Collision's tabs contain LEDs that light up to indicate that their contained sections are active. Disabling unused sections can save CPU.

23.2.2 Excitator Tab

The Excitator tab contains parameters for the Mallet and Noise sections. These model the behavior of a mallet striking a surface, and provide Collision's fundamental sound. These section's parameters only control the initial impulse, which is a much smaller component of Collision's overall sound than the resonators.

Note that if both the Mallet and Noise sections are turned off, Collision will not make sound.

The Mallet Section

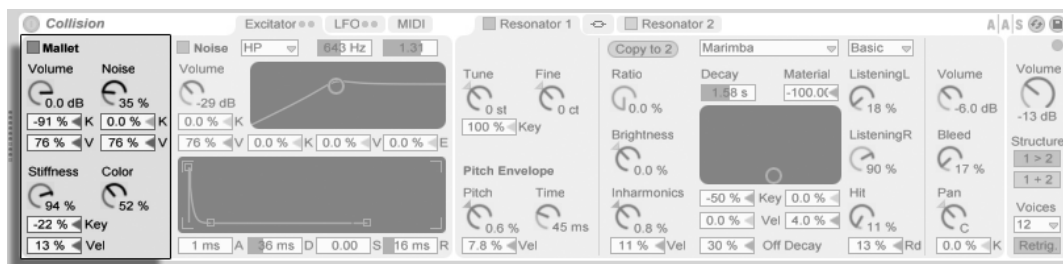

Collision's Mallet Section.

The Mallet section simulates the impact of a mallet against a surface. The parameters adjust the physical properties of the mallet itself.

Volume controls the overall output level of the mallet section, while the Noise knob sets the amount of impact noise that is included in each mallet strike. This is useful for simulating the "chiff" sound of a felt-wrapped mallet head. The Volume and Noise parameters can be modulated by pitch and velocity by adjusting the K (Key) and V (Velocity) sliders, respectively.

The Stiffness knob adjusts the hardness of the mallet. At low levels, the mallet is soft, which results in fewer high frequencies and a longer, less distinct impact. As you increase the stiffness, the impact time decreases and high frequencies increase. This parameter can also be modulated by pitch and velocity via the Key and Vel sliders.

The Color knob sets the frequency of the noise component. At higher values, there are less low frequencies in the noise. This parameter has no effect if Noise is set to 0.

The Mallet section can be toggled on or off via the switch next to its name.

The Noise Section

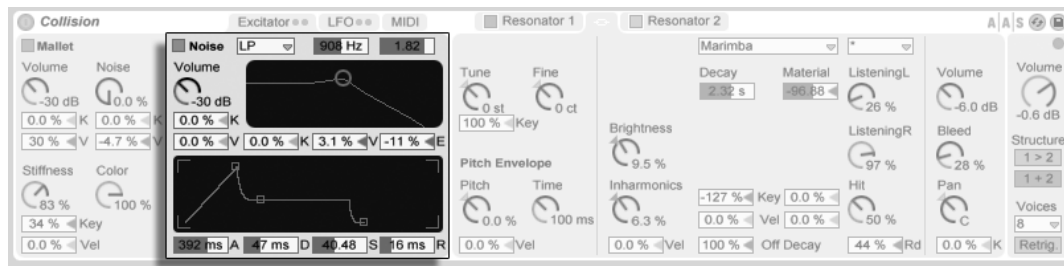

Collision's Noise Section.

The Noise section can be used instead of, or in addition to, the Mallet section. Like the Mallet, the Noise section produces Collision's initial impulse sound. But Noise also produces a white noise component, which is then fed into a multimode filter and a dedicated envelope generator.

Volume controls the overall output level of the Noise section, and can be modulated by pitch and velocity by adjusting the K (Key) and V (Velocity) sliders below the knob, respectively.

To the right are the filter controls. The type chooser allows you to choose between low-pass, high-pass, and two types of band-pass filters. Filter cutoff and resonance can be adjusted by the sliders above the filter display, or by dragging within the display itself. In BP mode, the second slider adjusts resonance, while in LP+HP mode, it adjusts bandwidth. The filter frequency can also be modulated by note pitch, velocity or the envelope generator, via the K, V and E sliders below the display.

The envelope generator is a standard ADSR (attack, decay, sustain, release).

The attack time – how quickly Noise reaches full volume – is set with the A (Attack) slider, while the time it takes for the envelope to reach the sustain level after the attack phase is set by the D (Decay) slider.

The S (Sustain) slider sets the level at which the envelope will remain from the end of the

decay phase to the release of the key. When this slider is set to 0, there is no sustain phase. With it set to 100, there is no decay phase.

Finally, the release time is set with the R (Release) slider. This is the time it takes for the envelope to reach zero after the key is released.

The Noise section can be toggled on or off via the switch next to its name.

23.2.3 Resonator Tabs

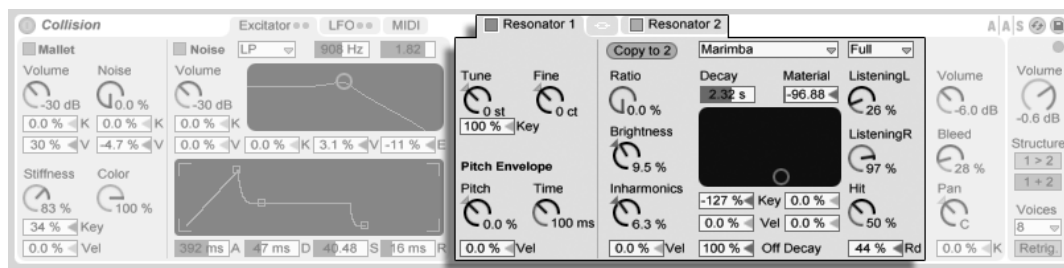

Collision's Resonators.

The majority of Collision's character is determined by the parameters in the two Resonator tabs. Each stereo resonator can be toggled on or off via the switch in its tab. Keep in mind that if both resonators are turned off, no sound will be produced.

Each resonator section is further divided into three subsections. On the left are controls related to tuning. In the center are the controls that determine the physical properties of the resonant object. To the right are mixer controls. Each resonator's center subsection contains a "Copy to" button. Pressing this button copies this subsection's parameter settings from the currently selected resonator to the other resonator.

The "link" tab between the Resonator tabs allows you to adjust parameters for both resonators simultaneously. The behavior here is similar to what happens when you [edit the properties for a multi-selection of clips](#): parameters that have differing values will display the value range (either on the control for knobs or in the status bar for sliders and choosers) and can be adjusted with the linked control. Dragging the parameter to its absolute maximum or minimum value will make the settings thereafter identical, adjustable as a single value.

Tuning Section

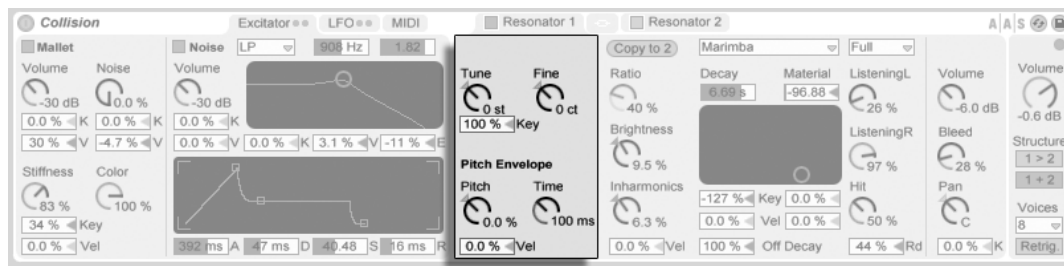

Resonator Tuning Parameters.

The Tune and Fine knobs function as coarse and fine tuning controls. Tune moves up or down in semitone increments, while Fine adjusts in increments of one cent (up to a maximum of one quarter tone (50 cents) up or down).

The Key slider below the Tune knob controls how much the resonator's tuning is adjusted by changes in MIDI note pitch. The default value of 100% means that the resonator will conform to a conventional equal tempered scale. At 200%, each half step on the keyboard will result in a whole step change in tuning. At negative values, the resonator will drop in pitch as you play higher on the keyboard.

The Pitch Envelope parameters apply a ramp that modulates the resonator's pitch over time. Pitch sets the starting pitch while Time adjusts how long it will take the pitch to glide to its final value. The starting pitch can be modulated by velocity via the Vel slider.

Physical Properties Section

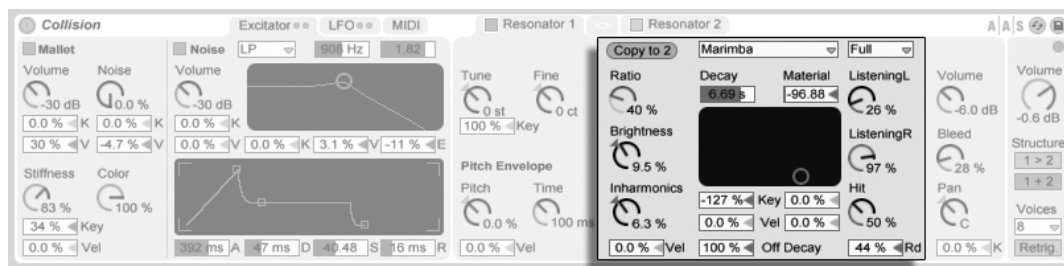

Physical Properties of the Resonator.

The type chooser allows you to select from seven types of physically modeled resonant objects:

- *Beam* simulates the resonance properties of beams of different materials and sizes.
- *Marimba*, a specialized variant of the Beam model, reproduces the characteristic tuning of marimba bar overtones which are produced as a result of the deep arch-cut of the bars.
- *String* simulates the sound produced by strings of different materials and sizes.
- *Membrane* is a model of a rectangular membrane (such as a drum head) with a variable size and construction.
- *Plate* simulates sound production by a rectangular plate (a flat surface) of different materials and sizes.
- *Pipe* simulates a cylindrical tube that is fully open at one end and has a variable opening at the other (adjusted with the Opening parameter.)
- *Tube* simulates a cylindrical tube that is closed at both ends.

The quality chooser controls the tradeoff between the sound quality of the resonators and performance by reducing the number of overtones that are calculated. “Basic” uses minimal CPU resources, while “Full” creates more sophisticated resonances. This parameter is not used with the Pipe or Tube resonators.

The Decay slider adjusts the internal damping of the resonator, which determines its decay time. Off Decay determines the extent to which MIDI note off messages mute the resonance. At 0%, note offs are ignored, and the decay time is based only on the value of the Decay parameter. This is similar to how real-world mallet instruments such as a marimbas and glockenspiels behave. At 100%, the resonance is muted immediately at note off, regardless of the Decay time.

The Material slider adjusts the variation of the damping at different frequencies. At lower values, low frequency components decay slower than high frequency components (which simulates objects made of wood, nylon or rubber). At higher values, high frequency components decay slower (which simulates objects made of glass or metal). This parameter is not used with the Pipe or Tube resonators.

The Radius parameter is only available for the Pipe and Tube resonators. This slider adjusts

the radius of the pipe or tube. As the radius increases, the decay time and high frequency sustain both increase. At very large sizes, the fundamental pitch of the resonator also changes.

The Decay and Material/Radius parameters can also be controlled with the X-Y controller, and modulated by note pitch and velocity via the sliders below the X-Y panel.

Ratio is only available for the Membrane and Plate resonators, and adjusts the ratio of the object's size along its x and y axes.

The Brightness control adjusts the amplitude of various frequency components. At higher values, higher frequencies are louder. This parameter is not used with the Pipe or Tube resonators.

The Inharmonics knob adjusts the pitch of the resonator's harmonics. At negative values, frequencies are compressed, increasing the amount of lower partials. At positive values, frequencies are stretched, increasing the amount of upper partials. This parameter is not used with the Pipe or Tube resonators. Inharmonics can also be modulated by velocity via the slider below the knob.

Opening, which is only available for the Pipe resonator, scales between an open and closed pipe. At 0%, the pipe is fully closed on one side, while at 100% the pipe is open at both ends. This parameter can also be modulated by velocity via the slider below the knob.

The Listening L and R controls adjust the location on the left and right resonator where the vibrations are measured. At 0%, the resonance is monitored at the object's center. Higher values move the listening point closer to the edge. These parameters are not used with the Pipe or Tube resonators, which are always measured in the middle of their permanently open end.

The Hit knob adjusts the location on the resonator at which the object is struck or otherwise activated. At 0%, the object is hit at its center. Higher values move the activation point closer to the edge. This parameter is not used with the Pipe or Tube resonators. The Hit position can also be randomized by increasing the value of the Rd. (Random) slider below the knob.

Mixer Section

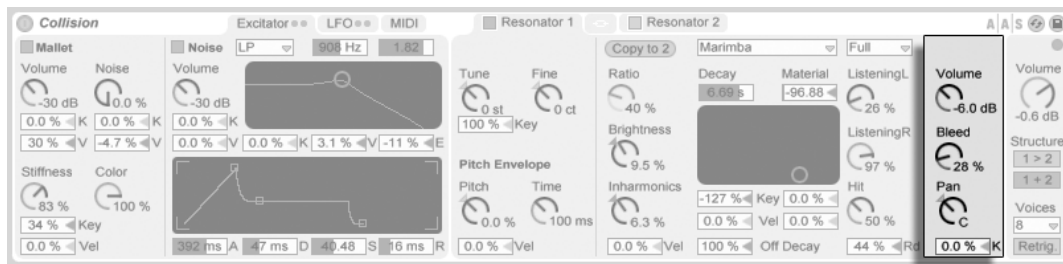

Resonator Mixer.

Each resonator has its own Volume and Pan controls. Pan can also be modulated by note pitch via the K (Key) slider below the knob.

The Bleed control mixes a portion of the original oscillator signal with the resonated signal. At higher values, more of the original signal is applied. This is useful for restoring high frequencies, which can often be damped when the tuning or quality are set to low values.

23.2.4 LFO Tab

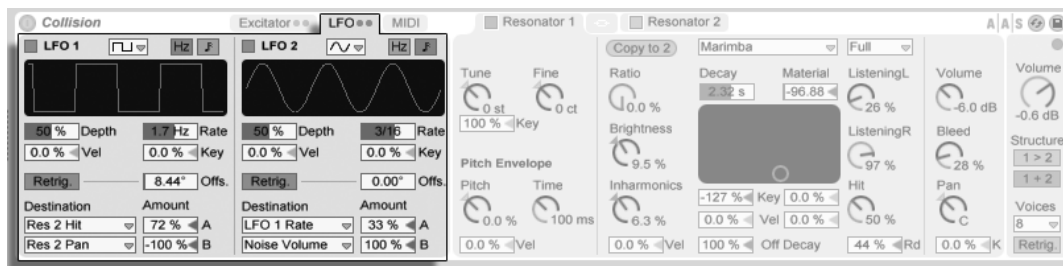

Collision's LFOs.

Collision's two independent LFOs can be used as modulation sources for a variety of excitor and resonator parameters, which are selectable in the Destination choosers. Additionally, they can modulate each other.

The LFO 1 and LFO 2 switches toggle the respective LFO on and off, while the waveform chooser determines the wave shape. The choices are sine, square, triangle, sawtooth up,

sawtooth down and two types of noise. The first noise type steps between random values while the second uses smooth ramps.

The switch next to the waveform chooser toggles the LFO's rate between frequency in Hertz and tempo-synced beat divisions.

Depth sets the overall intensity of the LFO, while Rate adjusts its speed. The sliders below these parameters allow for additional modulations; Depth can be modulated by velocity while Rate can be modulated by note pitch.

With Retrig. enabled, triggering a note restarts the LFO with the waveform phase set by the Offset parameter. The Offset slider adjusts the phase.

Each LFO can modulate two targets, which are set via the Destination choosers. The intensity of the modulations is adjusted with the Amount sliders. Note that these modulation amounts are relative to the LFO's Depth value.

23.2.5 MIDI Tab

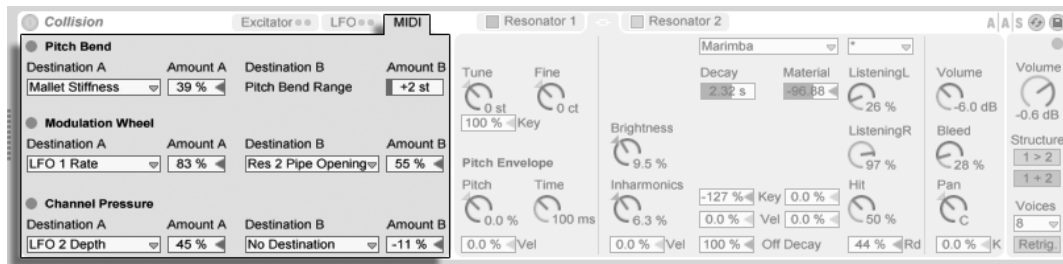

Collision's MIDI Tab.

The MIDI tab allows for a wide variety of internal MIDI mappings. The MIDI controllers *Pitch Bend*, *Modulation Wheel*, and *Aftertouch* can be mapped to two destinations each, with independent modulation intensities set via the Amount sliders. Note that pitch bend is hardwired to pitch modulation, but can still be routed to an additional target.

The Global Section

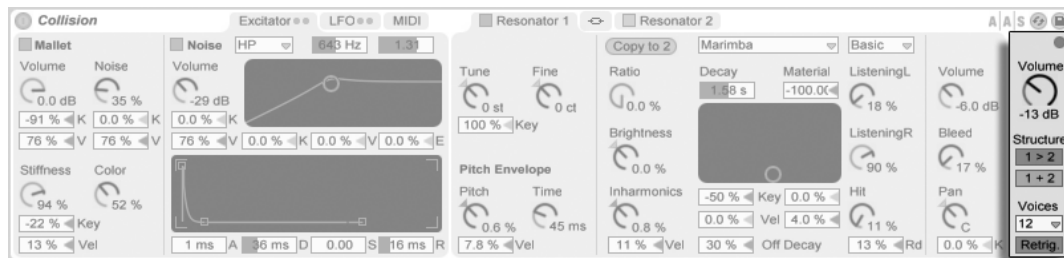

Collision's Global Section.

The global section contains the parameters that relate to the overall behavior and performance of Collision.

The Volume knob acts as Collision's master output control.

Collision contains a built-in limiter that automatically activates when the audio level is too high. This is indicated by the LED above Collision's global Volume control.

The Structure buttons determine whether Collision's resonators are arranged in *series* (1 > 2) or in *parallel* (1 + 2).

When in series, Mallet and Noise output to Resonator 1. This resonator's output is then mixed down to mono and routed to Resonator 2, as well as to its own mixer (in stereo.) Note that Resonator 1 must be turned on when using serial mode:

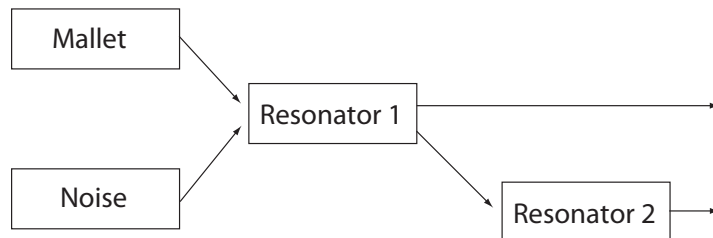

Resonators in 1 > 2 (Serial) Configuration.

In parallel mode, the output of Mallet and Noise is mixed and then sent directly to both resonators, which then output to their own mixers.

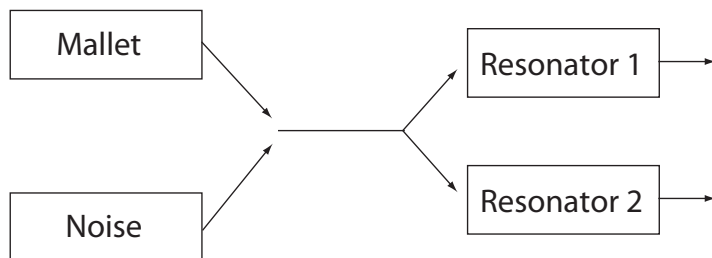

*Resonators in 1 + 2
(Parallel) Configuration.*

The Voices chooser sets the available polyphony. Since each voice that's used requires additional CPU, you may need to experiment with this chooser to find a good balance between playability and performance, particularly on older machines.

With `Retrig.` enabled, notes which are already sounding will be immediately stopped when retriggered, rather than generating an additional voice. This can be useful for keeping CPU down when working with long decay times.

23.2.6 Sound Design Tips

Although Collision has been designed to model the behavior of objects that exist in the physical world, it is important to remember that these models allow for much more flexibility than their physical counterparts. While Collision can produce extremely realistic simulations of conventional mallet instruments such as marimbas, vibraphones and glockenspiels, it is also very easy to “misuse” the instrument's parameters to produce sounds which could never be made by an acoustic instrument.

To program realistic instrument simulations, it helps to think about the chain of events that produces a sound on a mallet instrument (a marimba, for example), and then visualize those events as sections within Collision:

- a beater (Mallet) strikes a tuned bar (Resonator 1).
- the tuned bar's resonance is amplified by means of a resonating tube (Resonator 2).

Thus the conventional model consists of the Mallet excitor and the two resonators in a serial (1 > 2) configuration.

Of course, to program *unrealistic* sounds, anything goes:

- try using the Noise excicator, particularly with long envelope times, to create washy, quasi-granular textures. These parameters can also be used to simulate special acoustic effects such as bowed vibraphones or crystal glasses.
- experiment with the resonators in parallel (1 + 2) configuration.
- use the LFOs and MIDI controllers to modulate Collision's parameters.

A word of caution: in many ways, Collision's models are idealized versions of real-world objects. Consequently, it is very easy to program resonances that are much more sensitive to input than any physical resonator could be. Certain combinations of parameters can cause dramatic changes in volume. Make sure to keep output levels low when experimenting with new sounds.

23.3 Drum Machines

Drum Machines is a multisampled collection of classic drum computers, recorded and programmed by Puremagnetik. The samples are arranged into [Drum Rack](#) presets, for easy editing and performance possibilities.

The full version of Drum Machines is not included with the standard version of Live, but is a special feature available for purchase separately.

23.3.1 Drum Machines Installation

Drum Machines is installed separately from the main Live installation. To install, drag the Drum Machines Live Pack into the Live application window, either from your operating system or from Live's Browser.

After you have installed the Drum Machines Live Pack, you will need to authorize it. Further details can be found at the [Ableton website](#)¹.

¹<http://www.ableton.com/authorize>

23.3.2 Accessing the Drum Machines

After installation, the Drum Machines presets are accessed through Live's Device Browser, in exactly the same way as Live's other built-in instruments. You will find them as categorized presets within the *Drum Rack* folder. Drum Machines presets are therefore loaded just like any other device, by dragging a preset from the Browser into an empty MIDI track.

All of the Drum Machines presets are conveniently mapped to **Macro Controls** for greater expression.

Additionally, Drum Machines includes a comprehensive collection of **Live Clips**, which are installed to your Library. Loading a Live Clip to an empty MIDI track loads a combination of MIDI notes, an instrument and custom effects that you can use as a starting point for your own creative work.

23.4 Electric

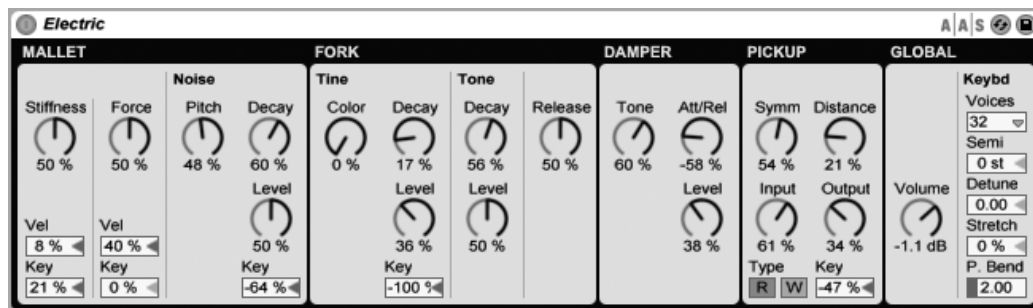

The Electric Instrument.

Electric is a software electric piano based on the classic instruments of the seventies, and developed in collaboration with Applied Acoustics Systems. Each component of these instruments has been modeled using cutting edge physical modeling technology to provide realistic and lively sounds. Physical modeling uses the laws of physics to reproduce the behavior of an object. In other words, Electric solves, in real time, mathematical equations describing how its different components function. No sampling or wavetables are used in Electric; the sound is simply calculated in real time by the CPU according to the values of each parameter. Electric is more than a simple recreation of vintage instruments; its

parameters can be tweaked to values not possible with the real instruments to get some truly amazing new sounds that still retain a warm acoustic quality.

The full version of Electric is not included with the standard version of Live, but is a special feature available for purchase separately.

23.4.1 Architecture and Interface

The mechanism of the electric piano is actually quite simple. A note played on the keyboard activates a *mallet* that hits a *fork*. The sound of that fork is then amplified by a magnetic coil *pickup* and sent to the output, very much like an electric guitar. The fork is made of two parts, called the *tine bar* and *tone bar*. The tine bar is where the mallet hits the fork while the tone bar is a tuned metal resonator, sized appropriately to produce the correct pitch. Once the fork is activated, it will continue to resonate on its own for a long time. But releasing the key applies a *damper* to the fork, which mutes it more quickly.

The Electric interface is divided into five main sections, some of which are further divided into related subsections. The first four main sections (*Mallet*, *Fork*, *Damper* and *Pickup*) correspond to the sound producing components mentioned above. The *Global* section contains parameters that affect overall behavior and performance, such as pitch bend and polyphony.

23.4.2 Mallet Section

The Mallet section contains the parameters related to the physical properties of the mallet itself, as well as how it's affected by your playing.

The Stiffness control adjusts the hardness of the mallet's striking area. Higher values simulate a harder surface, which results in a brighter sound. Lower values mean a softer surface and a more mellow sound. The Force knob adjusts the intensity of the mallet's impact on the fork. Low values simulate a soft impact while high values mean a hard impact.

The stiffness and force can also be modified by velocity and note pitch, via the Vel and Key sliders found below the knobs.

The Noise subsection simulates the impact noise caused by the mallet striking the fork. The Decay knob adjusts how long it takes for this noise to fade to silence, while the Pitch control sets the center frequency. Level adjusts the overall volume of the noise component. An additional Key scaling control adjusts how much the noise volume is determined by note pitch.

23.4.3 Fork Section

The Fork section is further divided into Tine and Tone subsections. This area is the heart of Electric's sound generating mechanism.

The Tine subsection controls the portion of the fork that is directly struck by the mallet. The Decay knob adjusts how long it takes the tine's sound to fade out while a note is held. The Color knob controls the relative amplitude of high and low partials in the tine's spectrum. Low values increase the amount of low harmonics, while higher values result in higher harmonics. The amplitude of the tine is adjusted with the Level knob. This level can be further modulated by note pitch via the Key scaling control.

The Tone subsection controls the secondary resonance of the fork. Decay and Level parameters here work in the same way as their Tine counterparts.

The Release knob applies to both the Tine and Tone areas and controls the decay time of the fork's sound after a key is released.

23.4.4 Damper Section

The metal forks in an electric piano are designed to sustain for a long time when a key is held. The mechanism that regulates this sustain is called the damper. When a key is pressed, that note's damper is moved away from its fork. When the key is released, the damper is applied to the fork again to stop it from vibrating. But the dampers themselves make a small amount of sound, both when they are applied and when they are released. This characteristic noise is modelled in Electric's Damper section.

The Tone knob adjusts the stiffness of the dampers. Turning this control to the left simulates soft dampers, which produces a mellower sound. Turning it to the right increases the

hardness of the dampers, producing a brighter sound. The overall amount of damper noise is adjusted with the Level control.

The Att/Rel knob adjusts whether or not damper noise is present when the dampers are applied to the fork or when they are released. When turned to the left, damper noise is only present during the attack phase of the note. When turned to the right, the noise is present only during the release phase. In the center, an equal amount of noise will be added during both the attack and release.

23.4.5 Pickup Section

The Pickup section simulates the behavior of the magnetic coil pickup that amplifies the sound of the resonating fork.

The R-W buttons switch between two different types of pickups. In the R position, Electric simulates electro-dynamic pickups, while W is based on an electro-static model.

The Input knob is used to adjust the amount of the fork's signal that is fed to the pickup, which in turn affects the amount of distortion applied to the overall signal. The Output knob controls the amount of signal output by the pickup section. Different combinations of these two knobs can yield very different results. For example, a low amount of input with a high amount of output will produce a cleaner sound than a high input with a low output. The output level can be further modulated by note pitch via the Key scaling control.

The Symmetry and Distance knobs adjust the physical location of the pickup in relation to the tine. Symmetry simulates the vertical position of the pickup. In the center position, the pickup is directly in front of the tine, which results in a brighter sound. Turning the knob to the left or right moves the pickup below or above the tine, respectively. Distance controls how far the pickup is from the tine. Turning the knob to the right increases the distance, while turning it to the left moves the pickup closer. Note that the sound becomes more overdriven as the pickup approaches the tine.

23.4.6 Global Section

The Global section contains the parameters that relate to the overall behavior and performance of Electric.

The Volume knob sets Electric's overall output level.

The Voices chooser sets the available polyphony. Since each voice that's used requires additional CPU, you may need to experiment with this chooser to find a good balance between playability and performance, particularly on older machines.

The Semi and Detune controls function as coarse and fine tuners. Semi transposes the entire instrument up or down in semitone increments, while the Detune slider adjusts in increments of one cent (up to a maximum of 50 cents up or down).

Stretch simulates a technique known as stretch tuning, which is a common modification made to both electric and acoustic pianos and is an intrinsic part of their characteristic sound. At 0%, Electric will play in equal temperament, which means that two notes are an octave apart when the upper note's fundamental pitch is exactly twice the lower note's. But because the actual resonance behavior of a vibrating tine or string differs from the theoretical model, equal temperament tends to sound "wrong" on pianos. Stretch tuning attempts to correct this by sharpening the pitch of upper notes while flattening the pitch of lower ones. The result is a more brilliant sound. Negative values simulate "negative" stretch tuning; upper notes become flatter while lower notes become sharper.

P Bend sets the range in semitones of pitch bend modulation.

23.5 External Instrument

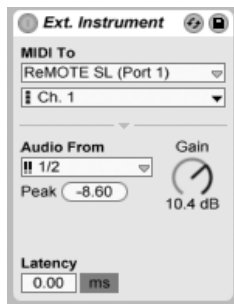

The External Instrument.

The External Instrument device is not an instrument itself, but rather a routing utility that

allows you to easily integrate external (hardware) synthesizers, ReWire devices and multi-timbral plug-ins into your projects. It sends MIDI out and returns audio.

The two MIDI To choosers select the output to which the device will send MIDI data. The top chooser selects either a [physical MIDI port](#), a [ReWire slave](#) destination or a multi-timbral plug-in. If you select a MIDI port (for use with an external synthesizer), the second chooser's options will be MIDI channel numbers. If you've chosen a ReWire slave such as Reason as your routing target, the choices will be the specific devices available in the slave project:



*ReWire Options Shown
in the Routing Choosers.*

If another track in your set contains a multi-timbral plug-in, you can select this track in the top chooser. In this case, the second chooser allows you to select a specific MIDI channel in the plug-in.

The Audio From chooser provides options for returning the audio from the hardware synth, plug-in, or ReWire device. If you're routing to a hardware synth, use this chooser to select the ports on your audio interface that are connected to the output of your synth. The available choices you'll have will depend on the settings in the [Audio Preferences](#).

If you're routing to a ReWire slave, the Audio From chooser will list all of the audio channels available in the slave. Select the audio channel that corresponds to the instrument to which you are sending MIDI. If you're routing to a multi-timbral plug-in on another track in your Live Set, the Audio From chooser will list the auxiliary outputs in the plug-in. Note that the main outputs will be heard on the track that contains the instrument.

The Gain knob adjusts the audio level coming back from the sound source. This level should be set carefully to avoid clipping.

Since external devices can introduce latency that Live cannot automatically detect, you can manually compensate for any delays by adjusting the Latency slider. The button next to this

slider allows you to set your latency compensation amount in either milliseconds or samples. If your external device connects to Live via a digital connection, you will want to adjust your latency settings in samples, which ensures that the number of samples you specify will be retained even when changing the sample rate. If your external device connects to Live via an analog connection, you will want to adjust your latency settings in milliseconds, which ensures that the amount of time you specify will be retained when changing the sample rate. Note that adjusting in samples gives you finer control, so even in cases when you're working with analog devices, you may want to "fine tune" your latency in samples in order to achieve the lowest possible latency. In this case, be sure to switch back to milliseconds before changing your sample rate. Any latency introduced by devices within Live will be compensated for automatically, so the latency slider will be disabled when using the External Instrument Device to route internally. Latency adjustments when routing to ReWire devices will probably not be necessary, as most ReWire-enabled programs also compensate automatically. But if you feel that something is "off" in the timing of your set, try adjusting this slider.

Note: If the [Delay Compensation](#) option is unchecked in the Options menu, the Latency slider is disabled.

For more detailed information about routing scenarios with the External Instrument device, please see the [Routing and I/O](#) chapter.

23.6 Impulse

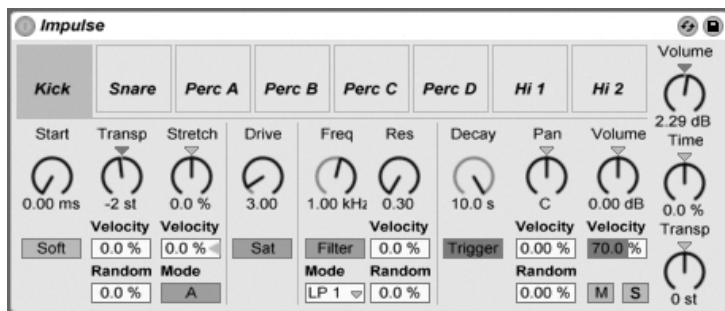

The Impulse Instrument.

Impulse is a drum sampler with complex modulation capabilities. The eight drum samples

loaded into Impulse's sample slots can be time-stretched, filtered and processed by envelope, saturation, pan and volume components, nearly all of which are subject to random and velocity-based modulation.

23.6.1 Sample Slots

Drag and drop samples into any of Impulse's sample slots from the Browser or the Session and Arrangement Views. Alternatively, each sample slot features a Hot-Swap button for [hot-swapping samples](#). Loaded samples can be deleted with your computer keyboard's  or [Delete](#) key.

Imported samples are automatically mapped onto your MIDI keyboard, providing that it is plugged in and acknowledged by Live. C3 on the keyboard will trigger the leftmost sample, and the other samples will follow suit in the octave from C3 to C4. Impulse's eight slots will appear labeled in the [MIDI Editor's key tracks](#) when the Fold button is active, even if the given key track is void of MIDI notes. Mapping can be transposed from the default by applying a [Pitch device](#), or it can be rearranged by applying a [Scale device](#).

Each of the eight samples has a proprietary set of parameters, located in the area below the sample slots and visible when the sample is clicked. Adjustments to sample settings are only captured once you hit a new note – they do not affect currently playing notes. Note that this behavior also defines how Impulse reacts to parameter changes from clip envelopes or automation, which are applied once a new note starts. If you want to achieve continuous changes as a note plays, you may want to use the [Simpler](#).

Slot 8's parameters also include a Link button, located in the lower left corner, which links slot 8 with slot 7. Linking the two slots allows slot 7's activation to stop slot 8's playback, and vice versa. This was designed with a specific situation in mind (but can, of course, be used for other purposes): Replicating the way that closed hi-hats will silence open hi-hats.

Each slot can be played, soloed, muted or hot-swapped using controls that appear when the mouse hovers over it.

23.6.2 Start, Tune and Stretch

The Start control defines where Impulse begins playing a sample, and can be set up to 100 ms later than the actual sample beginning. The Transposition control adjusts the transposition of the sample by +/- 48 semitones, and can be modulated by incoming note velocity or a random value, as set in the appropriate fields.

The Stretch control has values from -100 to 100 percent. Negative values will shorten the sample, and positive values will stretch it. Two different stretching algorithms are available: Mode A is ideal for low sounds, such as toms or bass, while Mode B is better for high sounds, such as cymbals. The Stretch value can also be modulated by MIDI note velocity.

23.6.3 Filter

The Filter section offers a broad range of filter types, each of which can impart different sonic characteristics onto the sample by removing certain frequencies. The Frequency control defines where in the harmonic spectrum the filter is applied; the Resonance control boosts frequencies near that point. Filter Frequency can be modulated by either a random value or by MIDI note velocity.

23.6.4 Saturator and Envelope

The Saturator gives the sample a fatter, rounder, more analog sound, and can be switched on and off as desired. The Drive control boosts the signal and adds distortion. Coincidentally, this makes most signals much louder, and should usually be compensated for by lowering the sample's volume control. Extreme Drive settings on low-pitched sounds will produce the typical, overdriven analog synth drum sounds.

The envelope can be adjusted using the Decay control, which can be set to a maximum of 60 seconds. Impulse has two decay modes: Trigger Mode allows the sample to decay with the note; Gate Mode forces the envelope to wait for a note off message before beginning the decay. This mode is useful in situations where you need variable decay lengths, as is the case with hi-hat cymbal sounds.

23.6.5 Pan and Volume

Each sample has Volume and Pan controls that adjust amplitude and stereo positioning, respectively. Both controls can be modulated: Pan by velocity and a random value, and Volume by velocity only.

23.6.6 Global Controls

The parameters located to the right of the sample slots are global controls that apply to all samples within Impulse's domain. Volume adjusts the overall level of the instrument, and Pitch adjusts the transposition of all samples. The Time control governs the time-stretching and decay of all samples, allowing you to morph between short and stretched drum sounds.

23.6.7 Individual Outputs

When a new instance of Impulse is dragged into a track, its signal will be mixed with those of the other instruments and effects feeding the audio chain of the track. It can oftentimes make more sense to isolate the instrument or one of its individual drum samples, and send this signal to a separate track. Please see [the Routing chapter](#) to learn how to accomplish this for Impulse's overall signal or for Impulse's individual sample slots.

23.7 Latin Percussion

Latin Percussion is a multisampled library of acoustic percussion instruments from the worlds of Brazilian, Afro-Cuban and African music. Developed in collaboration with e-instruments, the collection consists of multi-articulation kits and instrument group presets, programmed as [Drum Racks](#) for easy editing and performance possibilities. In addition to the instruments, Latin Percussion comes with a collection of Live Sets that contain carefully programmed MIDI patterns in a variety of traditional styles.

The full version of Latin Percussion is not included with the standard version of Live, but is a special feature available for purchase separately.

23.7.1 Latin Percussion Installation

Latin Percussion is installed separately from the main Live installation. To install, drag the Latin Percussion Live Pack into the Live application window, either from your operating system or from Live's Browser.

After you have installed Latin Percussion, you will need to authorize it. Further details can be found at the [Ableton website](http://www.ableton.com/authorize)².

23.7.2 Accessing the Latin Percussion Presets

After installation, the Latin Percussion presets are accessed through Live's Device Browser, in exactly the same way as Live's other built-in instruments. You will find them in the *Latin Percussion* folder within the *Drum Rack* folder. Latin Percussion presets are therefore loaded just like any other device, by dragging a preset from the Browser into an empty MIDI track.

The "Latin Percussion Kit" presets load a complete collection of instruments. Individual instrument groups are available in the *preset folders*.



Preset Folders.

23.7.3 Modifying the Drum Racks

All of the Latin Percussion presets are conveniently mapped to [Macro Controls](#) for greater expression. These include controls for tuning, room ambience and volume envelope.

From the Drum Rack's [Pad View](#), you can easily replace individual instruments or instrument groups within the kit. For example, to swap one set of congas for another, use the Browser

²<http://www.ableton.com/authorize>

to navigate to the selected conga preset folder. Then drag the entire folder to the Drum Rack's pad view. This will replace all of the currently loaded conga components, leaving all other pads alone. You can also unfold these preset folders to access individual instruments within.

Latin Percussion also includes a collection of [Live Sets](#), which are installed to your Library's "Clips" folder. These Sets load clips that combine MIDI notes and a percussion kit that you can use as a starting point for your own creative work.

23.8 Operator

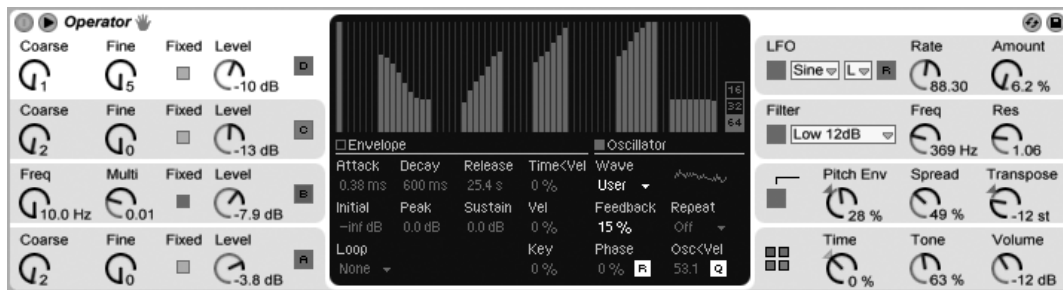

The Operator Instrument.

Operator is an advanced and flexible synthesizer that combines the concept of "frequency modulation" (FM) with classic subtractive and additive synthesis. It utilizes four multi-waveform oscillators that can modulate each other's frequencies, creating very complex timbres from a limited number of objects. Operator includes a filter section, an LFO and global controls, as well as individual envelopes for the oscillators, filter, LFO and pitch.

With the release of Live 8, Operator has been dramatically overhauled with powerful new features. Despite this, the interface is mostly unchanged, and presets and Sets that were made with earlier versions of Operator are fully compatible with this update.

The full version of Operator is not included with the standard version of Live, but is a special feature available for purchase separately.

23.8.1 General Overview

The interface of Operator consists of two parts: the *display* surrounded on either side by the *shell*. The shell offers the most important parameters in a single view and is divided into eight sections. On the left side, you will find four oscillator sections, and on the right side from top to bottom, the LFO, the filter section, the pitch section and the global parameters. If you change one of the shell parameters, the display in the center will automatically show the details of the relevant section. When creating your own sounds, for example, you can conveniently access the level and frequency of all oscillators at once via the shell, and then adjust each individual oscillator's envelope, waveform and other parameters in its display.

Operator can be folded with the triangular button at its upper left. This is convenient if you do not need to access the display details.

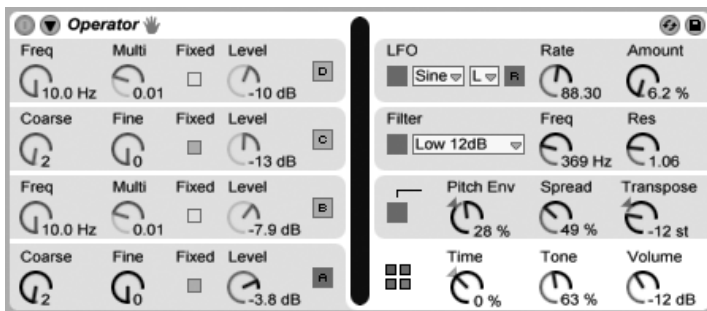

Operator Folded.

Each of Operator's oscillators can either output its signal directly or use its signal to modulate another oscillator. Operator offers eleven predefined *algorithms* that determine how the oscillators are connected. An algorithm is chosen by clicking on one of the structure icons in the global display, which will appear if the bottom right (global) section of the shell is selected. Signals will flow from top to bottom between the oscillators shown in an algorithm icon. The algorithm selector can be mapped to a MIDI controller, automated, or modulated in real time, just like any other parameter.

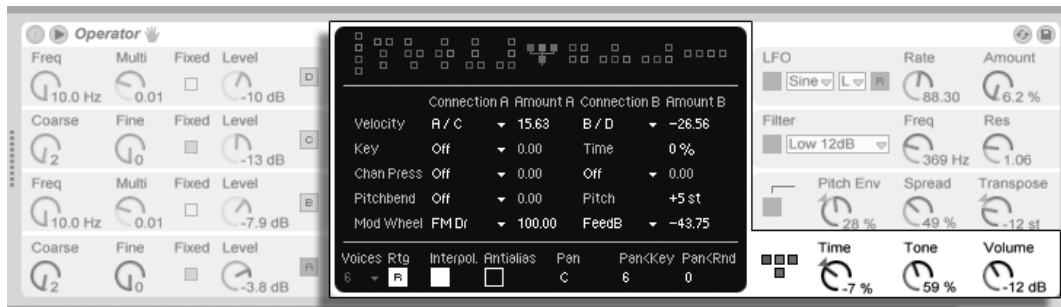

Operator's Global Display.

Typically, FM synthesis makes use of pure sine waves, creating more complex waveforms via modulation. However, in order to simplify sound design and to create a wider range of possible sounds, we designed Operator to produce a variety of other waveforms, including two types of noise. You can also draw your own waveforms via a partial editor. The instrument is made complete with an LFO, a pitch envelope and a filter section. Note that lots of “classic” FM synthesizers create fantastic sounds without using filters at all, so we suggest exploring the possibilities of FM without the filter at first, and adding it later if necessary.

Operator will keep you busy if you want to dive deep into sound design! If you want to break the universe apart completely and reassemble it, you should also try modulating Operator's controls with [clip envelopes](#) or [track automation](#).

23.8.2 Oscillator Section

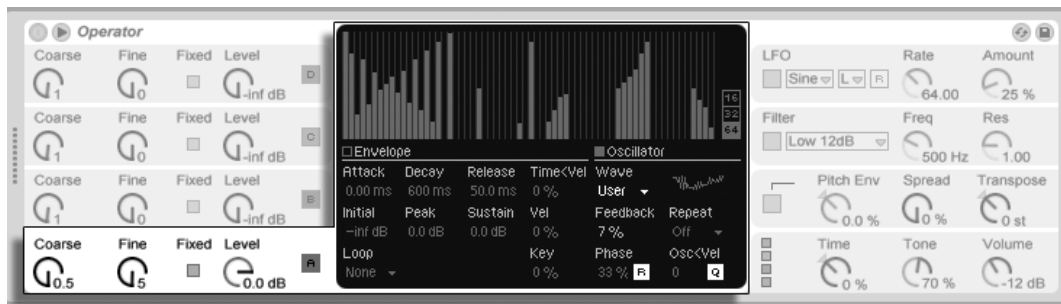

Oscillator A's Display and Shell Parameters.

Built-in Waveforms



The oscillators come with a built-in collection of basic waveform types – sine, sawtooth, square, triangle and noise – which are selected from the Wave chooser in the individual oscillator displays. The first of these waveforms is a pure, mathematical sine wave, which is usually the first choice for many FM timbres. We also added “Sine 4 Bit” and “Sine 8 Bit” to provide the retro sound adored by C64 fans, and “Saw D” and “Square D” digital waveforms, which are especially good for digital bass sounds. The square, triangle and sawtooth waveforms are resynthesized approximations of the ideal shape. The numbers included in the displayed name (e.g., “Square 6”) define how many harmonics are used for the resynthesis. Lower numbers sound mellower and are less likely to create *aliasing* when used on high pitches. There are also two built-in noise waveforms. The first, “Noise Looped,” is a looping sample of noise. For truly random noise, choose “Noise White.”

User Waveforms



The “User” entry in the Wave chooser allows you to create your own waveforms by drawing the amplitudes of the oscillator’s harmonics. You can also select one of the built-in waveforms and then edit it in the same way. The small display next to the Wave chooser gives a realtime overview of your waveform.



When your mouse is over the Oscillator display area, the cursor will change to a pencil. Drawing in the display area then raises or lowers the amplitudes of the harmonics. As you adjust the amplitudes, the Status Bar will show the number of the harmonic you’re adjusting as well as its amplitude. Holding  and dragging will constrain horizontal mouse movement, allowing you to adjust the amplitude of only one harmonic at a time.

You can switch between editing the first 16, 32 or 64 harmonics via the switches to the right of the display. Higher harmonics can be generated by repeating the drawn partials with a gradual fadeout, based on the settings in the Repeat chooser. Low Repeat values result in a brighter sound, while higher values result in more high-end roll-off and a more prominent fundamental. With Repeat off, partials above the 16th, 32nd or 64th harmonic are truncated.

The  (PC) /   (Mac) context menu on the harmonics display offers options for editing only the even or odd harmonics. This is set to “All” by default. The context menu also

offers an option to toggle Normalize on or off. When enabled, the oscillator's overall output level is maintained as you draw additional harmonics. When disabled, additional harmonics add additional level. Note that the volume can become *extremely* loud if Normalize is off.

You can export your waveform in .ams format to the Library/Samples/Waveforms folder via an option in the  (PC) /   (Mac) context menu. Ams files can be imported back into Operator by dragging them from the Browser onto one of the oscillator's display areas. Ams files can also be loaded into [Simpler](#) or [Sampler](#).

Hint: Both the built-in and user waveforms can be copied and pasted from one oscillator to another using the  (PC) /   (Mac) context menu.

More Oscillator Parameters

The frequency of an oscillator can be adjusted in the shell with its Coarse and Fine controls. An oscillator's frequency usually follows that of played notes, but for some sounds it might be useful to set one or more oscillators to fixed frequencies. This can be done for each individual oscillator by activating the Fixed option. This allows the creation of sounds in which only the timbre will vary when different notes are played, but the tuning will stay the same. Fixed Mode would be useful, for example, in creating live drum sounds. Fixed Mode also allows producing very low frequencies down to 0.1 Hz. Note that when Fixed Mode is active, the frequency of the oscillator is controlled in the shell with the Frequency (Freq) and Multiplier (Multi) controls.

Operator includes a special Osc<Vel control for each oscillator that allows altering frequency as a function of velocity. This feature can be very useful when working with sequenced sounds in which the velocity of each note can be adjusted carefully. Part of this functionality is the adjacent Q (Quantize) button. If this control is activated, the frequency will only move in whole numbers, just as if the Coarse control were being manually adjusted. If quantize is not activated, the frequency will be shifted in an unquantized manner, leading to detuned or inharmonic sounds (which very well could be exactly what you want...).

The amplitude of an oscillator depends on the Level setting of the oscillator in the shell and on its [envelope](#), which is shown and edited when the Envelope display is visible. The envelopes can also be modified by note velocity and note pitch with the Vel and Key parameters available in the Envelope section of each oscillator's display.

The phase of each oscillator can be adjusted using the Phase control in its display. With the R (Retrigger) button enabled, the waveform restarts at the same position in its phase each time a note is triggered. With R disabled, the oscillator is free-running.

As explained [earlier](#) oscillators can modulate each other when set up to do so with the global display's algorithms. When an oscillator is modulating another oscillator, two main properties define the result: the amplitude of the modulating oscillator and the frequency ratio between both oscillators. Any oscillator that is not modulated by another oscillator can modulate itself, via the Feedback parameter in its display.

Aliasing

Aliasing distortion is a common side effect of all digital synthesis and is the result of the finite sample rate and precision of digital systems. It mostly occurs at high frequencies. FM synthesis is especially likely to produce this kind of effect, since one can easily create sounds with lots of high harmonics. This also means that more complex oscillator waveforms, such as "Saw 32," tend to be more sensitive to aliasing than pure sine waves. Aliasing is a two-fold beast: A bit of it can be exactly what is needed to create a cool sound, yet a bit too much can make the timbre unplayable, as the perception of pitch is lost when high notes suddenly fold back into arbitrary pitches. Operator minimizes aliasing by working in a high-quality Antialias mode. This is on by default for new patches, but can be turned off in the global section. The Tone parameter in the global section also allows for controlling aliasing. Its effect is sometimes similar to a lowpass filter, but this depends on the nature of the sound itself and cannot generally be predicted. If you want to familiarize yourself with the sound of aliasing, turn Tone up fully and play a few very high notes. You will most likely notice that some notes sound completely different from other notes. Now, turn Tone down and the effect will be reduced, but the sound will be less bright.

23.8.3 LFO Section

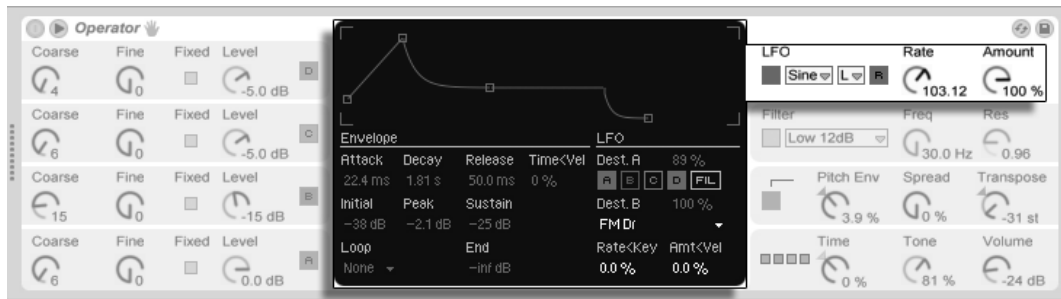

Operator's LFO Parameters.

The LFO in Operator can practically be thought of as a fifth oscillator. It runs at audio rates, and it modulates the frequency of the other oscillators. It is possible to switch LFO modulation on or off for each individual oscillator (and the filter) using the Dest. A buttons in the LFO's display. The intensity of the LFO's modulation of these targets can be adjusted by the Dest. A slider. The LFO can also be turned off entirely if it is unused.

The Dest. B chooser allows the LFO to modulate an additional parameter. The intensity of this modulation is determined by the Dest. B slider.

The LFO offers a choice of classic LFO waveforms, sample and hold (S&H), and noise. Sample and hold uses random numbers chosen at the rate of the LFO, creating the random steps useful for typical retro-futuristic sci-fi sounds. The noise waveform is simply bandpass-filtered noise.

Tip: FM synthesis can be used to create fantastic percussion sounds, and using the LFO with the noise waveform is the key to great hi-hats and snares.

The frequency of the LFO is determined by the LFO Rate control in the shell, as well as the low/high/sync setting of the adjacent LFO Range chooser. The frequency of the LFO can follow note pitch, be fixed or be set to something in between. This is defined by the Rate<Key parameter in the LFO's display. With the R (Retrigger) button enabled, the LFO restarts at the same position in its phase each time a note is triggered. With R disabled, the LFO is free-running.



The overall intensity of the LFO is set by the LFO Amount control in the shell. This parameter scales both the Dest. A and B amounts and can be modulated by note velocity via the

display's Amt<Vel control. The LFO's intensity is also affected by its **envelope**.

23.8.4 Envelopes

Operator has seven envelopes: one for each oscillator, a filter envelope, a pitch envelope and an envelope for the LFO. All envelopes feature some special looping modes. Additionally, the filter and pitch envelopes have adjustable slopes.

Each oscillator's volume envelope is defined by six parameters: three rates and three levels. A rate is the time it takes to go from one level to the next. For instance, a typical pad sound starts with the *initial* level “-inf dB” (which is silence), moves with an *attack* rate to its *peak* level, moves from there to the *sustain* level with a *decay* rate, and then finally, after note-off occurs, back to “-inf dB” at the *release* rate. Operator's display provides a good overview of the actual shape of any particular envelope and lets you directly adjust the curve by clicking on a breakpoint and dragging. The breakpoints retain their selection after clicking, allowing them to be adjusted with the keyboard's cursor keys, if desired.

Hint: Envelope shapes can be copied and pasted from one oscillator to another in Operator using the  (PC) /   (Mac) context menu.

As mentioned above, the filter and pitch envelopes also have adjustable slopes. Clicking on the diamonds between the breakpoints allows you to adjust the slope of the envelope segments. Positive slope values cause the envelope to move quickly at the beginning, then slower. Negative slope values cause the envelope to remain flat for longer, then move faster at the end. A slope of zero is linear; the envelope will move at the same rate throughout the segment.

With FM synthesis, it is possible to create spectacular, endless, permuting sounds; the key to doing this is *looping envelopes*. Loop Mode can be activated in the lower left corner of the display. If an envelope in Operator is in Loop Mode and reaches sustain level while the note is still being held, it will be retriggered. The rate for this movement is defined by the Loop Time parameter. (Note that envelopes in Loop Mode can loop very quickly and can therefore be used to achieve effects that one would not normally expect from an envelope generator.)

While Loop Mode is good for textures and experimental sounds, Operator also includes Beat and Sync Modes, which provide a simple way of creating rhythmical sounds. If set to Beat

Mode, an envelope will restart after the beat time selected from the Repeat chooser. In Beat Mode, the repeat time is defined in fractions of song time, but notes are not quantized. If you play a note a bit out of sync, it will repeat perfectly but stay out of sync. In Sync Mode however, the first repetition is quantized to the nearest 16th note and, as a result, all following repetitions are synced to the song tempo. Note that Sync Mode only works if the song is playing, and otherwise it will behave like Beat Mode.

Note: To avoid the audible clicks caused by restarting from its *initial level*, a looped envelope will restart from its *actual level* and move with the set attack rate to peak level.

There is also a mode called Trigger that is ideal for working with percussive sounds. In this mode, note off is ignored. This means that the length of time a key is held has no effect on the length of the sound.

The rates of all the envelopes in Operator can be scaled in unison by the Time control in the global section of the shell. Note that beat-time values in Beat and Sync Modes are not influenced by the global Time parameter. Envelope rates can be further modified by note pitch, as dictated by the Time<Key parameter in the global section's display. The rate of an individual envelope can also be modified by velocity using the Time<Vel parameter. These modulations in conjunction with the loop feature can be used to create very, very complex things...

The pitch envelope can be turned on or off for each individual oscillator and for the LFO using the Destination A-D and LFO buttons in its display. The intensity of this envelope's modulation of these targets can be adjusted by the Dest. A slider and the envelope can be turned off altogether via the switch in the pitch section of the shell.

Like the LFO, the pitch envelope can modulate an additional parameter as chosen by the Dest. B chooser. The intensity of this modulation is determined by the Amt. B slider and the main Pitch Env value.

The pitch and filter envelopes each have an additional parameter called *End*, which determines the level the envelope will move to after the key is released. The rate of this envelope segment is determined by the release time.

Tip: If the pitch envelope is only applied to the LFO and is looping, it can serve as another LFO, modulating the rate of the first. And, since the envelope of the LFO itself can loop, it can serve as a third LFO modulating the intensity of the first!

23.8.5 Filter Section

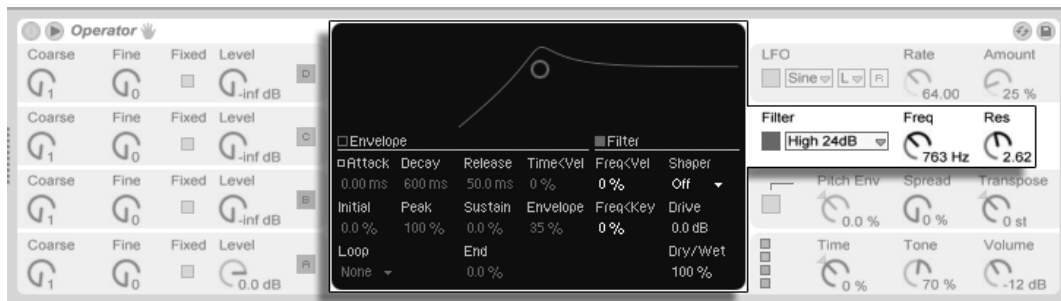



Operator's Filter Section.

Operator's filters can be very useful for modifying the sonically rich timbres created by the oscillators. And, since the oscillators also provide you with the classic waveforms of analog synthesizers, you can very easily build a subtractive synthesizer with them.

The filter section offers 14 different filter types including multiple varieties of lowpass, bandpass, highpass and notch filters. The 12 and 24 dB modes refer to the amount of attenuation. The 24 dB modes attenuate the filtered frequencies to a much greater degree than the 12 dB types, and are commonly used in the creation of bass patches. The SVF (state-variable filter) modes are 12 dB types but with a different architecture. They will self-oscillate as their resonance is increased. The Ladder modes have 24 dB slopes and are based on the filters found in some classic analog synthesizers.

The Envelope and Filter buttons in the filter section's display area toggle between showing the filter envelope and its frequency response. Filter cutoff frequency and resonance can be adjusted in the shell or by dragging the filter response curve in the display area. Filter frequency can also be modulated by note velocity, note pitch, the LFO and the **filter envelope**. The Freq<Vel, Freq<Key and Envelope controls in the filter's display set these three functions, respectively.

Tip: The  (PC) /  (Mac) context menu on the Frequency knob contains an entry called "Play by Key." This automatically configures the filter for optimal key tracking by setting Freq<Key to 100% and setting the cutoff to 466 Hz.

The filter's signal can be routed through a waveshaper, whose curve type can be selected via the Shaper chooser. The Drive slider boosts or attenuates the signal level being sent to the waveshaper, while the overall balance between the dry and processed signals can be

adjusted with the Dry/Wet control. With this set to 0%, the shaper and drive parameters are bypassed.

23.8.6 Global Controls

The global section contains parameters that affect Operator's overall behavior. Additionally, the global display area provides a comprehensive set of modulation routing controls.

The maximum number of Operator voices (notes) playing simultaneously can be adjusted with the Voices parameter in the global display. Ideally, one would want to leave this setting high enough so that no voices would be turned off while playing, however a setting between 6 and 12 is usually more realistic when considering [CPU power](#).

Tip: Some sounds should play monophonically by nature, which means that they should only use a single voice. (A flute is a good example.) In these cases, you can set Voices to 1. If Voices is set to 1, another effect occurs: Overlapping voices will be played legato, which means that the envelopes will not be retriggered from voice to voice, and only pitch will change.

A global Volume control for the instrument can be found in the global section of the shell, and a Pan control is located in the global section's display. Pan can be modulated by a random factor or by note pitch, using the adjacent Rnd and Key controls, respectively.

The center of the global display allows for a wide variety of internal MIDI mappings. The MIDI controllers *Velocity*, *Key*, *Aftertouch*, *Pitch Bend* and *Mod Wheel* can be mapped to two destinations each, with independent modulation intensities set via the Amount sliders. Note that Time<Key and pitch bend range have fixed assignments, although both modulation sources can still be routed to an additional target. For more information about the available modulation options, see [the complete parameter list](#).

23.8.7 Glide and Spread

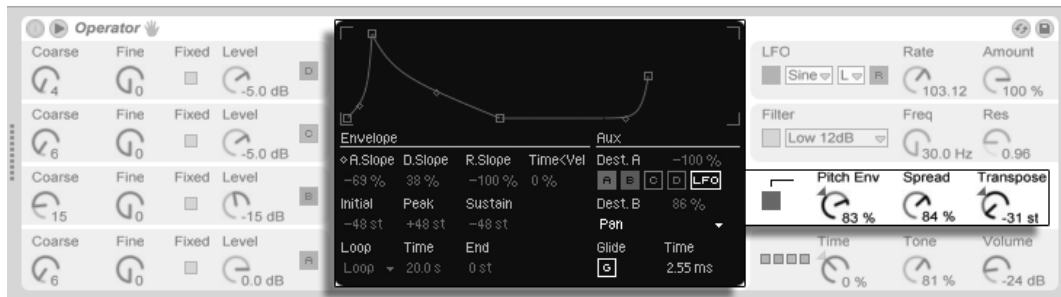

Operator's Pitch Section.

Operator includes a polyphonic glide function. When this function is activated, new notes will start with the pitch of the last note played and then slide gradually to their own played pitch. Glide can be turned on or off and adjusted with the Glide Time control in the pitch display.

Operator also offers a special Spread parameter that creates a rich stereo chorus by using two voices per note and panning one to the left and one to the right. The two voices are detuned, and the amount of detuning can be adjusted with the Spread control in the pitch section of the shell.

Tip: Whether or not spread is applied to a particular note depends upon the setting of the Spread parameter during the note-on event. To achieve special effects, you could, for instance, create a sequence where Spread is 0 most of the time and turned on only for some notes. These notes will then play in stereo, while the others will play mono.

The pitch section also contains a global Transpose knob.

23.8.8 Strategies for Saving CPU Power

If you want to save CPU power, turn off features that you do not need or reduce the number of voices. Specifically, turning off the filter or the LFO if they do not contribute to the sound will save CPU power.

For the sake of saving CPU resources, you will also usually want to reduce the number of voices to something between 6 and 12, and carefully use the Spread feature. The

Interpolation and Antialias modes in the global display can also be turned off to conserve CPU resources.

Note that turning off the oscillators will not save CPU power.

23.8.9 Finally...

Operator is the result of an intense preoccupation with FM synthesis and a love and dedication to the old hardware FM synthesizers, such as the Yamaha SY77, the Yamaha TX81Z and the NED Synclavier II. FM synthesis was first explored musically by the composer and computer music pioneer John Chowning in the mid-1960s. In 1973, he and Stanford University began a relationship with Yamaha that led to one of the most successful commercial musical instruments ever, the DX7.

John Chowning realized some very amazing and beautiful musical pieces based on a synthesis concept that you can now explore yourself simply by playing with Operator in Live.

We wish you loads of fun with it!

23.8.10 The Complete Parameter List

The function of each Operator parameter is explained in the forthcoming sections. Remember that you can also access explanations of controls in Live (including those belonging to Operator) directly from the software by placing the mouse over the control and reading the text that appears in the [Info View](#). Parameters in this list are grouped into sections based on where they appear in Operator.

Global Shell and Display

Time – This is a global control for all envelope rates.

Tone – Operator is capable of producing timbres with very high frequencies, which can sometimes lead to aliasing artifacts. The Tone setting controls the high frequency content of sounds. Higher settings are typically brighter but also more likely to produce aliasing.

Volume – This sets the overall volume of the instrument.

Algorithm – An oscillator can modulate other oscillators, be modulated by other oscillators, or both. The algorithm defines the connections between the oscillators and therefore has a significant impact on the sound that is created.

Voices – This sets the maximum number of notes that can sound simultaneously. If more notes than available voices are requested, the oldest notes will be cut off.

Retrigger (R) – When enabled, notes that are enabled will be retriggered, rather than generating an additional voice.

Interpolation – This toggles the interpolation algorithm of the oscillators and the LFO. If turned off, some timbres will sound more rough, especially the noise waveform. Turning this off will also save some CPU power.

Antialias – This toggles Operator's high-quality antialias mode, which helps to minimize high-frequency distortion. Disabling this modes reduces the CPU load.

Time<Key – The rates of all envelopes can be controlled by note pitch. If the global Time<Key parameter is set to higher values, the envelopes run faster when higher notes are played.

Pitch Bend Range (PB Range) – This defines the effect of MIDI pitch bend messages.

Pan – Use this to adjust the panorama of each note. This is especially useful when modulated with clip envelopes.

Pan<Key (Key) – If Pan<Key is set to higher values, low notes will pan relatively more to the left channel, and higher notes to the right. Typically this is used for piano-like sounds.

Pan<Random (Rnd) – This defines the extent to which notes are randomly distributed between the left and right channels.

Modulation Targets

These modulation targets are available as MIDI routing destinations in the global display, and also as modulation targets for the LFO and pitch envelope.

Off – Disabled this controller's modulation routing.

OSC Volume A-D – Modulates the volume of the selected oscillator.

OSC Crossfade A/C – Crossfades the volumes of the A and C oscillators based on the value of the modulation source.

OSC Crossfade B/D – Crossfades the volumes of the B and D oscillators based on the value of the modulation source.

OSC Feedback – Modulates the amount of feedback for all oscillators. Note that feedback is only applied to oscillators that are not modulated by other oscillators.

FM Drive – Modulates the volume of all oscillators which are modulating other oscillators, thus changing the timbre.

Filter Frequency – Modulates the cutoff frequency of the filter.

Filter Q – Modulates the resonance of the filter.

Filter Envelope Amount – Modulates the filter's envelope intensity.

Shaper Drive – Modulates the amount of gain applied to the filter's waveshaper.

LFO Rate – Modulates the rate of the LFO.

LFO Amount – Modulates the intensity of the LFO.

Pitch Envelope Amount – Modulates the intensity of the pitch envelope.

Volume – Modulates Operator's global output volume.

Panorama – Modulates the position of Operator's output in the stereo field.

Tone – Modulates the global Tone parameter.

Time – Modulates the global control for all envelope rates.

Pitch Shell and Display

Pitch Envelope On – This turns the pitch envelope on and off. Turning it off if it is unused saves some CPU power.

Pitch Envelope Amount (Pitch Env) – This sets the overall intensity of the pitch envelope. A value of 100% means that the pitch change is exactly defined by the pitch envelope's levels. A value of -100% inverts the sign of the pitch envelope levels.

Spread – If Spread is turned up, the synthesizer uses two detuned voices per note, one each on the left and right stereo channels, to create chorusing sounds. Spread is a very CPU-intensive effect.

Transpose – This is the global transposition setting for the instrument. Changing this parameter will affect notes that are already playing.

Pitch Envelope Rates<Velocity (Time<Vel) – This parameter exists for filter, pitch, LFO and volume envelopes. It is therefore listed in the [section on envelopes](#).

Glide (G) – With Glide on, notes will slide from the pitch of the last played note to their played pitch. Note that all envelopes are not retriggered in this case if notes are being played legato.

Glide Time (Time) – This is the time it takes for a note to slide from the pitch of the last played note to its final pitch when Glide is activated. This setting has no effect if Glide is not activated.

Pitch Envelope to Osc (Destination A-D) – The pitch envelope affects the frequency of the respective oscillator if this is turned on.

Pitch Envelope to LFO (Destination LFO) – The pitch envelope affects the frequency of the LFO if this is turned on.

Pitch Envelope Amount A – This sets the intensity of the pitch envelope's modulation of the oscillators and LFO.

Pitch Envelope Destination B – This sets the second modulation destination for the pitch envelope.

Pitch Envelope Amount B – This sets the intensity of the pitch envelope's modulation of the secondary target.

Filter Shell and Display

Filter On – This turns the filter on and off. Turning it off when it is unused saves CPU power.

Filter Type – This chooser selects one of 14 filter types, including a variety of lowpass, highpass, bandpass and notch filters. The filter names imply the part of the spectrum they affect. A notch filter passes everything apart from its center frequency and is more audible

with low resonance settings. The 24 dB filter modes attenuate the filtered frequencies to a much greater degree than the 12 dB modes. The Ladder and SVF filters provide additional filter architectures.

Filter Frequency (Freq) – This defines the center or cutoff frequency of the filter. Note that the resulting frequency may also be modulated by note velocity and by the filter envelope.

Filter Resonance (Res) – This defines the resonance around the filter frequency of the lowpass and highpass filters, and the width of the bandpass and notch filters.

Envelope / Filter Switches – These switches toggle the display between the filter's envelope and its frequency response.

Filter Frequency<Velocity (Freq<Vel) – Filter frequency is modulated by note velocity according to this setting.

Filter Frequency<Key (Freq<Key) – Filter frequency is modulated by note pitch according to this setting. A value of 100% means that the frequency doubles per octave. The center point for this function is C3.

Filter Envelope Rates<Velocity (Time<Vel) – This parameter exists for filter, pitch, LFO and volume envelopes. It is therefore listed in the [section on envelopes](#).

Filter Frequency<Envelope (Envelope) – Filter frequency is modulated by the filter envelope according to this setting. A value of 100% means that the envelope can create a maximum frequency shift of approximately 9 octaves.

Shaper – This chooser selects the curve for the filter's waveshaper.

Drive – This boosts or attenuates the signal level being sent to the waveshaper.

Dry/Wet – This adjusts the balance between the dry signal and the signal processed by the waveshaper.

LFO Shell and Display

LFO On – This turns the LFO (low-frequency oscillator) on and off. Turning it off when it is unused saves some CPU power.

LFO Waveform – Select from among several typical LFO waveforms. Sample and Hold creates random steps, and Noise supplies bandpass-filtered noise. All waveforms are band-limited to avoid unwanted clicks.

LFO Range – The LFO covers an extreme frequency range. Choose Low for a range from 50 seconds to 30 Hz, or Hi for 8 Hz to 12 kHz. Sync causes the LFO's rate to be synced to your Set's tempo. Due to the possible high frequencies, the LFO can also function as a fifth oscillator.

Retrigger (R) – When enabled, the LFO restarts at the same position in its phase each time a note is triggered. With R disabled, the LFO is free-running.

LFO Rate (Rate) – This sets the rate of the LFO. The actual frequency also depends on the setting of the LFO Range and the LFO Rate<Key controls.

LFO Amount (Mod) – This sets the overall intensity of the LFO. Note that the actual effect also depends on the LFO envelope.

LFO to Osc (Destination A-D) – The LFO modulates the frequency of the respective oscillator if this is turned on.

LFO Amount A – This sets the intensity of the LFO's modulation of the oscillators and filter.

LFO Destination B – This sets the second modulation destination for the LFO.

LFO Amount B – This sets the intensity of the LFO's modulation of the secondary target.

LFO Envelope Rates<Velocity (Time<Vel) – This parameter exists for filter, pitch, LFO and volume envelopes. It is therefore listed in the [section on envelopes](#).

LFO Rate<Key (Rate<Key) – The LFO's frequency can be a function of note pitch. If this is set to 100%, the LFO will double its frequency per octave, functioning like a normal oscillator.

LFO Amount<Velocity (Amt<Vel) – This setting adjusts modulation of the LFO intensity by note velocity.

Oscillators A-D Shell and Display

Osc On – This turns the oscillator on and off.

Osc Coarse Frequency (Coarse) – The relationship between oscillator frequency and note pitch is defined by the Coarse and Fine parameters. Coarse sets the ratio in whole numbers, creating a harmonic relationship.

Osc Fine Frequency (Fine) – The relationship between oscillator frequency and note pitch is defined by the Coarse and Fine parameters. Fine sets the ratio in fractions of whole numbers, creating an inharmonic relationship.

Osc Fixed Frequency On (Fixed) – In Fixed Mode, oscillators do not respond to note pitch but instead play a fixed frequency.

Osc Fixed Frequency (Freq) – This is the frequency of the oscillator in Hertz. This frequency is constant, regardless of note pitch.

Osc Fixed Multiplier (Multi) – This is used to adjust the range of the fixed frequency. Multiply this value with the value of the oscillator's Freq knob to get actual frequency in Hz.

Osc Output Level (Level) – This sets the output level of the oscillator. If this oscillator is modulating another, its level has significant influence on the resulting timbre. Higher levels usually create bright and/or noisy sounds.

Envelope / Oscillator Switches – These switches toggle the display between the oscillator's envelope and its harmonics editor.

16/32/64 – These switches set the number of partials that are available for user editing.

Osc Waveform (Wave) – Choose from a collection of carefully selected waveforms. You can then edit them via the harmonics editor.

Osc Feedback (Feedback) – An oscillator can modulate itself if it is not modulated by another oscillator. The modulation is dependent not only on the setting of the feedback control but also on the oscillator level and the envelope. Higher feedback creates a more complex resulting waveform.

Osc Phase (Phase) – This sets the initial phase of the oscillator. The range represents one whole cycle.

Retrigger (R) – When enabled, the oscillator restarts at the same position in its phase each time a note is triggered. With R disabled, the oscillator is free-running.

Repeat – Higher harmonics can be generated by repeating the drawn partials with a gradual fadeout, based on the settings in the Repeat chooser. Low Repeat values result in a

brighter sound, while higher values result in more high-end roll-off and a more prominent fundamental. With Repeat off, partials above the 16th, 32nd or 64th harmonic are truncated.

Osc Frequency<Velocity (Osc<Vel) – The frequency of an oscillator can be modulated by note velocity. Positive values raise the oscillator's pitch with greater velocities, and negative values lower it.

Osc Freq<Vel Quantized (Q) – This allows quantizing the effect of the Frequency<Velocity parameter. If activated, the sonic result is the same as manually changing the Coarse parameter for each note.

Volume Envelope Rates<Velocity (Time<Vel) – This parameter exists for filter, pitch, LFO and volume envelopes. It is therefore listed in the [section on envelopes](#).

Osc Output Level<Velocity (Vel) – This defines how much the oscillator's level depends upon note velocity. Applying this to modulating oscillators creates velocity-dependent timbres.

Osc Output Level<Key (Key) – This defines how much the oscillator's level depends upon note pitch. The center point for this function is C3.

Envelope Display

Envelope Attack Time (Attack) – This sets the time it takes for a note to reach the peak level, starting from the initial level. For the oscillator envelopes, the shape of this segment of the envelope is linear. For the filter and pitch envelopes, the shape of the segment can be adjusted.

Envelope Decay Time (Decay) – This sets the time it takes for a note to reach the sustain level from the peak level. For the oscillator envelopes, the shape of this segment of the envelope is exponential. For the filter and pitch envelopes, the shape of the segment can be adjusted.

Envelope Release Time (Release) – This is the time it takes for a note to reach the end level after a note-off message is received. For the oscillator envelopes, this level is always -inf dB and the shape of the segment is exponential. For the filter and pitch envelopes, the end level is determined by the End Level parameter and the shape of the segment can be adjusted. This envelope segment will begin at the value of the envelope at the moment the note-off message occurs, regardless of which segment is currently active.

Envelope Initial Level (Initial) – This sets the initial value of the envelope.

Envelope Peak Level (Peak) – This is the peak level at the end of the note attack.

Envelope Sustain Level (Sustain) – This is the sustain level at the end of the note decay. The envelope will stay at this level until note release unless it is in Loop, Sync or Beat Mode.

Envelope End Level (End) – (Filter and pitch envelopes only) This is the level reached at the end of the Release stage.

Envelope Mode (Mode) – If this is set to Loop, the envelope will start again after the end of the decay segment. If set to Beat or Sync, it will start again after a given beat-time. In Sync Mode, this behavior will be quantized to song time. In Trigger mode, the envelope ignores note off.

Envelope Beat/Sync Rate (Repeat) – The envelope will be retriggered after this amount of beat-time, as long as it is still on. When retriggered, the envelope will move at the given attack rate from the current level to the peak level.

Envelope Loop Time (Time) – If a note is still on after the end of the decay/sustain segment, the envelope will start again from its initial value. The time it takes to move from the sustain level to the initial value is defined by this parameter.

Envelope Rates<Velocity (Time<Vel) – Envelope segments will be modulated by note velocity as defined by this setting. This is especially interesting if the envelopes are looping. Note that this modulation does not influence the beat-time in Beat or Sync Modes, but the envelope segments themselves.



The filter and pitch envelopes also provide parameters that adjust the slope of their envelope segments. Positive slope values cause the envelope to move quickly at the beginning, then slower. Negative slope values cause the envelope to remain flat for longer, then move faster at the end. A slope of zero is linear; the envelope will move at the same rate throughout the segment.



Attack Slope (A.Slope) – Adjusts the shape of the Attack envelope segment.

Decay Slope (D.Slope) – Adjusts the shape of the Decay envelope segment.



Release Slope (R.Slope) – Adjusts the shape of the Release envelope segment.



Context Menu Parameters

Certain operations and parameters in Operator are only available via the  (PC) /  (Mac) context menu. These include:

Copy commands for Oscillators – The  (PC) /  (Mac) context menu of the oscillator's shell and envelope display provide options for copying parameters between oscillators.

Envelope commands – The  (PC) /  (Mac) context menu for all envelope displays provide options to quickly set all envelope levels to maximum, minimum, or middle values.

Harmonics editor commands – The  (PC) /  (Mac) context menu for the harmonics editor can restrict partial drawing to even or odd harmonics and toggle normalization of an oscillator's output level. There is also a command to export the waveform as an .ams file.

Play By Key – This command, in the  (PC) /  (Mac) context menu for the filter's Freq control, optimizes the filter for key tracking by setting the cutoff to 466 Hz and setting the Freq<Key to 100%.

23.9 Orchestral Strings, Brass, Woodwinds and Percussion

Orchestral Strings, Brass, Woodwinds and Percussion are high-quality orchestral sample libraries created in collaboration with SONIVOX. These multi-gigabyte collections are carefully multisampled at a variety of velocities and with a number of articulations.

These products are not included with the standard version of Live, but are special features available for purchase separately.

23.9.1 Installation

The orchestral libraries are installed separately from the main Live installation. To install, drag the relevant Live Packs into the Live application window, either from your operating system or from Live's Browser.

After you have installed the libraries of your choice, you will need to authorize them. Further details can be found at the [Ableton website](http://www.ableton.com/authorize)³.

23.9.2 Using the Orchestral Presets

After installation, the orchestral instruments are accessed through Live's Device Browser, in exactly the same way as Live's other built-in instruments. You will find them as categorized presets within the *Instrument Rack* folder. These instruments are therefore loaded just like any other device, by dragging a preset from the Browser into an empty MIDI track.

The presets are available in Full and Lite versions, allowing you to choose the right balance of fidelity and polyphony for your needs. The Lite versions reduce CPU, RAM and disk requirements by reducing the number of zones and sample layers used. Both the Full and Lite presets use 24-bit multisamples. Additionally, you can Hot-Swap between different quality levels of the same preset and any Macro edits you have already made will be preserved after the swap.

There are also LE Packs available for each library which contain very efficient versions of the instruments suitable for sketching out ideas. The LE instruments are all composed of 16-bit sample files.

All of the orchestral presets are conveniently mapped to **Macro Controls** for greater expression.

Each instrument is available in *Solo* and *Section* presets which contain all available articulations. Additionally, each instrument's articulation is available as a separate preset.

In the multi-articulation presets, the various articulations are separated into individual chains in the Rack. You can switch between them in real time via the "Articulation" Macro control.

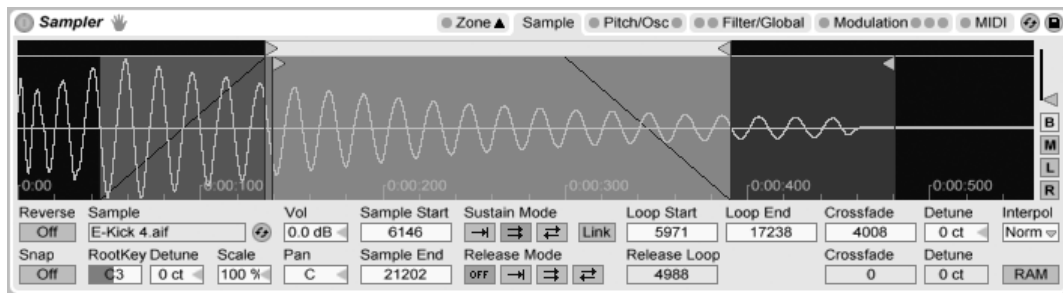

³<http://www.ableton.com/authorize>

23.10 Sampler



The Sampler Instrument.

Sampler is a sleek yet formidable multisampling instrument that takes full advantage of Live's agile audio engine. It has been designed from the start to handle multi-gigabyte instrument libraries with ease, and it imports most common library formats. But with Sampler, playback is only the beginning; its extensive internal modulation system, which addresses nearly every aspect of its sound, makes it the natural extension of Live's sound-shaping techniques.

The full version of Sampler is not included with the standard version of Live, but is a special feature available for purchase separately. Sampler users who want to share their presets with all Live users can convert their work to **Simpler** presets. To do this,  (PC) /  (Mac) on Sampler's title bar and choose the Sampler -> Simpler command.

Getting started with Sampler is as easy as choosing a preset from the Device Browser. Like all of Live's devices, Sampler's presets are located in folders listed beneath its name. Presets imported from third-party sample libraries are listed here, too, in the *Imports* folder.

Once you have loaded a Sampler preset into a track, remember to arm the track for recording (which also enables you to hear any MIDI notes you might want to play), and then start playing!

23.10.1 Multisampling

Before going on, let's introduce the concept of *multisampling*. This technique is used to accurately capture the complexity of instruments that produce dynamic timbral changes. Rather than rely on the simple transposition of a single recorded sample, multisampling

captures an instrument at multiple points within its critical sonic range. This typically means capturing the instrument at different pitches as well as different levels of emphasis (played softly, moderately, loudly, etc.). The resulting *multisample* is a collection of all the individually recorded sample files.

Sampler is designed to let you approach multisampling on whatever level you like: You can load and play multisample presets, like those from Ableton's *Essential Instrument Collection*, import multisamples from third-party vendors, or create your own multisamples from scratch.

Importing Third-Party Multisamples

To import a third-party multisample, navigate to the file in Live's File Browser and double-click to import it into the Live Library. *(Note that AKAI-formatted CD-ROMs require one step before this can be done – please see the next section.)*

Importing will create new Sampler presets, which you can find in the Device Browser under Sampler/Imported. Live automatically brings up the Device Browser to show the new presets, ready to drag in, sort, rename or delete.

Note that some multisample files will be converted to **Instrument Rack** presets that contain several Sampler instances used to emulate the original more accurately.

For all multisample formats except Apple EXS24/GarageBand and Kontakt, Live will import the actual audio data into the Library, where they will appear as new samples (found under Samples/Imported). This means the new Sampler presets will work regardless of whether the original multisample file is still around.

To import Apple EXS24/GarageBand and Kontakt multisamples, Live will create new Sampler presets that reference the original WAV or AIF files. This means that removing the original WAV or AIF files will render the new Sampler presets useless. Live's File Manager offers the option to **collect and save these external samples into the Library**.

Mounting AKAI Multisample CDs

To import multisamples from AKAI-formatted CD-ROMs, you first have to mount the CD-ROM so that Live can "see" its contents. This is only necessary because the legacy AKAI CD format cannot be processed by the operating system like standard CD-ROM formats,

which are mounted automatically upon inserting and can be browsed as usual with Live's File Browser. Here are the steps:

1. Insert the AKAI-formatted sample CD.
2. *On a Mac*, click on the title bar of Live's File Browser and select "All Volumes." *On a PC*, navigate Live's File Browser to the Workspace by clicking on the Browser's title bar and selecting "Workspace."
3. Click on the Browser item found at the bottom named "Find Sample CDs..."
4. Double-click the item that appears to import the CD's contents.

23.10.2 Sampler's Tabs

Once you begin working with Sampler, you will notice that its features are organized categorically into tabs, accessed from Sampler's title bar. In addition to serving as an organizational aid, each tab has LEDs that indicate if there is modulation information in the corresponding area. We will get to know Sampler by examining each of these tabs.

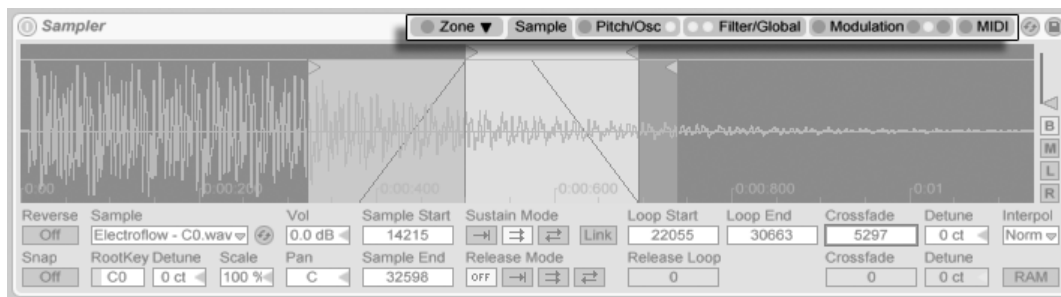

Sampler's Tabs in the Title Bar.

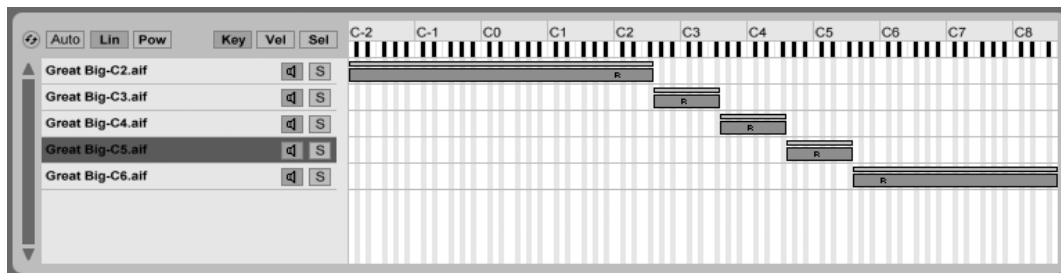

23.10.3 The Zone Tab





The Key Zone Editor.

Clicking on the Zone tab toggles the display of Sampler's Zone Editor, which offers a hands-on interface for mapping any number of samples across three types of ranges.

The Zone Editor opens in its own dedicated view, directly above the Track View. When used in conjunction with Sampler's other tabs, this layout greatly accelerates the creation and editing of multisamples.

On the left side of the Zone Editor is the sample layer list, where multisamples are organized. All of the individual samples belonging to a multisample are shown in this list, where they are referred to as *layers*. For complex multisamples, this list can be quite long. Pressing  (PC) /  (Mac) within the sample layer list opens a context menu that offers a variety of options for sorting and displaying the layers, distributing them across the keyboard and various other sample management and "housekeeping" options.

The rest of the view is occupied by one of three editors that correspond to the sample layers: the Key Zone Editor, the Velocity Zone Editor and the Sample Select Editor. These editors can be horizontally zoomed by pressing  (PC) /  (Mac) within them to bring up a context menu with sizing options.

Auto Select (Auto) – As MIDI notes arrive at Sampler, they are filtered by each sample layer's key, velocity and sample select zones. With Auto Select enabled, all sample layers that are able to play an incoming note will become selected in the sample layer list for the duration of that note.

Zone Fade Mode (Lin/Pow) – These buttons toggle the fade mode of all zones between linear and constant-power (exponential) slopes.

Zone Editor View (Key/Vel/Sel) – These buttons toggle the display of the Key Zone, Velocity Zone and Sample Select Editors.

The Sample Layer List

All samples contained in the currently loaded multisample are listed here, with each sample given its own layer. For very large multisamples, this list might be hundreds of layers long! Fortunately, layers can be descriptively named (according to their root key, for example). Mousing over a layer in the list or a zone in the zone editors will display relevant information about the corresponding sample in the Status Bar. Selecting any layer will load its sample into the *Sample* tab for examination.

Key Zones

Key zones define the range of MIDI notes over which each sample will play. Samples are only triggered when incoming MIDI notes lie within their key zone. Every sample has its own key zone, which can span anywhere from a single key up to the full 127.

A typical multisampled instrument contains many individual samples, distributed into many key zones. Samples are captured at a particular key of an instrument's voice range (known as their *root key*), but may continue to sound accurate when transposed a few semitones up or down. This range usually corresponds to the sample's key zone; ranges beyond this zone are represented by additional samples, as needed.

By default, the key zones of newly imported samples cover the full MIDI note range. Zones can be moved and resized like clips in the Arrangement View, by dragging their right or left edges to resize them, then dragging them into position.

Zones can also be faded over a number of semitones at either end by dragging their top right or left corners. This makes it easy to smoothly crossfade between adjacent samples as the length of the keyboard is traversed. The Lin and Pow boxes above the sample layer list indicate whether the zones will fade in a linear or exponential manner.

Velocity Zones

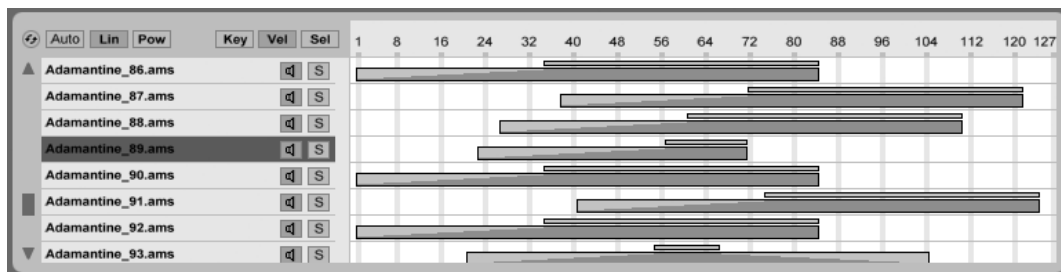

The Velocity Zone Editor.

Velocity zones determine the range of MIDI Note On velocities that each sample will respond to. The timbre of most musical instruments changes greatly with playing intensity. Therefore, the best multisamples capture not only individual notes, but also each of those notes at different velocities.

The Velocity Zone Editor, when toggled, appears alongside the sample layer list. Velocity is measured on a scale of 1-127, and this number range appears across the top of the editor. The functionality of the Velocity Zone Editor is otherwise identical to that of the Key Zone Editor.

Sample Select Zones

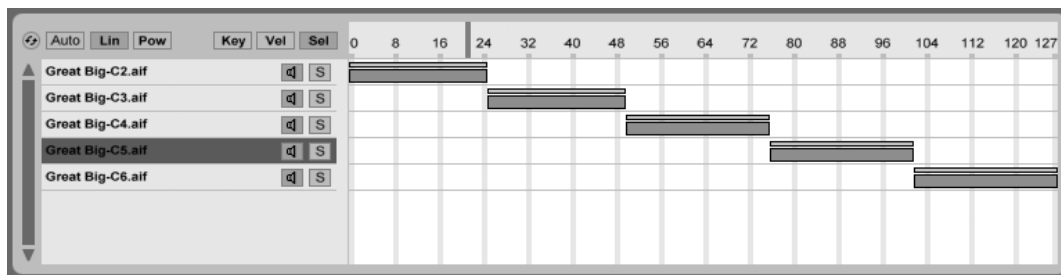

The Sample Select Editor.

Each sample also has a Sample Select zone, which is a data filter that is not tied to any particular kind of MIDI input. Sample Select zones are very similar to the [Chain Select Zones](#)

found in **Racks**, in that only samples with sample select values that overlap the current value of the *sample selector* will be triggered.

The Sample Select Editor, when toggled, appears alongside the sample layer list. The editor has a scale of 0-127, similar to the Velocity Zone Editor. Above the value scale is the draggable indicator known as the sample selector.

Please note that the position of the sample selector only determines which samples are available for triggering. Once a sample has been triggered, changing the position of the sample selector will not switch to a different sample during playback.

23.10.4 The Sample Tab

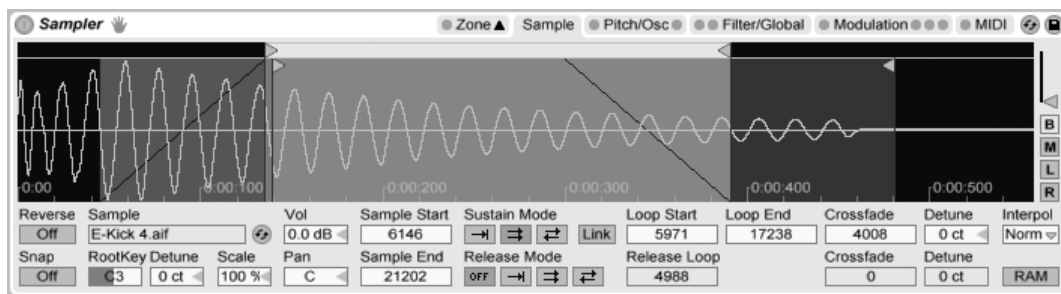

The Sample Tab.

The playback characteristics of individual samples are set within the Sample tab. Most of this tab is dedicated to displaying the waveform of the currently selected sample. Mousing over the waveform will display relevant information about the sample in the Status Bar. It is important to keep in mind that most of the values in this tab reflect the state of the currently selected sample only. The Sample chooser always displays the current sample layer's name, and is another way to switch between layers when editing.

The RootKey, Detune, Vol and Pan parameters add basic per-sample mixing tools for quick assembly and tweaking of multisamples.

Reverse – This is a global, modulatable control that reverses playback of the entire multi-sample. Unlike the Reverse function in the Clip View, a new sample file is not generated. Instead, sample playback begins from the Sample End point, proceeds backwards through the Sustain Loop (if active), and arrives at the Sample Start point.

Snap – Snaps all start and end points to the waveform zero-crossings (points where the amplitude is zero) to avoid clicks. As with *Simpler*, this snap is based on the left channel of stereo samples, so a small *Crossfade* value may be necessary in some cases to completely eliminate clicks.

Sample – Displays the name of the current sample layer, and can be used to quickly select from among the sample layers of the loaded multisample.

Root Key (RootKey) – Defines the root key of the current sample.



Detune – The sample tuning can be adjusted here by +/- 50 cents.

Volume – A wide-range volume control, variable from full attenuation to a gain of +24 dB.

Pan – Samples can be individually panned anywhere in the stereo panorama.

Sample Playback

All of the following *sample-specific* parameters work in conjunction with the *global* volume envelope (in the Filter/Global tab) to create the basic voicing of the Sampler instrument. If you are unfamiliar with how envelopes work, you will find that they are well documented in Operator's [Envelopes section](#).

All time-based values in this tab are displayed in either samples or hours:seconds:milliseconds, which can be toggled using the  (PC) /  (Mac) context menu on any of their parameter boxes. *Samples in this context refer to the smallest measurable unit in digital audio, and not to the audio files themselves, which we more commonly refer to as "samples."*

Sample Start – The time value where playback will begin. If the volume envelope's *Attack* parameter is set to a high value, the audible result may seem to begin some time later than the value shown here.

Sample End – The time value where playback will end (unless a loop is enabled), even if the volume envelope has not ended.

Sustain Mode – The optional *Sustain Loop* defines a region of the sample where playback will be repeated while the note is in the sustain stage of its envelope. Activating the *Sustain Loop* also allows the *Release Loop* to be enabled. This creates several playback options:

 *No Sustain Loop* – Playback proceeds linearly until either the Sample End is reached or the volume envelope completes its release stage.

 *Sustain Loop Enabled* – Playback proceeds linearly until Loop End is reached, when it jumps immediately to Loop Start and continues looping. If Release Mode is OFF, looping will continue inside the Sustain Loop until the volume envelope has completed its release stage.

 *Back-and-Forth Sustain Loop Enabled* – Playback proceeds to Loop End, then reverses until it reaches Loop Start, then proceeds again towards Loop End. If Release Mode is OFF, this pattern continues until the volume envelope has completed its release stage.

Link – Enabling the Link switch sets Sample Start equal to Loop Start. Note that the Sample Start parameter box doesn't lose its original value – it simply becomes disabled so that it can be recalled with a single click.



Release Mode – Whenever the Sustain Loop is active, Release Mode can also be enabled.

 *OFF* – The volume envelope's release stage is active, but will occur within the Sustain Loop, with playback never proceeding beyond Loop End.

 *Release Enabled* – When the volume envelope reaches its release stage, playback will proceed linearly towards Sample End.

 *Release Loop Enabled* – When the volume envelope reaches its release stage, playback will proceed linearly until reaching Sample End, when it jumps immediately to Release Loop and continues looping until the volume envelope has completed its release stage.

 *Back-and-Forth Release Loop Enabled* – When the volume envelope reaches its release stage, playback will proceed linearly until reaching Sample End, then reverses until it reaches Release Loop, then proceeds again towards Sample End. This pattern continues until the volume envelope has completed its release stage.

Sustain- and Release-Loop Crossfade (Crossfade) – Loop crossfades help remove clicks from loop transitions. By default, Sampler uses constant-power fades at loop boundaries. But by turning off "Use Constant Power Fade for Loops" in the  (PC) /  (Mac) context menu, you can enable linear crossfades.

Sustain- and Release-Loop Detune (Detune) – Since loops are nothing more than oscillations,

the pitch of samples may shift within a loop, relative to the loop's duration. With Detune, the pitch of these regions can be matched to the rest of the sample.

Interpolation (Interpol) – This is a global setting that determines the accuracy of transposed samples. Be aware that raising the quality level above “Normal” will place significant demands on your CPU.

RAM Mode (RAM) – This is also a global control that loads the entire multisample into RAM. This mode can give better performance when modulating start and end points, but loading large multisamples into RAM will quickly leave your computer short of RAM for other tasks. In any case, it is always recommended to have as much RAM in your computer as possible, as this can provide significant performance gains.

23.10.5 The Pitch/Osc Tab

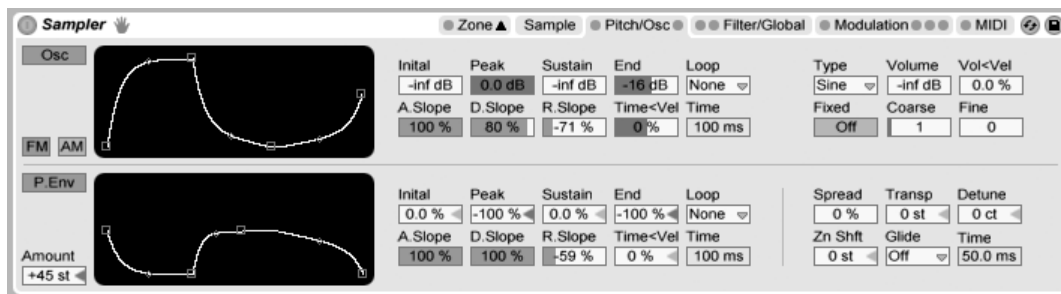

The Pitch/Osc Tab.

The Modulation Oscillator

Sampler features one dedicated modulation oscillator per voice, which can perform frequency or amplitude modulation (*FM* or *AM*) on the multisample. The oscillator is fully featured, with 21 waveforms, plus its own loopable amplitude envelope for dynamic wave-shaping. Note that this oscillator performs modulation only – its output is never heard directly. What you hear is the *effect* of its output upon the multisample.

The Pitch Envelope

The pitch envelope modulates the pitch of the sample over time, as well as of the Modulation Oscillator, if it is enabled. This is a multi-stage envelope with Initial, Peak, Sustain and End levels. The time needed to travel between the levels is determined by the Attack, Decay and Release settings. The values of the envelope parameters can be adjusted via the sliders, or by dragging the breakpoints in the envelope's display. Clicking on the diamonds between the breakpoints allows you to adjust the slope of the envelope segments. Positive slope values cause the envelope to move quickly at the beginning, then slower. Negative slope values cause the envelope to remain flat for longer, then move faster at the end. A slope of zero is linear; the envelope will move at the same rate throughout the segment.

23.10.6 The Filter/Global Tab

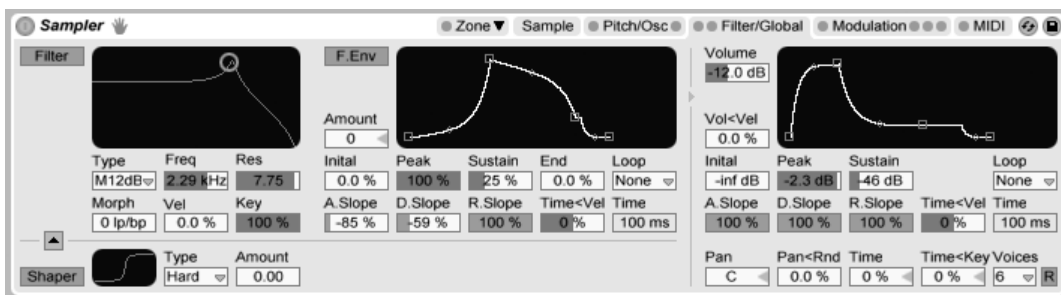

The Filter/Global Tab.

The Filter

Sampler features a polyphonic filter with an optional integrated waveshaper. The *Morph* filter types can morph continuously from lowpass to bandpass to highpass to notch and back to lowpass. Naturally, filter morphs can be [automated](#).

Classic 24 dB lowpass, bandpass and highpass modes supplement the morphable filter's 12 dB and 24 dB modes.

The filter's cutoff frequency can be modulated over time by a dedicated filter envelope, which works similarly to the envelope in the Pitch/Osc tab.

Four different curves can be chosen for the waveshaper, and its overall intensity can be controlled with the Amount slider. In addition, the signal flow direction can be adjusted with the button above the waveshaper area. With the triangle pointing up, the signal passes from the shaper to the filter. With the triangle pointing down, it passes from the filter to the shaper.

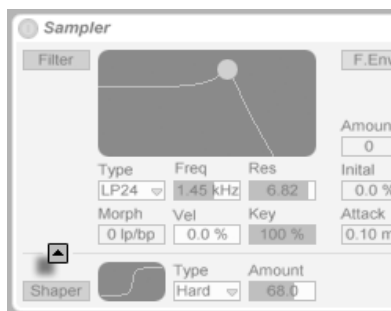

The Filter/Shaper Order Button.

The Volume Envelope

The volume envelope is global, and defines the articulation of Sampler's voices. Up to 32 voices are available simultaneously from each instance of the device. Voice retriggering can optionally be enabled by activating the Retrigger button to the right of the Voices chooser.

23.10.7 The Modulation Tab

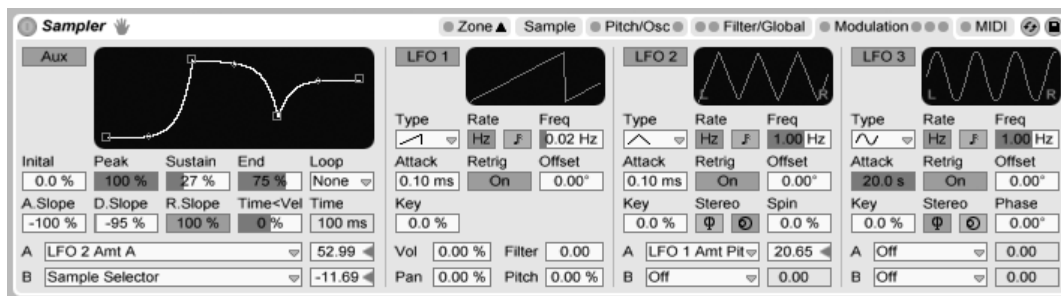

The Modulation Tab.

The Modulation tab offers an additional loopable envelope, plus three LFOs, all capable of modulating multiple parameters, including themselves. Each LFO can be free running, or synced to the Live Set's tempo, and LFOs 2 and 3 can produce stereo modulation effects.

LFO Attack (Attack) – This is the time needed for the LFO to reach maximum intensity. Use this, for example, to gradually introduce vibrato as a note is held.

LFO Retrigger (Retrig) – Enabling Retrigger for an LFO will cause it to reset to its starting point, or initial phase, on each new MIDI note. This can create hybrid LFO shapes if the LFO is retriggered before completing a cycle.

LFO Offset (Offset) – This changes the starting point, or initial phase of an LFO, so that it begins at a different point in its cycle. This can create hybrid LFO shapes if the LFO is retriggered before completing a cycle.

LFO Rate < Key (Key) – Also known as *keyboard tracking*, non-zero values cause an LFO's rate to increase relative to the pitch of incoming MIDI notes.

LFO Stereo Mode (Stereo) – LFOs 2 and 3 can produce two types of stereo modulation: *Phase* or *Spin*. In phase mode, the right and left LFO channels run at equal speed, and the *Phase* parameter is used to offset the right channel from the left. In spin mode, the *Spin* parameter can make the right LFO channel run up to 50% faster than the left.

23.10.8 The MIDI Tab



The MIDI Tab.

The MIDI tab's parameters turn Sampler into a dynamic performance instrument. The MIDI controllers *Key*, *Velocity*, *Release Velocity*, *Aftertouch*, *Modulation Wheel*, *Foot Controller* and *Pitch Bend* can be mapped to two destinations each, with varying degrees of influence.

23.11 Session Drums

Session Drums is a multisampled library of acoustic drumkits recorded by Chocolate Audio. The collection consists of both *stereo* and *multimic* presets, programmed as [Drum Racks](#) for easy editing and performance possibilities.

The stereo presets are “production-ready” kits, carefully processed to reflect modern production techniques while keeping CPU and memory usage to a minimum. These kits come in both Full (24-bit) and LE (16-bit) versions.

The multimic presets provide maximum flexibility. Each instrument is recorded with multiple microphones and with minimal processing. The individual drum chains contains samples of both the original instrument (either from a close or internal mic, depending on the drum) and its “bleed” into a variety of additional open microphones. Each of these levels can be mixed independently.

For maximum realism, each drum chain contains carefully programmed MIDI effects that switch between related samples automatically as notes are retriggered. This eliminates the “machine gun” effect common to sampled drum libraries.

The full version of Session Drums is not included with the standard version of Live, but is a special feature available for purchase separately.

23.11.1 Session Drums Installation

Session Drums is installed separately from the main Live installation. To install, drag the Session Drums Live Packs into the Live application window, either from your operating system or from Live’s Browser.

After you have installed Session Drums, you will need to authorize it. Further details can be found at the [Ableton website](#)⁴.

⁴<http://www.ableton.com/authorize>

23.11.2 Accessing the Session Drums Presets

After installation, the Session Drums presets are accessed through Live's Device Browser, in exactly the same way as Live's other built-in instruments. You will find them as categorized presets within the *Drum Rack* folder. Session Drums presets are therefore loaded just like any other device, by dragging a preset from the Browser into an empty MIDI track.

The presets are arranged into Stereo and Multimic folders in the Browser. Complete kits and individual drums are listed in separate folders in each section.

23.11.3 Mixing the Drums

Because the Session Drums presets are organized as Drum Racks, the individual instruments can be **mixed alongside tracks** in the Session mixer. Additionally, the multimic presets include three *return chains*, which also appear in the mixer and can be mixed independently:

- *Snare Bottom* – this chain controls the level of the ambient vibration of the snares for each instrument
- *Overhead* – controls the level of the stereo overhead mics
- *Room* – controls the level of the stereo room mics

For both the stereo and multimic kits, each drum's close or internal mic is shown as a channel in the Session View mixer.

23.11.4 Modifying the Drumkits

All of the Session Drums presets are conveniently mapped to **Macro Controls** for greater expression. The specific mappings differ between the stereo and multimic presets, although all presets include the following two:

- *Hihat Pedal* – this Macro adjusts the openness of the hihat. This is primarily a control for use by keyboard players; if you have an electronic drumkit with a hihat pedal that sends CC4 data, this will control hihat openness automatically.

- *Velocity Sensitivity* – this Macro adjusts the dynamic range of the drumkit. As you turn up this control, the kit will play louder at high velocity and softer at low velocities.

In the stereo presets, the additional Macros control tuning and decay times for the individual drums in the kit. In the multimic presets, they control the ambience and room characteristics of the return chains in the Drum Rack.

From the Drum Rack's **Pad View**, you can easily replace individual instruments within the kit. For example, to replace a snare drum with one from another kit, use the Browser to navigate to the folder of the desired kit's snare presets. Then drag the entire folder to the Drum Rack's pad view. This will replace all of the currently loaded snare components, leaving all other pads alone. Because Ableton's drum collections share common note mappings, this works when swapping between any instruments in the Session Drums or **Drum Machines** libraries.

You can also easily replace single instrument components via Live's hot-swap functionality. To exchange only a single tom, for example, click on its pad's Hot-Swap button. Live will automatically list all matching presets in the Browser, allowing you to choose another tom. Of course, if you would like to replace the tom with another kind of instrument, you can simply navigate to another folder and make your selection there.

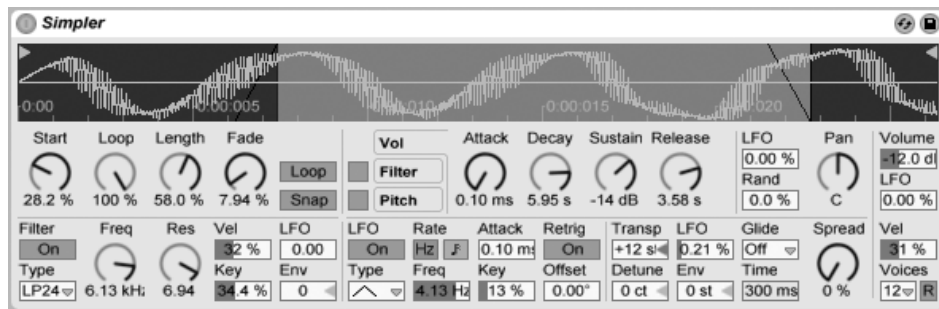

Session Drums also includes a comprehensive collection of **Live Clips**, which are installed to your Library. Loading a Live Clip to an empty MIDI track loads a combination of MIDI notes, a drum kit and custom effects that you can use as a starting point for your own creative work.

23.12 Simpler



The Simpler Instrument.

Simpler is an instrument that integrates the basic elements of a sampler with a set of classic synthesizer parameters. A Simpler voice plays a user-defined sample section, which is in turn processed by envelope, filter, LFO, volume and pitch components.

Presets created in Simpler can be converted for use in [Sampler](#), and vice-versa. To do this,  (PC) /  (Mac) on Simpler's title bar and choose the Simpler -> Sampler command. In this way, presets created in Simpler can be further edited with Sampler's extended functionality.

23.12.1 Sample View

The Sample View displays the sample waveform. Samples can be dragged into Simpler either directly from the Browser, or from the Session or Arrangement View in the form of clips. In the latter case, Simpler will utilize only the section of the sample demarcated by the clip's start/end or loop markers. Samples can be replaced by dragging in a new sample, or by activating the integrated [Hot-Swap button](#).

Note: When playing instruments from Ableton's [Essential Instrument Collection](#), Simpler runs in *Multisample Mode*. The Sample View has no function in this mode.

23.12.2 Sample Controls



Simpler plays a specific region or loop of the sample, as determined by a group of sample controls.

The Start and Length controls work together to specify where Simpler begins and ends its sweep of the sample. As the name implies, Start defines where sample playback starts. The sample will play for the length defined by the Length parameter. Both parameters are defined as a percentage of the whole region, so setting start to 25 percent and length to 50 percent, for example, will start playback 1/4 of the way through the sample and stop playback at the 3/4 mark (using 50 percent of the sample).

Samples are played by Simpler as one-shots or as loops, depending on whether or not the Loop switch is active. When looping is active, the Loop control dictates the length of the loop, starting from the end of the playing sample. Simpler will play the first instance of a looped sample beginning with the Start point, then continue playing only the loop region.

When the sample's start or end points are moved, Simpler will try to preserve the loop length for as long as possible by automatically adjusting the Start, Loop and Length settings.

It is possible for glitches or pops to occur between a looped sample's start and end points due to the discontinuity in waveform amplitude (i.e., the sample's loudness). The Snap switch will help mitigate these by forcing Simpler's loop markers to snap to *zero-crossing* points in the sample (points where the amplitude is zero). Note: Snapping is based on the left channel of stereo samples. It is therefore still possible, even with Snap activated, to encounter glitches with stereo samples.

The transition from loop end to loop start can be smoothed with the Fade control, which crossfades the two points. This method is especially useful when working with long, textural samples. By default, Simpler uses constant-power fades. But by turning off "Use Constant Power Fade for Loops" in the  (PC) /  (Mac) context menu, you can enable linear crossfades.

23.12.3 Zoom

Quite often, one starts with a longer region of a sample and ends up using only a small part of it. Simpler's Sample view can be zoomed and panned just as in other parts of Live – drag

vertically to zoom, and drag horizontally to pan different areas of the sample into view.

23.12.4 Envelope

Simpler contains three classic ADSR envelopes, as seen in most synthesizers, for shaping the dynamic response of the sample. Volume-, filter frequency-, and pitch modulation are all modifiable by toggling their respective buttons in the envelope section. *Attack* controls the time in milliseconds that it takes for the envelope to reach its peak value after a note is played. *Decay* controls the amount of time it takes for the envelope to drop down to the *Sustain* level, which is held until the note is released. *Release* time is the amount of time after the end of the note that it takes for the envelope to drop from the Sustain level back down to zero.

The influence of envelopes on pitch and filter cutoff can be decided using the envelope amount (Env) controls in each of these sections.

23.12.5 Filter

The Filter section offers classic 12 dB or 24 dB lowpass, bandpass and highpass filters, as well as a notch filter, each of which can impart different sonic characteristics onto the sample by removing certain frequencies from the waveform. The most important parameters are the typical synth controls Frequency and Resonance. *Frequency* determines where in the harmonic spectrum the filter is applied; *Resonance* boosts frequencies near that point.

The best way to understand the effects of these controls is simply to play with them!

The Frequency parameter can be modulated by an LFO, note velocity and an envelope – each of which have an amount control in the Filter section. The Key (tracking) control allows for shifting the filter's frequency according to note pitch.

23.12.6 LFO

The LFO (low-frequency oscillator) section offers sine, square, triangle, sawtooth down, sawtooth up and random waveforms. The LFO run freely at frequencies between 0.01 and

30 Hz, or sync to divisions of the Set's tempo. LFOs are applied individually to each voice, or played note, in Simplr.

The Key parameter scales each LFO's Rate in proportion to the pitch of incoming notes. A high Key setting assigns higher notes a higher LFO rate. If Key is set to zero, all voices' LFOs have the same rate and may just differ in their phase.

The LFO will modulate the filter, pitch, panorama and volume according to the setting of the LFO amount controls in each of these sections.

The time required for the LFO to reach full intensity is determined by the Attack control.

23.12.7 Glide and Spread

Simplr includes a glide function. When this function is activated, new notes will start from the pitch of the last note played and then slide gradually to their own pitch. Two glide modes are available: Glide, which works monophonically, and Portamento, which works polyphonically. Glide is also adjusted with the Glide Time control.

Simplr also offers a special Spread parameter that creates a rich stereo chorus by using two voices per note and panning one to the left and one to the right. The two voices are detuned, and the amount of detuning can be adjusted with the Spread control.

Tip: Whether or not spread is applied to a particular note depends upon the setting of the Spread parameter during the note-on event. To achieve special effects, you could, for instance, create a sequence where Spread is zero most of the time and turned on only for some notes. These notes will then play in stereo, while the others will play mono.

23.12.8 Pitch, Pan, Volume and Voices

Simplr plays back a sample at its original pitch if the incoming MIDI note is C3, however the Transpose control allows transposing this by +/- 48 semitones. Pitch can also be modulated by an LFO or pitch envelope using the amount controls in this section. The pitch envelope is especially helpful in creating percussive sounds. Simplr reacts to MIDI Pitch Bend messages with a sensitivity of +/- 5 semitones. You can also modulate the Transpose parameter with clip envelopes and external controllers.

The Voices parameter sets the maximum number of voices that Simplr can play simultaneously. If more voices are needed than have been allocated by the Voices chooser, “voice stealing” will take place, in which the oldest voice(s) will be dropped in favor of those that are new. For example, if your Voices parameter is set to 8, and ten voices are all vying to be played, the two oldest voices will be dropped. (Simplr does try to make voice stealing as subtle as possible.) A small LED near the Voices control flashes when a voice has been stolen.

Panorama is defined by the Pan control, but can be further swayed by randomness or modulated by the LFO.

Finally, the output volume of Simplr is controlled by the Volume control, which can also be dependent upon note velocity, as adjusted by the Velocity control. Tremolo effects can be achieved by allowing the LFO to modulate the Volume parameter.

23.12.9 Strategies for Saving CPU Power

Real-time synthesis needs lots of computing power. However, there are strategies for reducing CPU load. Save the CPU spent on Simplr by doing some of the following:

- Turn off the Filter if it is not needed.
- Use filter types that are less expensive when possible. A filter’s cost correlates with the steepness of its slope – “LP24” is more expensive than “LP12.”
- Turn off the LFO for a slightly positive influence on CPU.
- Stereo samples need significantly more CPU than mono samples, as they require twice the processing.
- Decrease the number of simultaneously allowed voices with the Voice control.

23.13 Tension

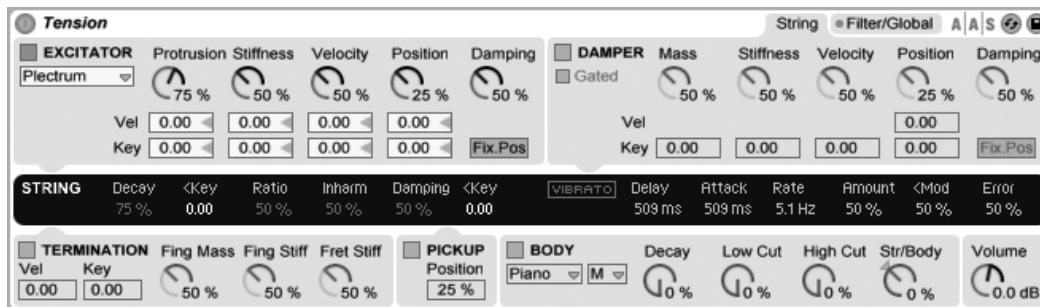

The Tension Instrument.

Tension is a synthesizer dedicated to the emulation of string instruments, and developed in collaboration with Applied Acoustics Systems. The synthesizer is entirely based on physical modeling technology and uses no sampling or wavetables. Instead, it produces sound by solving mathematical equations that model the different components in string instruments and how they interact. This elaborate synthesis engine responds dynamically to the control signals it receives while you play thereby reproducing the richness and responsiveness of real string instruments.

The full version of Tension is not included with the standard version of Live, but is a special feature available for purchase separately.

Tension features four types of excitators (two types of hammer, a pick and a bow) an accurate model of a string, a model of the fret/finger interaction, a damper model and different types of soundboards. The combination of these different elements allows for the reproduction of a wide range of string instruments. Tension is also equipped with filters, LFOs and envelope parameters that extend the sound sculpting possibilities beyond what would be possible with “real-world” instruments. Finally, Tension offers a wide range of performance features, including keyboard modes, portamento, vibrato and legato functions.

23.13.1 Architecture and Interface

It is the vibration from the *string* which constitutes the main sound production mechanism of the instrument. The string is set into motion by the action of an *excitator* which can be

a hammer, a pick or a bow. The frequency of the oscillation is determined by the effective length of the string, which is controlled by the finger/fret interaction or *termination*. A *dampener* can be applied to the strings in order to reduce the decay time of the oscillation. This is the case on a piano, for example, when felt is applied to the strings by releasing the keys and sustain pedal. The vibration from the string is then transmitted to the *body* of the instrument, which can radiate sound efficiently. In some instruments, the string vibration is transmitted directly to the body through the bridge. In other instruments, such as the electric guitar, a *pickup* is used to transmit the string vibration to an amplifier. In addition to these main sections, a *filter* section has been included between the string and body sections in order to expand the sonic possibilities of the instrument.

The Tension interface is divided into two main tabs, which are further divided into sections. The *String* tab contains all of the fundamental sound producing components related to the string itself: *Excitator*, *String*, *Dampener*, *Termination*, *Pickup* and *Body*. The *Filter/Global* tab contains the *Filter* section, as well as controls for global performance parameters. Each section (with the exception of String and the global Keyboard section) can be enabled or disabled independently. Turning off a section reduces CPU usage.

23.13.2 String Tab

The String tab contains the parameters related to the physical properties of the string itself, as well as the way in which it's played.

The Excitator Section



Tension's Excitator Section.

The modelled string can be played using different types of excitators in order to reproduce different types of instruments and playing techniques. The excitator is selected using the Type chooser, and the choices available are *Bow*, *Hammer*, *Hammer (bouncing)* and *Plectrum*.

Bow - this excitator is associated with bowed instruments such as the violin, viola or cello. The bow sets the string in sustained oscillation. The motion of the bow hair across the string creates friction, causing the string to alternate between sticking to the hair and breaking free. The frequency of this alternation between sticking and slipping determines the fundamental pitch.

The Force knob adjusts the amount of pressure being applied to the string by the bow. The sound becomes more "scratchy" as you increase this value. The friction between the bow and the string can be adjusted with the Friction control. Higher values usually result in a faster attack. Velocity adjusts the speed of the bow across the string. Finally, the Vel and Key sliders below these three controls allow you to modulate their behavior based on note velocity or pitch, respectively.

Hammer and *Hammer (bouncing)* - these two excitator types simulate the behavior of soft hammers or mallets. Hammer models a hammer that is located below the string and strikes it once before falling away. This type of mechanism is found in a piano, for example. Hammer (bouncing) models a hammer that is located above the string and is dropped onto it, meaning that it can bounce on the string multiple times. This playing mode can be found on a hammered dulcimer, for example.

The mass and stiffness of the hammer are adjusted with the (surprise) Mass and Stiffness knobs, while Velocity controls the speed at which the hammer is struck against the string. As with the Bow excitator, these three parameters can be further modulated by note velocity and pitch by adjusting the Vel and Key sliders. The behavior of the hammer is further controlled by the Damping knob, which adjusts how much of the hammer's impact force is absorbed back into the hammer. It is somewhat analogous to the Stiffness parameter, but instead of controlling the stiffness of the hammer's surface it adjusts the stiffness of the virtual "spring" that connects the hammer to the mass that powers it. As you increase the Damping amount, the interaction between the hammer and string will become shorter, generally resulting in a louder, brighter sound.

Plectrum - a plectrum or "pick" is associated with instruments such as guitars and harpsichords. It can be thought of as an angled object placed under the string that snaps the

string into motion.

The Prot knob (for “protrusion”) adjusts how much of the plectrum’s surface area is placed under the string. Lower values results in a “thinner,” smaller sound, as there is less mass setting the string into motion. The Stiffness, Velocity and Damping knobs behave similarly to the Hammer mode. And as with the previous modes, all three of these parameters can be modulated by velocity or note pitch via the Vel and Key sliders.

The Position knob is applicable to each excicator model, and specifies the point on the string where the excicator makes contact. At 0%, the excicator contacts the string at its termination point, while at 50% it activates the string at its midpoint. The behavior is a bit different if the Fix. Pos switch is enabled, however. In this case, the contact point is fixed to a single location, rather than changing as the length of the string changes. This behavior is similar to that of a guitar, where the picking position is always basically the same regardless of the notes being played. On a piano, the excicator position is relative - the hammers normally strike the string at about 1/7th of their length - and so is best modelled with Fix. Pos turned off. The excicator’s position can additionally be modulated by velocity or note pitch, via the Vel and Key sliders.

The Excicator section can be toggled on or off via the switch next to its name. With it off, the string can only be activated by interaction with its **damper**. (If both the Excicator and Damper sections are disabled, nothing can set the string in motion - if you find that you’re not producing any sound, check to see that at least one of these sections is on.)

Please note that the Excicator section’s parameters work closely together to influence the overall behavior of the instrument. You may find that certain combinations of settings result in no sound at all, for example.

The String Section

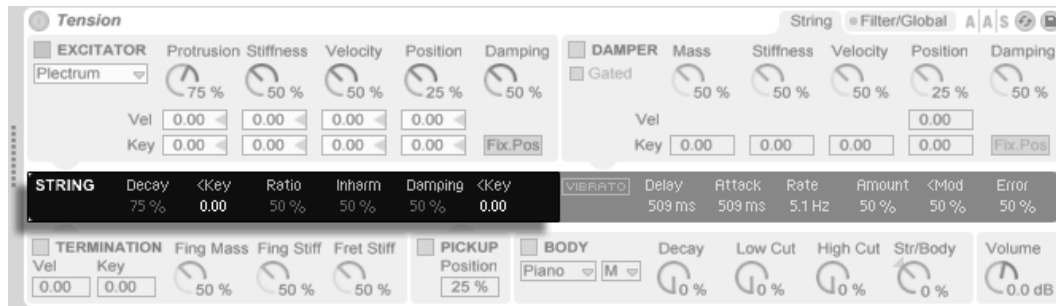

Tension's String Section.

The vibration of the string is the main component of a stringed instrument's sound. The effective length of the string is also responsible for the pitch of the sound we hear.

The theoretical model of a resonating string is harmonic, meaning that the string's partials are all exact multiples of the fundamental frequency. Real-world strings, however, are all more or less inharmonic, and this increases with the width of the string. The Inharm slider models this behavior, causing upper partials to become increasingly out of tune as its value increases.

The Damping slider adjusts the amount of high frequency content in the string's vibration. Higher values result in more upper partials (less damping). This parameter can be modulated by note pitch via the <Key slider to its right.

The Decay slider determines how long it takes for the resonating string to decay to silence. Higher values increase the decay time. The <Key slider next to Decay allows decay time to be modulated by note pitch.

The Ratio knob sets the ratio of the decay time of the string's oscillation during note onset and release. When Ratio is turned all the way to the left, the time set by the Decay knob sets the decay time for both the onset and release of the note. As you turn Ratio up, the release time decreases but the onset decay time stays the same.

The Vibrato Section



Tension's Vibrato Section.

The Vibrato section uses an LFO to modulate the string's pitch. As with all of Tension's parameters, the controls in this section can be used to enhance the realism of a stringed instrument model – or to create something never heard before.

The two most important parameters in this section are the Rate and Amount sliders. Rate adjusts the frequency of the pitch variation, while Amount adjusts the intensity (amplitude) of the effect.

The Delay slider sets how long it will take for the vibrato to start after the note begins, while Attack sets how long it takes for the vibrato to reach full intensity (as set by the Amount knob).

The <Mod slider adjusts how much the modulation wheel will affect the vibrato intensity. This control is relative to the value set by the Amount knob.

The Error slider introduces unpredictability into the vibrato, by introducing random deviation to the Rate, Amount, Delay and Attack parameters.

The Damper Section



Tension's Damper Section.

All string instruments employ some type of damping mechanism that mutes the resonating string. In pianos, this is a felt pad that is applied to the string when the key is released. In instruments such as guitars and violins, the player damps by stopping the string's vibration with the fingers. Dampers regulate the decay of strings but also produce some sound of their own, which is an important characteristic of a string instrument's timbre.

Although a damper functions to mute the string rather than activate it, it is somewhat analogous to a hammer, and shares some of the same parameters.

The Mass knob controls how hard the damper's surface will press against the string. As you increase the value, the string will mute more quickly.

The stiffness of the damper's material is adjusted with the Stiffness control. Lower values simulate soft materials such as felt, while higher values model a metal damper.

Note that very high Mass and Stiffness values can simulate dampers that connect with the string hard enough to change its effective length, thus causing a change in tuning.

The Velocity control adjusts the speed with which the damper is applied to the string when the key is released, as well as the speed with which it is lifted from the string when the key is depressed. Be careful with this parameter - very high Velocity values can cause the damper to hit the string extremely hard, which can result in a very loud sound on key release. Note that the state of the Gated switch determines whether or not the Velocity control is enabled. When the Gated switch is turned on, the damper is applied to the string when the key is released. With Gated off, the damper always remains on the string, which means that the Velocity control has no effect.

The Mass, Stiffness and Velocity parameters can be further modulated by note pitch, via the sliders below.

The stiffness of the damper mechanism is adjusted with the Damping knob, which affects the overall amount of vibration absorbed by the damper. Lower values result in less damping (longer decay times.) But this becomes a bit less predictable as the Damping value goes over 50%. At higher values, the mechanism becomes so stiff that it bounces against the string. This in turn reduces the overall amount of time that the damper is in contact with the string, causing an increase in decay time. The best way to get a sense of how this parameter behaves is to gradually turn up the knob as you repeatedly strike a single key.

The Position knob serves an analogous function to the control in the Excitator section, but here specifies the point on the string where the damper makes contact. At 0%, the damper contacts the string at its termination point, while at 50% it damps the string at its midpoint. The behavior is a bit different if the Fix. Pos switch is enabled, however. In this case, the contact point is fixed to a single location, rather than changing as the length of the string changes. The damper's position can additionally be modulated by velocity or note pitch, via the Vel and Key sliders.

The Damper section can be toggled on or off via the switch next to its name.

The Termination Section



Tension's Termination Section.

The Termination section models the interaction between the fret, finger and string. On a physical instrument, this interaction is used to change the effective length of the string, which in turn sets the pitch of the note played. The physical parameters of the finger are

adjusted with the Fing Mass and Fing Stiff knobs, which set the force the finger applies to the string and the finger's stiffness, respectively. The Mass amount can be additionally modulated by velocity or note pitch via the sliders. The stiffness of the fret is modelled with the Fret Stiff parameter.

The Pickup Section



Tension's Pickup Section.

The Pickup section models an electromagnetic pickup, similar to the type found in an electric guitar or electric piano. The only control here is the Position slider, which functions similarly to this parameter in the Excitator and Damper sections. At 0%, the pickup is located at the string's termination point, while at 50% it is under the midpoint of the string. Lower values generally result in a brighter, thinner sound, while higher values have more fullness and depth.

The Pickup section can be toggled on or off via the switch next to its name.

The Body Section

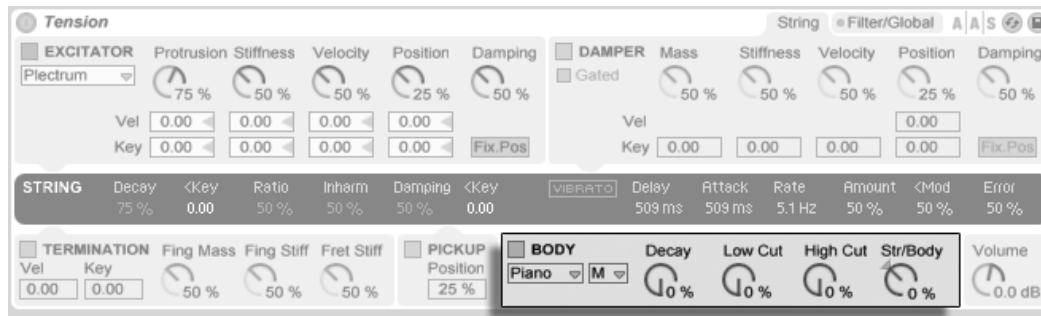

Tension's Body Section.

The role of the body or soundboard of a string instrument is to radiate the vibration energy from the strings. The body also filters these vibrations, based on its size and shape. In some instruments, such as guitars, the body also includes an air cavity which boosts low frequencies.

The body type chooser allows you to select from different body types modelled after physical instruments.

You can set the size of the body from the small chooser, from extra small to extra large. In general, as you increase the body size, the frequency of the resonance will become lower. You can further modify the body's frequency response with the Hi Cut and Low Cut knobs.

The decay time of the body's resonance can be adjusted with the Decay knob. Higher values mean a longer decay.

The Str/Body knob adjusts the ratio between the String section's direct output and the signal filtered by the Body section. When turned all the way to the right, there is no direct output from the String section. When turned all the way to the left, the Body section is effectively bypassed.

The Body section can be toggled on or off via the switch next to its name.

The lonely Volume knob to the right of this section sets the overall output of the instrument. This knob is replicated on the Filter/Global tab.

23.13.3 Filter/Global Tab

The Filter/Global tab contains the filter parameters for the instrument, as well as global controls.

The Filter Section

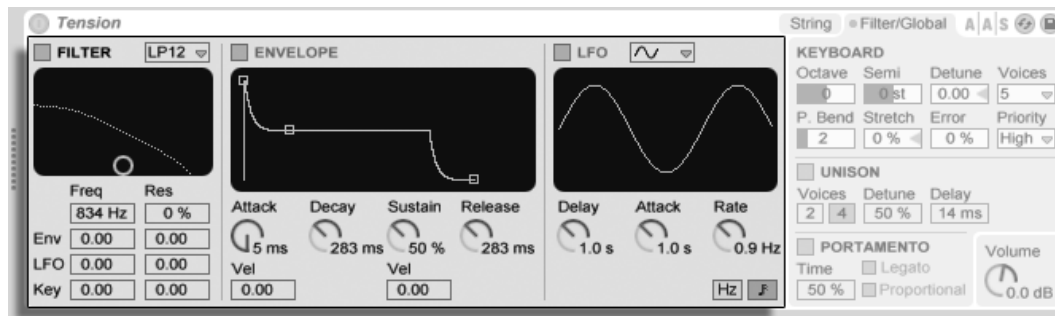

Tension's Filter Section.

Tension's Filter section features a highly configurable multi-mode filter that sits between the String and Body sections. In addition, the filter can be modulated by a dedicated envelope generator and low-frequency oscillator (LFO).

The filter's chooser allows you to select the filter type. You can choose between 2nd and 4th order low-pass, band-pass, notch, high-pass and formant filters.

The resonance frequency of the filter is adjusted with the Freq slider, while the amount of resonance is adjusted with the Res control. When a formant filter is chosen in the chooser, the Res control cycles between vowel sounds. The Freq and Res controls can each be modulated by LFO, envelope or note pitch via the sliders below. Note that the LFO and Env sliders have no effect unless the Envelope and LFO subsections are enabled.

The Envelope generator is a standard ADSR (attack, decay, sustain, release). This section can be toggled on or off via the switch next to its name.

The attack time is set with the Attack knob. This time can also be modulated by velocity via the Vel slider below the knob. As you increase the Vel value, the attack time will become increasingly shorter at higher velocities.

The time it takes for the envelope to reach the sustain level after the attack phase is set by the Decay knob.

The Sustain knob sets the level at which the envelope will remain from the end of the decay phase to the release of the key. When this knob is turned all the way to the left, there is no sustain phase. With it turned all the way to the right, there is no decay phase. The sustain level can be additionally modulated by velocity via the Vel slider below the knob. Higher values result in an increased sustain level as the velocity increases.

Finally, the release time is set with the Release knob. This is the time it takes for the envelope to reach zero after the key is released.

The LFO subsection provides an additional modulation source for the filter. This section can be toggled on or off via the switch next to its name.

The waveform chooser sets the type of waveform used by the LFO. You can choose between sine, triangle, rectangular and two types of random waveforms. The first random waveform steps between random values while the second uses smoother ramps.

The Delay knob sets how long it will take for the LFO to start after the note begins, while Attack sets how long it takes for the oscillator to reach its full amplitude.

The LFO's speed is set with the Rate knob. The switches below this knob toggle the Rate between frequency in Hertz and tempo-synced beat divisions.

The entire Filter section can be toggled on or off via the switch next to its name.

Global and Keyboard Parameters



Tension's Global and Keyboard Parameters.

The remaining section contain all of the parameters that adjust how Tension responds to MIDI data, as well as controls for performance parameters such as tuning and portamento.

The Keyboard section contains all of Tension's polyphony and tuning parameters. The Voices chooser sets the available polyphony, while Priority determines which notes will be cut off when the maximum polyphony is exceeded. When Priority is set to High, new notes that are higher than currently sustained notes will have priority, and notes will be cut off starting from the lowest pitch. Low Priority is the opposite. A setting of Last gives priority to the most recently played notes, cutting off the oldest notes as necessary.

The Octave, Semi and Tuning controls function as coarse and fine tuners. Octave transposes the entire instrument by octaves, while Semi transposes up or down in semitone increments. The Tuning slider adjusts in increments of one cent (up to a maximum of 50 cents up or down).

The pitch bend modulation range in semitones is set by the P. Bend slider.

Stretch simulates a technique known as stretch tuning, which is a common tuning modification made to electric and acoustic pianos. At 0%, Tension will play in equal temperament, which means that two notes are an octave apart when the upper note's fundamental pitch is exactly twice the lower note's. But because the actual resonance behavior of a vibrating tine or string differs from the theoretical model, equal temperament tends to sound "wrong" on pianos. Increasing the Stretch amount raises the pitch of upper notes while lowering the pitch of lower ones. The result is a more brilliant sound. Negative values simulate "negative" stretch tuning; upper notes become flatter while lower notes become sharper.

The Error slider increases the amount of random tuning error applied to each note. Try very high values if you would like to relive your experiences from junior high school orchestra.

The Unison section allows you to stack multiple voices for each note played. The switch next to the name toggles the section on or off.

The Voices switch selects between two or four stacked voices, while Detune adjusts the amount of tuning variation applied to each stacked voice. Low values can create a subtle chorusing effect, while high values provide another good way to approximate a youth orchestra. Increasing the Delay amount adds lag before each stacked voice is activated.

The Portamento section is used to make the pitch slide between notes rather than changing immediately. The effect can be toggled on and off via the switch next to its name.

With Legato enabled, the sliding will only occur if the second note is played before the first note is released.

Proportional causes the slide time to be proportional to the interval between the notes. Large intervals will slide slower than small intervals. Disabling this switch causes the slide time to be constant regardless of interval.

The Time slider sets the overall speed of the slide.

The Volume knob sets the overall output of the instrument.

23.13.4 Sound Design Tips

At first glance, Tension's modular architecture may not seem so different from what you're used to in other synthesizers; it consists of functional building blocks that feed information through a signal path and modify it as it goes. But it's important to remember that Tension's components are not isolated from one another; what you do to one parameter can have a dramatic effect on a parameter somewhere else. Because of this, it's very easy to find parameter combinations that produce no sound at all. It's also very easy to create *extremely* loud sounds, so be careful when setting levels!

When programming Tension, it may help to think about the various sections as if they really are attached to a single, physical object. For example, a bow moving at a slow speed could perhaps excite an undamped string. But if that string is constricted by an enormous damper, the bow will need to increase its velocity to have any effect.

To get a sense of what's possible, it may help to study how the presets were made. You'll soon realize that Tension can do far more than just strings.

23.14 The Essential Instrument Collection

The boxed version of Live 8 ships with the Essential Instrument Collection, a multi-giga-byte library of meticulously sampled instruments created in cooperation with SONiVOX, Chocolate Audio and Puremagnetik.

Note – The Essential Instrument Collection is not included with downloadable purchases. Download customers can choose, however, to have the Live 8 box including the Essential Instrument Collection [shipped to them later for an additional fee](#)⁵.

23.14.1 EIC Installation

The Essential Instrument Collection is installed separately from the main Live installation. The various instruments on the EIC DVD are grouped into separate Live Packs that can be installed as needed. To install Live Packs, drag them into the Live application window, either from your operating system or from Live's Browser.

After you have installed the EIC Live Packs, you will need to authorize them. Further details can be found at the [Ableton website](#)⁶.

23.14.2 Accessing The EIC Instruments

After installation, the EIC instruments are accessed through Live's Device Browser, in exactly the same way as Live's other built-in instruments. You will find them as categorized presets within the *Instrument Rack* folder. EIC instruments are therefore loaded just like any other device, by dragging a preset from the Browser into an empty MIDI track.

⁵<http://www.ableton.com/shop>

⁶<http://www.ableton.com/authorize>

The EIC presets are available in Full and Lite versions, allowing you to choose the right balance of fidelity and polyphony for your needs. The Lite version reduces CPU, RAM and disk requirements by reducing the number of zones and sample layers used. Both the normal and Lite presets use 24-bit multisamples.

There is also an EIC LE Pack available which contains very efficient versions of the EIC instruments suitable for sketching out ideas. The LE instruments are all composed of 16-bit sample files.

All of the EIC presets are conveniently mapped to **Macro Controls** for greater expression.

23.14.3 The Included Instruments

The following multisampled instruments are included:

- **Acoustic Keyboards** – *Grand Piano, Harpsichord, Celesta*
- **Electric Keyboards** – *E-Piano MK 1, B3 Jazz Organ, B3 Rock Organ*
- **Orchestral Strings** – *Solo Strings (legato): Double Bass, Cello, Viola, Violin; Ensemble Strings (legato, pizzicato)*
- **Orchestral Brass** – *Solo Brass (legato): French Horn, Bass Trombone, Tuba (Eb), Trumpet; Ensemble Brass (legato, staccato)*
- **Orchestral Woodwinds** – *Solo Woodwinds (legato, legato vibrato): English Horn, Bassoon, Clarinet, French Oboe, Concert Flute, Alto Sax; Ensemble Woodwinds (legato)*
- **Plucked Instruments** – *Harp (fingers), Jazz Upright Bass, P-Bass (fingers, picks), Six-String Nylon Guitar (tones, chords), Strat Clean (tones, chords)*
- **Mallets** – *Glockenspiel (hard mallets), Xylophone (hard mallets)*
- **Voice** – *Mixed Choir (ahh, ohh)*
- **Drum Machine** – *one drum machine, selected from the **Drum Machines** add-on product*
- **Acoustic Drum Kit** – *one stereo multisampled drum kit, selected from the **Session Drums** add-on product*

Special Features of the Guitar and Bass Banks

The EIC's guitar instruments have additional banks for single-key chords with strumming, and the PBass instrument has a similar bank for down- and up- strokes played with a pick. In all cases, lower octaves play down strums, while upper octaves play up strums.

Chapter 24

Max For Live

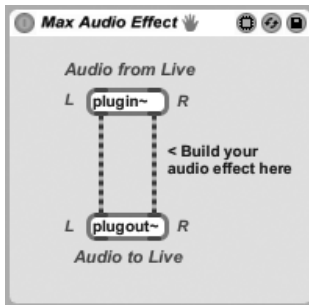

A Generic Max Audio Effect.

Max for Live, an add-on product co-developed with [Cycling '74](http://www.cycling74.com)¹, allows users to extend and customize Live by creating instruments, controllers, audio effects, and MIDI processors.

After installing Max for Live, you will need to point to it in Live's File/Folder Preferences:

¹<http://www.cycling74.com>

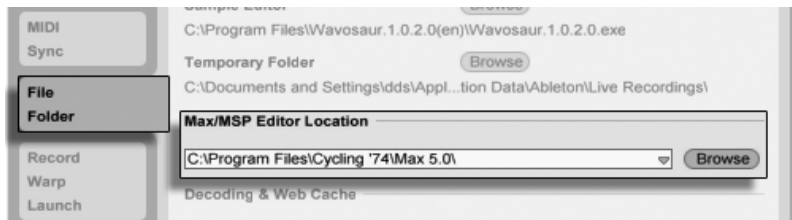

The Max Editor Chooser.

Like all other Live devices, Max devices can have their own presets, which can be viewed and loaded by unfolding the device in the Browser.

What a Max device actually does is dependent on its *patch*, which can be accessed by pressing the Edit button in the Max device's title bar.



The Edit Button for a Max Device.

This launches the Max for Live application, with the current device loaded and ready for editing.

After editing, you can save your Max patch and it will automatically update any devices that use the patch in your current Live Set. Like samples, Max patches can be saved in your Library or within Project folders. They can also be organized using Live's [File Manager](#), which can help ensure that your files and dependencies stay self-contained.

To learn more about building and editing Max devices, see the documentation that came with Max for Live.

Chapter 25

Sharing Live Sets

Live provides tools to collaborate with other Live users by uploading and downloading Live Sets from Ableton's web server. Any media files which are needed by your Live Sets are uploaded automatically, unless they are already on Ableton's server. Likewise, any media files which are needed by Sets that you download are only downloaded if you do not already have them. This file management happens automatically.

25.1 Uploading Sets

The File Menu's Share Live Set command saves the current Set to your web space at ableton.com. After selecting this command, you will be asked to enter a name for your Live Set.



Enter the Set's Name in the Upload Details Window.

If you are not already logged in to your ableton.com account, you will then be prompted to enter your username and password.



Log In to Upload Your Set.

After you have logged in, Live will begin uploading your Set, along with any referenced media files that are not already on Ableton's server. Depending on the size of your Set and media, the upload can take some time. The process happens in the background, allowing you to continue working normally with Live. If you quit the program while an upload is in progress, you will be asked if you would like to resume it the next time you run Live.

25.1.1 Non-Portable Tracks

If your Set contains any devices which are not available to every Live user (e.g., any third-party plug-ins or Ableton's add-on instruments such as [Operator](#)), you will be given a chance to [Freeze](#) the affected tracks before uploading. You will also have the option to Freeze any

tracks that contain an [External Instrument](#) or [External Audio Effect](#).

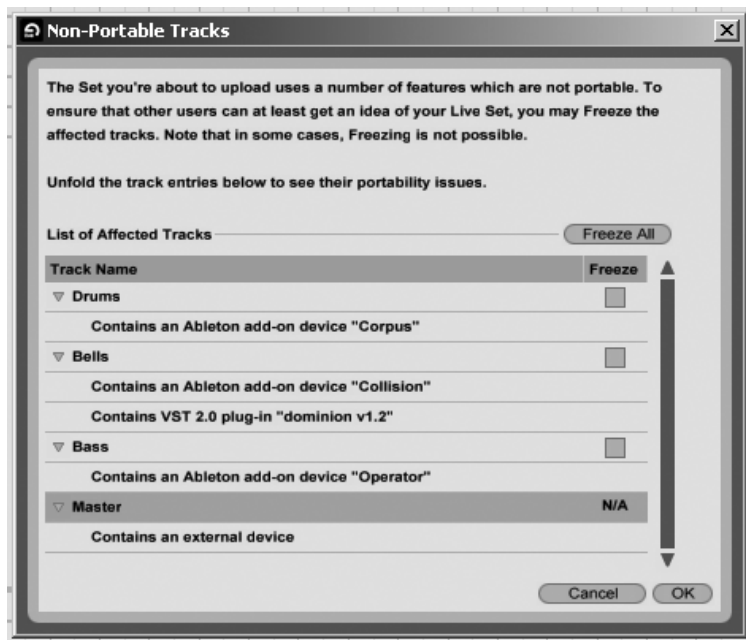

The Non-Portable Tracks Dialog.

Note that Freezing is not always possible; [Group Tracks](#), [return tracks](#) and the [Master track](#), for example, cannot be frozen.

25.2 Downloading Sets

You can download Live Sets that other users have uploaded to [ableton.com](http://www.ableton.com). You can get more information and find Sets [at the Ableton website](http://www.ableton.com/share)¹.

¹<http://www.ableton.com/share>

25.3 The Upload/Download Browser

All files that you download from Ableton's server are stored locally on your machine, in your **cache**. You can view any finished downloads or in-progress transfers via the Upload/Download Browser, which can be accessed via its selector. Note that this selector is not visible until your cache actually contains something.

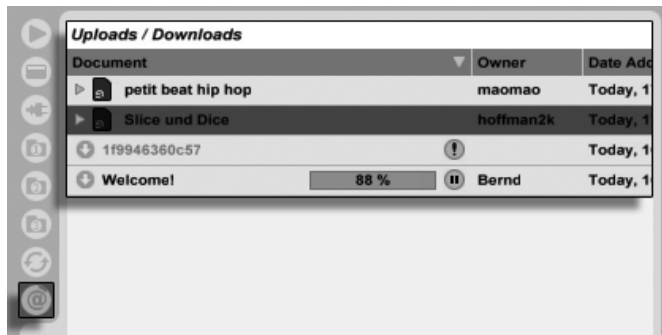

The Upload/Download Browser.

You can load Sets via the Upload/Download Browser once they are finished downloading. Sets that are in the process of transferring will display a progress bar, as well as icons to pause or resume the transfer. Please note that the Upload/Download Browser shows the contents of your cache, which is a read-only folder.

Note: Because downloaded media files are stored in your cache, it is possible for this folder to become very large. Live automatically deletes older files from the cache to make room for those that are new, so you should *not* use the cache for permanent storage. Once you have opened a Set from the Upload/Download Browser, you should save it to your hard drive in a new location. This will create a self-contained copy of the Set, as well as all referenced media files.

Chapter 26

MIDI and Key Remote Control

To liberate the musician from the mouse, most of Live's controls can be *remote-controlled* with an external MIDI controller and the computer keyboard. This chapter describes the details of mapping to the following specific types of controls in Live's user interface:



1. *Session View slots* – Note that MIDI and computer key assignments are bound to the slots, not to the clips they contain.
2. *Switches and buttons* – among them the Track and Device Activator switches, the Control Bar's tap tempo, metronome and transport controls.
3. *Radio buttons* – A radio button selects from among a number of options. One instance of a radio button is the [crossfader assignment section](#) in each track, which offers three options: The track is assigned to the crossfader's A position, the track is unaffected by the crossfader, or the track is affected by the crossfader's B position.
4. *Continuous controls* – like the mixer's volume, pan and sends.
5. *The crossfader*, the behavior of which is described in detail in the [respective section](#) of the Mixing chapter.

26.1 MIDI Remote Control

Live can be controlled remotely by external MIDI control surfaces, such as MIDI keyboards or controller boxes. Live also supports the Akai APC40, a topic that is covered [in its own chapter](#), for completely mouse-free program operation.

Before we explain how remote control assignments are made and implemented, let's first make the distinction between MIDI remote control and a separate use of MIDI in Live: as the input for our MIDI tracks. Let's suppose that you are using a MIDI keyboard to [play an instrument](#) in one of Live's MIDI tracks. If you assign C-1 on your MIDI keyboard to a Session View Clip Launch button, that key will cease play C-1 of your MIDI track's instrument, as it now "belongs" solely to the Clip Launch button.

MIDI keys that become part of remote control assignments can no longer be used as input for MIDI tracks. This is a common cause of confusion that can be easily resolved by observing the Control Bar's [MIDI indicators](#).

Before making any MIDI assignments, you will need to set up Live to recognize your control surfaces. This is done in the MIDI/Sync tab of Live's Preferences, which can be opened with the keyboard shortcut  (PC) /  (Mac).

26.1.1 Natively Supported Control Surfaces

Control Surfaces are defined in the table at the top of the MIDI/Sync tab. Up to six supported control surfaces can be used simultaneously in Live.

	Control Surface	Input	Output	
1	RemoteSL	RemoteSL (Port 1)	RemoteSL (Port 1)	Dump
2	Oxygen8v2	Oxygen8 (Port 1)	Oxygen8 (Port 1)	Dump
3	Tranzport	RemoteSL (Port 2)	RemoteSL (Port 2)	Dump
4	None	None	None	Dump
5	None	None	None	Dump
6	None	None	None	Dump

Setting Up Control Surfaces.

Open the first chooser in the *Control Surface* column to see whether your control surface is supported natively by Live; if it is listed here, you can select it by name, and then define its MIDI input and output ports using the two columns to the right. *If your controller is not*

listed here, don't fret – it can still be enabled manually in the next section, [Manual Control Surface Support](#).

Depending on the controller, Live may need to perform a “preset dump” to complete the setup. If this is the case, the *Dump* button to the right of your control surface's choosers in the Live Preferences will become enabled. Before pressing it, verify that your control surface is ready to receive preset dumps. The method for enabling this varies for each manufacturer and product, so consult your hardware's documentation if you are unsure. Finally, press the Dump button; Live will then set up your hardware automatically.

Instant Mappings

In most cases, Live uses a standard method for mapping its functions and parameters to physical controls. This varies, of course, depending upon the configuration of knobs, sliders and buttons on the control surface. These feature-dependent configurations are known as *instant mappings*.

Within Live's built-in lessons, you will find a *Control Surface Reference* that lists all currently supported hardware, complete with the details of their instant mappings. The Lessons View can be accessed at any time by selecting the Lessons option from the View menu.

Note: You can always *manually override* any instant mappings with your own assignments. In this case, you will also want to enable the Remote switches for the MIDI ports that your control surface is using. This is done in the MIDI Ports section of the MIDI/Sync Preferences tab, and is described in the [next section](#).

Instant mappings are advantageous because the control surface's controllers will automatically reassign themselves in order to control the currently selected device in Live.

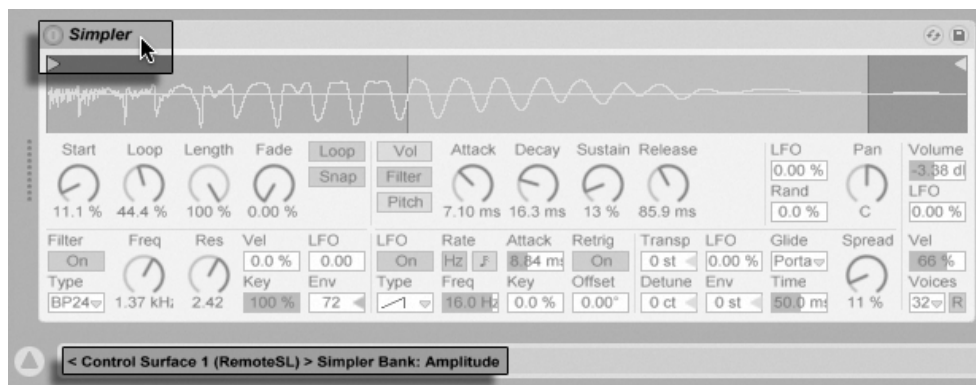

Control Surfaces Can Follow Device Selection.

In addition to following device selection, *natively supported* control surfaces can be “locked” to specific devices, guaranteeing hands-on access no matter where the current focus is in your Live Set. To enable or disable locking, (PC) / (Mac) on a device’s title bar, and then select your preferred controller from the “Lock to...” context menu. You’ll recognize the same list of control surfaces that you defined in the MIDI/ Sync Preferences. By default, the instrument in a MIDI track will automatically be locked to the control surface when the track is armed for recording.

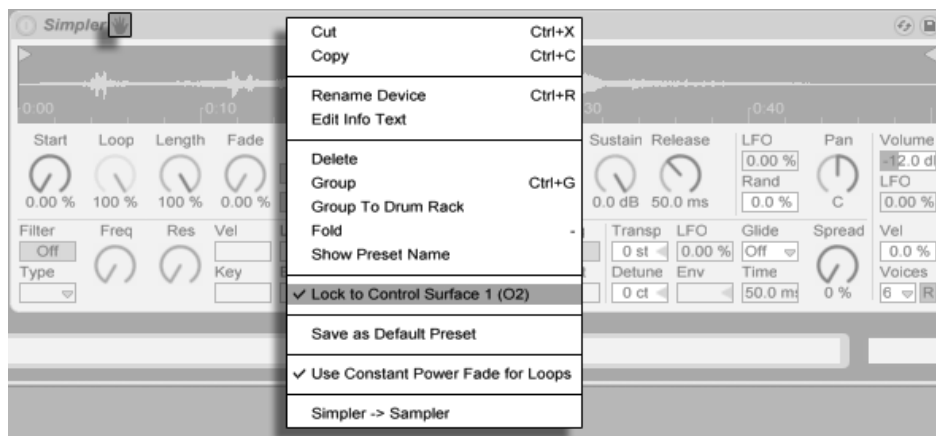

Getting Hands-On: Control Surfaces Can Be Locked to Devices.

A hand icon in the title bar of locked devices serves as a handy reminder of their status.

Note: Some control surfaces do not support locking to devices. This capability is indicated for individual controllers in the *Control Surface Reference* lesson. Select the Lessons option from the View menu to access Live's built-in lessons.

26.1.2 Manual Control Surface Setup

If your MIDI control surface is not listed in the MIDI/Sync Preferences' Control Surface chooser, it can still be enabled for manual mapping in the *MIDI Ports* section of this tab.

MIDI Ports		Track	Sync	Remote
▷ Input:	Oxygen8 (Port 1)	<input type="checkbox"/> On	<input type="checkbox"/> Off	<input type="checkbox"/> Off
▷ Input:	RemoteSL (Port 1)	<input type="checkbox"/> On	<input type="checkbox"/> Off	<input type="checkbox"/> Off
▷ Input:	RemoteSL (Port 2)	<input type="checkbox"/> Off	<input type="checkbox"/> Off	<input checked="" type="checkbox"/> On
▷ Output:	Oxygen8 (Port 1)	<input type="checkbox"/> Off	<input type="checkbox"/> Off	<input type="checkbox"/> Off
▷ Output:	RemoteSL (Port 1)	<input type="checkbox"/> Off	<input type="checkbox"/> Off	<input type="checkbox"/> Off
▷ Output:	RemoteSL (Port 2)	<input type="checkbox"/> Off	<input type="checkbox"/> Off	<input checked="" type="checkbox"/> On
▷ Output:	RemoteSL (Port 3)	<input type="checkbox"/> Off	<input type="checkbox"/> Off	<input type="checkbox"/> Off

Defining Control Surfaces Manually.

The MIDI Ports table lists all available MIDI input and output ports. To use an input port for remote control of Live, make sure the corresponding switch in its *Remote* column is set to "On." You can use any number of MIDI ports for remote mapping; Live will merge their incoming MIDI signals.

When working with a control surface that provides physical or visual feedback, you will also need to enable the Remote switch for its output port. Live needs to be able to communicate with such control surfaces when a value has changed so that they can update the positions of their motorized faders or the status of their LEDs to match.

To test your setup, try sending some MIDI data to Live from your control surface. The Control Bar's **MIDI indicators** will flash whenever Live recognizes an incoming MIDI message.

Once your controller is recognized by Live, you have completed the setup phase (but we recommend that you take the time to select a **Takeover Mode** before you leave the Preferences behind). Your next step will be **creating MIDI mappings** between your control surface and Live. Luckily, this is a simple task, and you only need to do it for one parameter at a time.

26.1.3 Takeover Mode



*MIDI Controller
Takeover Mode.*

When MIDI controls that send absolute values (such as faders) are used in a bank-switching setup, where they address a different destination parameter with each controller bank, you will need to decide how Live should handle the sudden jumps in values that will occur when moving a control for the first time after switching the bank. Three takeover modes are available:

None – As soon as the physical control is moved, its new value is sent immediately to its destination parameter, usually resulting in abrupt value changes.

Pick-Up – Moving the physical control has no effect until it reaches the value of its destination parameter. As soon as they are equal, the destination value tracks the control's value 1:1. This option can provide smooth value changes, but it can be difficult to estimate exactly where the pick-up will take place.

Value Scaling – This option ensures smooth value transitions. It compares the physical control's value to the destination parameter's value and calculates a smooth convergence of the two as the control is moved. As soon as they are equal, the destination value tracks the control's value 1:1.

26.2 The Mapping Browser

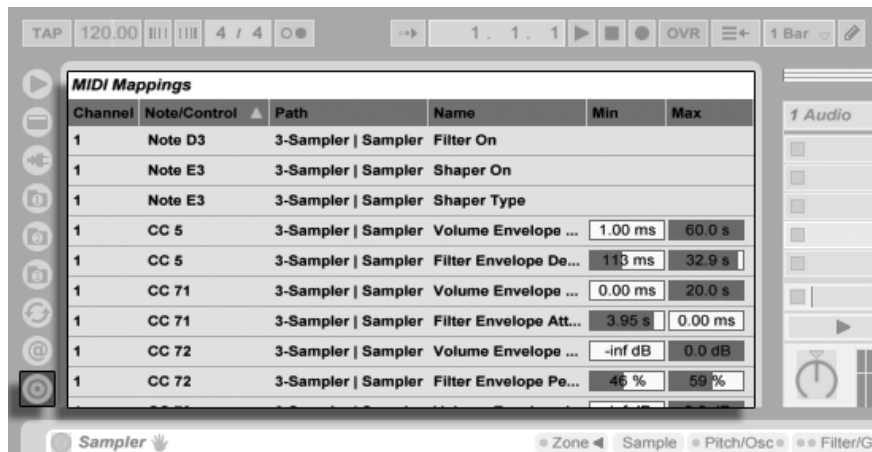

The Mapping Browser and Selector.

All manual MIDI, **computer keyboard** and **Macro Control** mappings are managed by the *Mapping Browser*. The Mapping Browser is hidden until one of the three mapping modes is enabled. It will then display all mappings for the current mode. For each mapping, it lists the control element, the path to the mapped parameter, the parameter's name, and the mapping's *Min* and *Max* value ranges. The assigned *Min* and *Max* ranges can be edited at any time, and can be quickly inverted with a (PC) / (Mac) context menu command. Delete mappings using your computer's or key.

Note that **Instant Mappings** are context based and are not displayed in the Mapping Browser. Their mapping structure can be displayed while working in Live by choosing the Lessons option from the View menu and then opening the *Control Surface Reference* lesson.

26.2.1 Assigning MIDI Remote Control

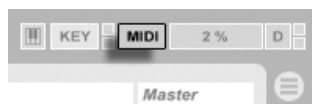

The MIDI Map Mode Switch.

Once your remote control setup has been defined in the MIDI/Sync Preferences, giving MIDI controllers and notes remote control assignments is simple:

1. Enter MIDI Map Mode by pressing the MIDI switch in Live's upper right-hand corner. Notice that assignable elements of the interface become highlighted in blue, and that the Mapping Browser becomes available. *If your Browser is closed, **Ctrl** **Alt** **B** (PC) / **⌘** **Alt** **B** (Mac) will open it for you.*
2. Click on the Live parameter that you'd like to control via MIDI.
3. Send a MIDI message by pressing a keyboard key, turning a knob, etc., on your MIDI controller. You will see that this new MIDI mapping is now listed in the Mapping Browser.
4. Exit MIDI Map Mode by pressing the MIDI switch once again. The Mapping Browser will disappear, but you can always review your mappings by entering MIDI Map Mode again.

26.2.2 Mapping to MIDI Notes

MIDI notes send simple Note On and Note Off messages to Live's interface elements. These messages can produce the following effects on controls in Live:

- *Session View Slots* – Note On and Note Off messages affect clips in the slot according to their [Launch Mode settings](#).
- *Switches* – A Note On message toggles the switch's state.
- *Radio Buttons* – Note On messages toggle through the available options.
- *Variable Parameters* – When assigned to a single note, Note On messages toggle the parameter between its Min and Max values. When assigned to a range of notes, each note is assigned a discrete value, equally spaced over the parameter's range of values.

Hint: Session View slots can be assigned to a MIDI note range for chromatic playing: First play the *root* key (this is the key that will play the clip at its default transposition), and then, *while holding down the root key*, hold one key below the root and one above it to define the limits of the range.

26.2.3 Mapping to Absolute MIDI Controllers

Absolute MIDI controllers send messages to Live in the form of absolute values ranging from 0 to 127. These values lead to different results depending on the type of Live control to which they are assigned. A value message of 127, for example, might turn the Volume control on a Live track all the way up or play a Session View clip. Specifically, MIDI controller messages from 0 to 127 can produce the following effects on controls in Live:

- *Session View Slots* – Controller values 64 and above are treated like Note On messages. Controller values 63 and below are treated like Note Off messages.
- *Switches* – For track activators and on/off buttons in devices, controller values that are within the mapping's Min and Max range turn the switch on. Controller values that are above or below this range turn it off. You can reverse this behavior by setting a Min value that is *higher* than its corresponding Max value. In this case, controller values that are outside of the range turn the switch on, while values inside the range turn it off. For all other switches (such as transport controls), controller values 64 and above turn the switch on, while controller values below 64 turn it off.
- *Radio Buttons* – The controller's 0...127 value range is mapped onto the range of available options.
- *Continuous Controls* – The controller's 0...127 value range is mapped onto the parameter's range of values.

Live also supports pitch bend messages and high-precision ("14-bit Absolute") controller messages with a 0...16383 value range. The above specifications apply to these as well, except that the value range's center is at 8191/8192.

26.2.4 Mapping to Relative MIDI Controllers

Some MIDI controllers can send "value increment" and "value decrement" messages instead of absolute values. These controls prevent parameter jumps when the state of a control in Live and the corresponding control on the hardware MIDI controller differ. For example, imagine that you have assigned the pan knob on your control surface to the pan parameter of a track in Live. If the hardware control is panned hard right, and the Live control is panned hard left, a slight movement in a hardware pan knob that sends absolute values would tell

Live to pan right, causing an abrupt jump in the track's panning. A pan knob sending relative messages would prevent this, since its incremental message to Live would simply say, "Pan slightly to the left of your current position."

There are four types of relative controllers: Signed Bit, Signed Bit 2, Bin Offset and Twos Complement.

Convention (Mode)	Increment	Decrement
Relative (Signed Bit)	001–064	065–127
Relative (Signed Bit 2)	065–127	001–064
Relative (Bin Offset)	065–127	063–001
Relative (2's Comp.)	001–064	127–065

Each of these are also available in a "linear" mode; Some MIDI encoders use "acceleration" internally, generating larger changes in value when they are turned quickly. For control surfaces that are not natively supported, Live tries to detect the controller type and whether acceleration is being used or not.

You can improve the detection process by moving the relative controller slowly to the left when you make an assignment. Live will offer its suggestion in the Status Bar's "mode" chooser, but if you happen to know the relative controller type, you can manually select it.

Live will do the following with relative MIDI controller messages:

- *Session View Slots* – Value increment messages are treated like Note On messages. Value decrement messages are treated like Note Off messages.
- *Switches* – Increment messages turn the switch on. Decrement messages turn it off.
- *Radio Buttons* – Increment messages make the radio button jump forward to the next available option. Decrement messages make it jump backward.
- *Continuous Controls* – Each type of relative MIDI controller uses a different interpretation of the 0...127 MIDI controller value range to identify value increments and decrements:

Please consult the documentation that came with your MIDI controller if you need further information on relative MIDI controllers.

Relative Session View Navigation

Notice that you can make not only *absolute mappings* to individual slots and scenes, but also *relative mappings* to move the highlighted scene and operate on the highlighted clips.

In both MIDI Map Mode and **Key Map Mode**, a strip of assignable controls appears below the Session grid:

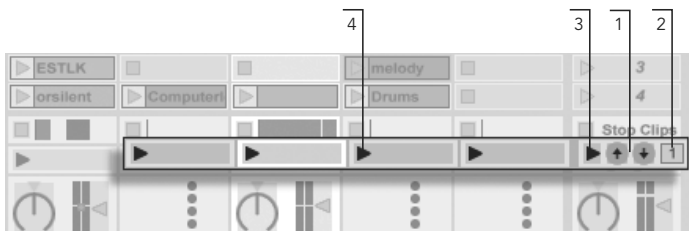

The Relative Session Mapping Strip.

1. Assign these buttons to keys, notes or controllers to move the highlighted scene up and down.
2. Assign this scene number value box to a MIDI controller – preferably an endless encoder – to scroll through the scenes. For details, see the previous section on **Relative Map Modes**.
3. Assign this button to launch the highlighted scene. If the Record/Warp/Launch Preferences' Select Next Scene on Launch option is checked, you can move successively (and hopefully successfully!) through the scenes.
4. Assign these buttons to launch the clip at the highlighted scene, in the respective track.

Relative Session mapping is useful for navigating a large Live Set, as Live always keeps the highlighted scene at the Session View's center.

Mapping to Clip View Controls

The **Clip View** displays the settings for whichever clip happens to be currently selected, but it will also display the settings of multi-selected clips. To avoid unpleasant musical surprises, it is important to remember that creating remote control mappings for any control in the

Clip View interface could potentially affect any clip in the Live Set. For this reason, we recommend mapping Clip View controls to **relative MIDI controllers** to prevent undesirable jumps in parameter values.

26.2.5 Computer Keyboard Remote Control

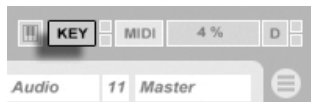

The Key Map Mode Switch.

Creating control surface assignments for your computer keyboard is straightforward:

1. Enter Key Map Mode by pressing the KEY switch in the upper right-hand corner of the Live screen. Notice that the assignable elements of the interface become highlighted in red when you enter Key Map Mode. The Mapping Browser will also become available. If the Browser is hidden, you will want to show it at this point using the appropriate View menu command.
2. Click on the Live parameter that you wish to assign to a key. Remember that only the controls that are shown with a red overlay are available for mapping.
3. Press the computer key to which you wish to assign the control. The details of your new mapping will be displayed in the Mapping Browser.
4. Leave Key Map Mode by pressing Live's KEY switch once again. The Mapping Browser will disappear, but your mappings can be reviewed at any time simply by entering Key Map Mode again.

Keyboard assignments can produce the following effects in Live:

- Clips in Session View slots will be affected by mapped keys according to their **Launch Mode settings**.
- Keys assigned to switches will toggle switch states.
- Keys assigned to radio buttons will toggle through the available options.

Please be sure not to confuse this remote control functionality with Live's ability to use the computer keyboard as a **pseudo-MIDI keyboard** that can generate MIDI notes from

computer keystrokes for use with instruments.

Chapter 27

Using the APC40

The APC40 (Ableton Performance Controller) is a dedicated controller for Ableton Live, co-designed by Ableton and [Akai Professional](#)¹. This chapter will help you set up your APC40, and introduce its capabilities.

27.1 Setup

Once the APC40 has been powered on and connected to your computer's USB port, you will need to select the APC40 in Live's Preferences. The APC40 is one of Live's [natively supported control surfaces](#), so setup is quite easy:

1. Open Live's Preferences from the Live menu in OS X, or the Options menu in Windows;
2. Go to the MIDI/Sync Tab;
3. Select the APC40 preset from the Control Surface chooser. Then select the port that the APC40 is connected to in the Input and Output choosers:

¹<http://www.akaipro.com>



Setting Up The APC40.

27.2 Clip Launch Matrix

The APC40's matrix of buttons gives you physical access to the clips in your [Session View](#). The matrix has 40 three-color buttons arranged in a five-scene-deep-by-eight-track-wide grid. The color-coding system lets you know exactly what is happening in each clip, and directional controls let you move around inside your Session View.



Session View Clip and Navigation Controls.

Pressing a Clip Launch button triggers the clip in the corresponding clip slot in Live. If the track is armed to record, pressing the button records a new clip.

The buttons in the matrix light up in different colors so you know what's going on:

- Amber: this slot contains a clip.
- Green: this clip is playing.
- Red: this clip is recording.

Many aspects of the Live interface are replicated in the APC40. You can stop all music in a track with its Clip Stop button and fire horizontal lines of clips with the Scene Launch buttons. Stop All Clips does just that.

The controller tells you what's going on in the software, but, importantly, the software also reflects what's happening on the controller. The clip slots currently being controlled by the

APC's button matrix are shown in Live with a red border.

The directional arrows and Shift button increase the scope of the eight-by-five grid:

- Pressing Up or Down moves you up or down one scene at a time. Hold the Shift button while hitting Up or Down to move five scenes up or down.
- The Left and Right arrow keys move you left or right one track at a time. Hold the Shift button while hitting Left or Right to move eight tracks at a time.

27.3 Session Overview

The APC40's Session Overview lets you navigate through large Live Sets quickly without looking at your computer screen. Hold down the Shift button and the matrix zooms out to reveal an overview of your Session View. In the Session Overview, each clip launch button represents a five-scene-by-eight-track block of clips, giving you a matrix of 125 scenes by 64 tracks. Hit a button to focus on that section of the Session View. For example, hitting the Shift button and then pressing the button in row three, column one will put the focus on scenes 11-15 and tracks 1-8. Furthermore, while Shift is held, each scene launch button represents a block of 25 scenes (if they are available in your Set.)

In the Session Overview, the color coding is a little different:

- Amber: indicates the currently selected block of clips, which will be surrounded by the red border in the software.
- Green: there are clips playing in that block of clips (though that may not be the block of clips selected).
- Red: there are no clips playing in that range.
- No color: there are no tracks or scenes in that range.

27.4 Mixer Section

The APC40 features eight tracks, each with its own fader, solo/pre-cue, mute and record arm buttons. A Master fader controls the master volume and a Cue Level knob controls **cue volume**, so you can pre-listen to a clip or the metronome without your audience hearing it.



Mixer Controls.

You can shift these eight tracks around the Session View using the directional controls. Press the right or left arrows to move incrementally, one track at a time. Hold the Shift button and press the right or left arrows to jump in blocks of eight tracks at a time.

27.5 Device Control

The APC40 features eight endless dials and four control buttons that **map to your devices automatically** for flexibility and speed on stage or in the studio.



Device Controls.

The Track Selection buttons route the eight endless encoders to the first device or Rack on that track, with LED rings to automatically show you the levels on the selected parameter.

Four buttons below the dials give you additional control options. Clip/Track lets you switch between viewing the devices on a track or the properties of the clip currently playing on that track. Device On/Off turns the currently selected device on or off. Device Left and Device Right (indicated by two arrows) shift you one step sideways along a track's device chain.

Some effects or virtual instruments have more than eight parameters. When holding down the Shift button, these eight buttons let you select eight banks of eight device parameter

controls. For more information, see the Control Surface Reference Lesson.

27.6 Transport and Global Buttons

Live's Play, Stop and Global Record buttons are all easily accessible, and four global buttons access Live's functions, cleaning up your screen view onstage and freeing you from the mouse in the studio:



Transport and Global Controls.

- Detail View opens and closes the **Clip/Track View**, so you can see more of your clips.
- Record Quantization lets you toggle **input quantization** between 'none' and the last selected quantization setting.
- MIDI Overdub lets you **overdub** on a MIDI clip.

- Metronome turns the **metronome** on and off.

27.7 Track Control

The Track Control section covers pan settings or send levels for whichever eight tracks are currently selected. It consists of eight endless dials with LED rings and four buttons: Pan, Send A, Send B and Send C.



Track Controls.

The buttons let you select what the encoders are controlling, while the encoders control the amount or depth of the pan or send levels.

27.8 Tempo Control

Tap Tempo and Nudge Left/Right buttons are essential for live performance, helping you to stay in sync with turntables, other musicians or a live band, and correct timing issues quickly.



Tempo Control.

As you hit the **Tap Tempo** button once every beat, the tempo of the Live Set will follow your tapping.

You can also use tapping to count in: If you are working in a 4:4 signature, it takes four taps to start song playback at the tapped tempo.

On stage and in the studio, you may find yourself in situations in which you need to adjust to sources that aren't locked to one tempo, such as live musicians or turntables. You can use the **Nudge** buttons to temporarily speed up or slow down Live's playback to match what you hear.

27.9 Crossfader

The APC40's replaceable crossfader is an essential DJ control, and is also handy for controlling effect, volume and modulation curves.



Crossfader.

In Live, you can set any track as an A or B destination, and then **crossfade** between the A and B selections.

Normal wear and tear can render a crossfader obsolete. The APC40's crossfader is fully replaceable from the bottom of the device, so you can extend the lifetime of this already durable unit.

27.10 Customizing the APC40 Controls

You can change the assignment of all of the knobs, faders and buttons on the APC40 by enabling the Remote switches in the MIDI/Sync Preferences, as described in the section on [manual control surface setup](#).

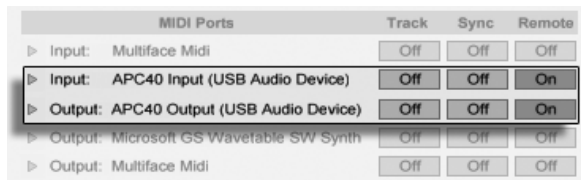

*Setting Up The APC40
For Custom
Assignments.*

Now, by entering Live's [MIDI Map Mode](#), you can override the pre-assigned functions of all of the APC40's knobs, faders and buttons. The eight Track Control knobs can be assigned in four banks, which can be switched with the buttons below them. Likewise, the Device Control knobs can be assigned in eight banks.

Tip: If you have overridden the APC40's default mappings with manual mappings, you can easily switch back to the defaults by deactivating the Remote switch of the APC40's input port. Activating the switch again will re-establish your manual mappings.

Chapter 28

Synchronization and ReWire

28.1 Synchronizing via MIDI

The MIDI protocol defines two ways to synchronize sequencers, both of which are supported by Live. Both protocols work with the notion of a *sync master*, which delivers a sync signal that is tracked by the *sync slave(s)*.

- **MIDI Clock.** MIDI Clock works like a metronome ticking at a fast rate. The rate of the incoming ticks is tempo-dependent: Changing the tempo at the sync master (e.g., a drum machine) will cause the slave to follow the change. The MIDI Clock protocol also provides messages that indicate the song position. With respect to MIDI Clock, Live can act as both a MIDI sync master and slave.
- **MIDI Timecode.** MIDI Timecode is the MIDI version of the SMPTE protocol, the standard means of synchronizing tape machines and computers in the audio and film industry. A MIDI Timecode message specifies a time in seconds and frames (subdivisions of a second). Live will interpret a Timecode message as a position in the Arrangement. Timecode messages carry no meter-related information; when slaving Live to another sequencer using MIDI Timecode, you will have to adjust the tempo manually. Tempo changes cannot be tracked. Detailed MIDI Timecode preferences

are explained **later in this chapter**. With respect to MIDI Timecode, Live can only act as a MIDI sync slave, not a master.

28.1.1 Synchronizing External MIDI Devices to Live

Live can send MIDI Clock messages to an external MIDI sequencer (or drum machine). After connecting the sequencer to Live and setting it up to receive MIDI sync, turn the device on as a sync destination in Live's MIDI/Sync Preferences.



Choosing a MIDI Slave for Live.

The lower indicator LED next to the Control Bar's EXT button will flash when Live is sending sync messages to external sequencers.

28.1.2 Synchronizing Live to External MIDI Devices

Live can be synchronized via MIDI to an external sequencer. After connecting the sequencer to Live and setting it up to send sync, use Live's MIDI/Sync Preferences to tell Live about the connection.



Setting up Live as a MIDI Slave.

When an external sync source has been enabled, the EXT button appears in the Control Bar. You can then activate external sync either by switching on this button or by using the External Sync command in the Options menu. The upper indicator LED next to the EXT button will flash if Live receives useable sync messages.



The External Sync Switch.

When Live is synced to an external MIDI device, it can accept song position pointers from this device, syncing it not only in terms of tempo but in terms of its position in the song. If the master jumps to a new position within the song, Live will do the same. However, if the Control Bar's Loop switch is activated, playback will be looped, and song position pointers will simply be "wrapped" into the length of the loop.

28.1.3 MIDI Timecode Options

Timecode options can be set up per MIDI device. Select a MIDI device from the MIDI/Sync Preferences' MIDI Ports list to access the settings.

The *MIDI Timecode Frame Rate* setting is relevant only if "MIDI Timecode" is chosen from the MIDI Sync Type menu. The MIDI Timecode Rate chooser selects the type of Timecode to which Live will synchronize. All of the usual SMPTE frame rates are available. When the Rate is set to "SMPTE All," Live will auto-detect the Timecode format of incoming sync messages and interpret the messages accordingly. Note that you can adjust the Timecode format that is used for display in the Arrangement View: Go to the Options menu, and then access the Time Ruler Format sub-menu.

The *MIDI Timecode Offset* setting is also only relevant if "MIDI Timecode" is chosen from the Sync Type menu. You can specify a SMPTE time offset using this control. Live will interpret this value as the Arrangement's start time.

28.1.4 Sync Delay

The *Sync Delay* controls, which are separately available for each MIDI device, allow you to delay Live's internal time base against the sync signal. This can be useful in compensating for delays incurred by the signal transmission. The Sync Delay for a specific MIDI device appears as you select the MIDI device from the MIDI/Sync Preferences' MIDI Ports list. To adjust the delay, have both Live and the other sequencer play a rhythmical pattern with

pronounced percussive sounds. While listening to the output from both, adjust the Sync Delay control until both sounds are in perfect sync.



Adjusting Sync Delay.

28.2 Connecting via ReWire

Live supports the *ReWire* interface for connecting with another ReWire-compatible audio program running on the same computer.

The ReWire technology, developed by *Propellerhead Software*, provides ReWire-compatible programs with:

- common access to the audio hardware;
- shared transport functionality;
- synchronization to audio word clock and song positioning;
- exchange of audio streams.

The programs in a ReWire connection play distinct roles: The *ReWire master* accesses the audio hardware and provides mixing facilities; the *ReWire slave(s)* have no direct link to the audio hardware, but instead send their audio output into the Master's mixer.

Common ReWire master applications are Digidesign Pro Tools, Steinberg Cubase and Nuendo, Emagic Logic Audio, MOTU Digital Performer, Cakewalk Sonar and Cycling 74 Max/MSP. Common ReWire slave applications are Propellerheads Rebirth, Propellerheads Reason, Arturia Storm, Cakewalk Project 5 and Cycling 74 Max/MSP. Live can act as both a ReWire master and slave.

Note that the ReWire protocol itself does not consume much CPU power. However, as expected, running two audio-intensive programs on the same computer requires more

resources than running a single program.

28.2.1 Running Live in ReWire Master Mode

The step-by-step procedure for sending MIDI to and receiving audio from a ReWire slave program is presented in the [routing chapter](#).

28.2.2 Running Live in ReWire Slave Mode

In ReWire slave mode, Live can both receive MIDI from, but also send audio to the master application. All of Live's MIDI tracks are accessible to the master application as destinations for MIDI signals, and all of its audio tracks and MIDI tracks containing instruments are accessible as audio sources.

If you have not used Live yet, please launch Live so that it can install its ReWire engine in your system.

Live will run in ReWire slave mode if it detects a running ReWire master application upon startup. Therefore, always start the ReWire master application first, and then start Live.

Likewise, you will first have to quit Live, then the ReWire master application.

Live's operation in ReWire slave mode differs from the usual operation in some regards:

- Live will not have direct access to the audio interfaces; audio input/output is handled by the ReWire master application. No audio input will be available to Live.
- The sample rate is determined by the host application rather than by Live.
- External synchronization will be disabled (synchronize to the ReWire master application instead). Live will not send sync or controller messages to the MIDI output. Controlling Live via MIDI is still possible.
- Live will not act as a ReWire master application. For instance, you cannot run Rebirth as a ReWire slave of Live while Live is running as a ReWire slave of Cubase. You can, however, run both Live and Rebirth as ReWire slaves of Cubase at the same time.

- Time signature and tempo will be determined by the settings in the ReWire master application. If your Live Set contains any tempo or time signature changes, they will be ignored.

28.2.3 More on ReWire

You can find tutorials on connecting Live to specific ReWire master programs at the [Ableton tutorial website](#)¹.

The [Ableton FAQ website](#)² is the first place to go if you encounter ReWire-related problems.

If you cannot seem to find an answer there, please contact the [Ableton support team](#)³.

¹<http://www.ableton.com/tutorials>

²<http://www.ableton.com/faq>

³<http://www.ableton.com/support>

Chapter 29

Computer Audio Resources and Strategies

Real-time audio processing is a demanding task for general-purpose computers, which are usually designed to run spreadsheets and surf the Internet. An application like Live requires a powerful CPU and a fast hard disk. This section will provide some insight on these issues, and should help you avoid and solve problems with running audio on a computer.

29.1 Managing the CPU Load

To output a continuous stream of sound through the audio hardware, Live has to perform a huge number of calculations every second. If the processor can't keep up with what needs to be calculated, the audio will have gaps or clicks. Factors that affect computational speed include processor clock rates (e.g., speed in MHz or GHz), architecture, memory cache performance (how efficiently a processor can grab data from memory) and system bus bandwidth – the computer's "pipeline" through which all data must pass. For this reason, many people involved with pro audio use computers that are optimized for musical applications.

Fortunately, Live supports multicore and multiprocessor systems, allowing the processing load from things like instruments, effects and I/O to be distributed among the available resources. Depending on the machine and the Live Set, the available processing power can be several times that of older systems.

If you are working on a multicore or multiprocessor system, you will want to enable support for it in the CPU tab of Live's Preferences.

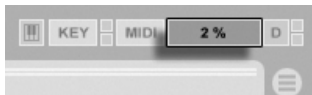

The CPU Load Meter.

The Control Bar's CPU meter displays how much of the computer's computational potential is currently being used. For example, if the displayed percentage is 10 percent, the computer is just coasting along. If the percentage is 100 percent, the processing is being maxed out – it's likely that you will hear gaps, clicks or other audio problems. Note that the CPU meter takes into account only the load from processing audio, not other tasks the computer performs (e.g., managing Live's user interface).

Audio calculations have the highest priority in Live. Therefore, even if the CPU shows a high percentage of processor usage, the audio stream should remain uninterrupted. However, non-critical functions (such as screen redraws) might slow down because these tasks are handled only when the audio processing "lightens up" a bit.

29.1.1 CPU Load from Multichannel Audio

One source of constant CPU drain is the process of moving data to and from the audio hardware. This drain can be minimized by disabling any inputs and outputs that are not required in a project. There are two buttons in the Audio Preferences to access the Input and Output Configuration dialogs, which allow activating or deactivating individual ins and outs.

Live does not automatically disable unused channels, because the audio hardware drivers usually produce an audible "hiccup" when there is a request for an audio configuration change.



29.1.2 CPU Load from Tracks and Devices

Generally, every track and device being used in Live incurs some amount of CPU load. However, Live is “smart” and avoids wasting CPU cycles on tracks and devices that do not contribute anything useful.

For example, dragging devices into a Live Set that is not running does not significantly increase the CPU load. The load increases only as you start playing clips or feed audio into the effects. When there is no incoming audio, the effects are deactivated until they are needed again. (If the effect produces a “tail,” like reverbs and delays, deactivation occurs only after all calculations are complete.)

While this scheme is very effective at reducing the average CPU load of a Live Set, it cannot reduce the peak load. To make sure your Live Set plays back continuously, even under the most intense conditions, play back a clip in every track simultaneously, with all devices enabled.

29.1.3 Track Freeze

Live’s Freeze Track command can greatly help in managing the CPU load incurred by devices and clip settings. When you select a track and execute the Freeze Track command, Live will create a sample file for each Session clip in the track, plus one for the Arrangement. Thereafter, clips in the track will simply play back their “freeze files” rather than repeatedly calculating processor-intensive device and clip settings in real time. The Freeze Track command is available from Live’s Edit menu and from the  (PC) /  (Mac) context menu of tracks and clips. Be aware that it is not possible to freeze a **Group Track**; you can only freeze tracks that hold clips.

Normally, freezing happens very quickly. But if you freeze a track that contains an **External Audio Effect** or **External Instrument** that routes to a hardware effects device or synthesizer, the freezing process happens in real-time. Live will automatically detect if real-time freezing is necessary, and you’ll be presented with several options for managing the process. Please see the section on **real-time rendering** for an explanation of these options.

Once any processing demands have been addressed (or you have upgraded your machine!), you can always select a frozen track and choose Unfreeze Track from the Edit menu to change

device or clip settings. On slower machines, you can unfreeze processor-intensive tracks one at a time to make edits, freezing them again when you are done.

Many editing functions remain available to tracks that are frozen. Launching clips can still be done freely, and mixer controls such as volume, pan and the sends are still available. Other possibilities include:

- Edit, cut, copy, paste, duplicate and trim clips;
- Draw and edit mixer automation and mixer clip envelopes;
- Consolidate;
- Record Session View clip launches into the Arrangement View;
- Create, move and duplicate Session View scenes;
- Drag frozen MIDI clips into audio tracks.

When performing edits on frozen tracks that contain time-based effects such as reverb, you should note that the audible result may be different once the track is again unfrozen, depending on the situation. This is because, if a track is frozen, the applied effects are not being calculated at all, and therefore cannot change their response to reflect edited input material. When the track is again unfrozen, all effects will be recalculated in real time.

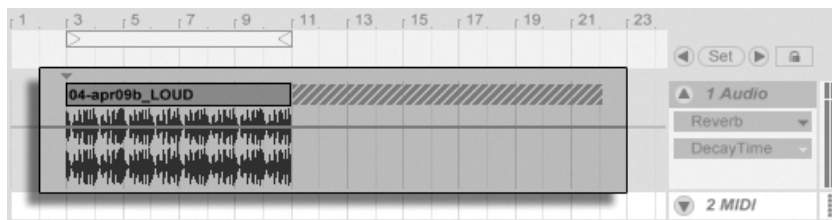

A Frozen Arrangement Track with a Reverb Tail.

Frozen Arrangement View tracks will play back any relevant material extending beyond the lengths of their clips (e.g., the “tails” of Reverb effects). These frozen tails will appear in the Arrangement as crosshatched regions located adjacent to their corresponding clips. They are treated by Live as separate, “temporary” clips that disappear when unfrozen, since the effect is then calculated in real time. Therefore, when moving a frozen clip in the Arrangement, you will usually want to select the second, frozen *tail* clip as well, so that the two remain together.

For frozen Session clips, only two loop cycles are included in the frozen clip, which means that clips with **unlinked clip envelopes** may play back differently after two loop cycles when frozen.

The samples generated by the Freeze Track command are stored in your temporary recording folder until you save your Live Set, at which point they are moved to the following **project folder** sub-directory: Samples/Processed/Freeze. Please note that freeze files for tracks that contain an External Instrument or External Audio Effect will be discarded immediately when unfreezing.

You can also decide to *flatten* frozen tracks, which completely replaces the original clips and devices with their audible result. The Flatten command is available from the Edit menu.

Besides providing an opportunity to conserve CPU resources on tracks containing a large number of devices, the Track Freeze command simplifies sharing projects between computers. Computers that are a bit low on processing power can be used to run large Live Sets as long as any CPU-intensive tracks are frozen. This also means that computers lacking certain devices used in one Live Set can still play the Set when the relevant device tracks are frozen.

29.2 Managing the Disk Load

A hard drive's access speed (which is related to, but not the same thing as rotational speed) can limit Live's performance. Most audio-optimized computers use 7200 RPM or faster drives. Laptops, to save power, often use 5400 RPM or slower drives, which is why projects on laptops usually have lower track counts. The amount of disk traffic Live generates is roughly proportional to the number of audio channels being written or read simultaneously. A track playing a stereo sample causes more disk traffic than a track playing a mono sample.

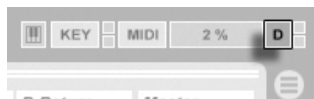

The Disk Overload Indicator.

The Disk Overload indicator flashes when the disk was unable to read or write audio quickly enough. When recording audio, this condition causes a gap in the recorded sample; when playing back, you will hear dropouts.

Do the following to avoid disk overload:

- Reduce the amount of audio channels being written by choosing mono inputs instead of stereo inputs in the Audio Preferences' Channel Configuration dialog.
- Use **RAM Mode** for selected clips.
- Reduce the number of audio channels playing by using mono samples instead of stereo samples when possible. You can convert stereo samples to mono using any standard digital audio editing program, which can be called up from **within Live**.

Chapter 30

Audio Fact Sheet

Prior to the release of Live 7, much of Ableton’s development effort was focused on carefully and objectively testing Live’s fundamental audio performance. As a result of this testing, we have implemented a number of low-level improvements to the audio engine. We have also written this fact sheet to help users understand exactly how their audio is (or is not) being modified when using certain features in Live that are often misunderstood, as well as tips for achieving the highest quality results.

As mentioned above, the focus of our research has been on objective (that is, quantifiable and measurable) behavior. We make no claims about what you can *hear* because we can’t possibly predict the variables that make up your listening environment, audio hardware, hearing sensitivity, etc. Furthermore, this paper makes no claims about how Live compares to other audio software. Rather, it is a summary of measurable facts about what Live actually does under various conditions.

30.1 Testing and Methodology

As of this writing, every version of Live is subjected to a suite of 473 automated tests that cover every aspect of Live’s functionality. We add additional tests as we add features, and

we will never release an update unless it passes every test.

30.2 Neutral Operations

Procedures in Live that will cause absolutely no change in audio quality are referred to as *neutral operations*. You can be sure that using these functions will never cause any signal degradation. Applying neutral operations to audio that was recorded into Live ensures that the audio will be unchanged from the point of analog-to-digital conversion. Applying neutral operations to files imported into Live ensures that the imported audio will be identical to the files saved on disk. Applying neutral operations to files being exported from Live ensures that the quality of your output file will be at least as high as what you heard during playback.

The list of neutral operations found below is provided primarily as an abstract reference; while all of these operations are, in fact, neutral, it is important to remember that each of them may (and almost certainly will) occur within a context that also contains non-neutral operations. For example, running an audio signal through an effects device is a non-neutral operation. So any neutral operations that occur after it will, of course, still result in audio that is altered in some way. Even a gain change is, technically, non-neutral.

Neutral operations include:

30.2.1 Undithered Rendering

The **Export Audio/Video** command renders Live's audio output to a file on disk. Rendering is a neutral operation under certain conditions:

- the sample rate of the rendered file is the same as that set for the audio hardware in Live's Preferences.
- no non-neutral operations have been applied.

Live's rendering performance is tested by loading three types of unprocessed audio files (white noise, fixed-frequency sine waves and sine sweeps) in 16-, 24- and 32-bit word lengths and rendering these to output files, also with varying bit resolutions. Phase cancellation testing of the original and output files shows the following:

- rendering to a file with the same bit depth as the original results in complete phase cancellation.
- rendering to a file with a higher bit depth than the original results in complete phase cancellation.
- rendering to a file with a lower bit depth than the original results in the smallest amount of distortion possible within a 32-bit system.

30.2.2 Matching sample rate/no transposition

Playback of an unstretched audio file in Live is a neutral operation, provided that the file's sample rate is the same as that set in Live's Preferences and that the file is played back without transposition. This is verified by cancellation tests of rendered output. Please note that "playback" in this context refers only to the audio within Live, prior to the point at which it reaches your audio hardware.

30.2.3 Unstretched Beats/Tones/Texture/Re-Pitch Warping

If the tempo of a Clip is the same as the tempo of the Set, that clip will play back unstretched. In this case, if the **Warp mode** of the Clip is set to Beats, Tones, Texture or Re-Pitch (but not Complex or Complex Pro), playback will be neutral. Any Warping caused by changing the Set's tempo is non-permanent, and audio that plays back unwarped at a given tempo will always play back unwarped at that tempo, even if the tempo is changed and then changed back. For example, if you've recorded some tracks at 120 BPM, but then decide you'd like to slow the tempo down to record a particularly difficult solo passage, the original tracks will play back neutrally again after returning the tempo to 120 BPM. Only the recording made at the slower tempo will be stretched. Please note that **grooves** work by modifying the positions of Warp markers. This means that playback of audio clips with groove applied will be non-neutral even at the original tempo.

The neutrality of unstretched clip playback is verified by performing cancellation tests on rendered output.

30.2.4 Summing at Single Mix Points

Since version 7, Live uses double precision (64-bit) summing at all points where signals are mixed, including Clip and return track inputs, the Master track and Racks. Mixing in Live is thus a neutral operation for signals mixed at any single summing point. This is tested by loading pairs of 24-bit files (white noise and fixed-frequency sine waves and their phase-inverted complements), adding the pairs together eight times and rendering the output as 32-bit files. All tests result in perfect phase cancellation.

Please note that, while 64-bit summing is applied to each *single* mix point, Live's internal processing is still done at 32-bit. Thus, signals that are mixed across multiple summing points may still result in an extremely small amount of signal degradation. This combination of 64-bit summing within a 32-bit architecture strikes an ideal balance between audio quality and CPU/memory consumption.

30.2.5 Recording external signals (bit depth \geq A/D converter)

Recording audio signals into Live is a neutral operation, provided that the bit depth set in Live's Preferences window is the same or higher than that of the A/D converters used for the recording. In this context, "neutral" means "identical to the audio as it was delivered to Live by the A/D converters."

30.2.6 Recording internal sources at 32 bit

Audio that is recorded via internal routing will be identical to the source audio, provided that the recording was made at 32 bits. To ensure neutral recordings of plug-in instruments and any audio signals that are being processed by effects plug-ins, internal recording at 32 bits is recommended. Please note, however, that if the source audio is already at a lower bit depth, internal recording at that bit depth will also be neutral (assuming that no effects are used); internally recording an unprocessed 16 bit audio file at 32 bits will not increase the sound quality.

The neutrality of internal recording is verified using cancellation tests.

30.2.7 Freeze, Flatten

When tracks are **frozen**, the audio files that are created are 32 bit, which ensures that they will not be lower quality than the audio heard prior to freezing. But there are some special cases involving Freeze that result in non-neutral behavior and should be noted:

- Frozen Arrangement View tracks can include audio material that extends beyond the end of the clip itself, such as reverb tails and delay repetitions. Frozen Session View tracks, however, are always exactly two loop cycles long, so any audio that extends beyond two loop cycles during un-frozen playback will be cut off after freezing.
- Time-based effects like reverbs and delays are processed in realtime for unfrozen clips, so stopping playback during a reverb or delay tail will allow the tail to continue. In contrast, frozen tails are rendered as audio, and so will stop abruptly during playback.
- Any parameter automations are rendered as part of the audio file for frozen Arrangement View clips. Frozen Session View clips, however, take a “snapshot” of all parameter values at the Arranger’s 1.1.1 position and retain them for the duration of the frozen clip. This is analogous to the behavior with unfrozen clips; when playing normal clips in Session View, any Arrangement automations are “punched out” until the Back to Arrangement button is pressed.
- Frozen clips are always played back with Warp on and in Beats mode, which means they are subject to the same non-neutral behavior as any other Warped audio files.
- Any devices with random parameters (e.g., the Chance control in the Beat Repeat device) will no longer exhibit random behavior after freezing. This is because, as with time-based effects, the random values that were in place at the moment of freezing will be rendered as part of the new file, and will thus no longer be calculated in real-time.

Please note that the Flatten command replaces any original clips and devices with the audio files created by freezing. When using this command, it is important to keep in mind the special cases above – what you hear after freezing is exactly what you will get when flattening, so if the results are not to your liking, be sure to unfreeze and make any necessary changes to device parameters before invoking the Flatten command.

This procedure is tested by rendering the output of an audio track and comparing it to the frozen audio from the same track via phase cancellation to ensure that the files are identical.

30.2.8 Bypassed Effects

Bypassed effects in Live are removed from the signal flow. This is true for both Live's built-in effects devices and third-party VST and AU plug-ins. Consequently, audio at the output of a bypassed effect is identical to the audio at the input. Please note, however, that effects devices with parameters that inherently require delay (e.g., the Look Ahead settings in Compressor) will still introduce this delay when bypassed, in order to maintain automatic delay compensation with the rest of the project. In most cases, the effects of this behavior will be completely inaudible.

The neutrality of bypassed effects is tested by loading one instance of each of Live's effects devices into an audio track, deactivating them, and then rendering the output of the track. The rendered file is then compared to the rendered output of the same track with no loaded devices. Phase cancellation testing of the two files confirms that they are identical.

30.2.9 Routing

The **routing** of signals within Live is a neutral operation. The signal at the routing destination will be identical to the signal at the routing source. It is important to note that Live's flexible routing architecture allows for a variety of scenarios, including routing from before or after any track's effects or mixer and tapping the output of individual sample slots within the Impulse instrument. In these cases, it is likely that the signal heard at the output point will be different from the signal heard prior to routing, because it has been tapped before reaching the end of its original signal chain.

30.2.10 Splitting Clips

Clips which are already neutral will remain neutral after **splitting**. Splitting only affects playback position within the sample, and has no effect on the sample data itself. Playback across a split boundary is seamless and sample-accurate.

The neutrality of clip splitting is tested under a variety of conditions:

- splitting unwarped clips with loop on and off;
- splitting warped but unstretched clips with loop on and off;

In all cases, output is rendered and compared with the output of an unsplit version of the same source. Phase cancellation testing of the two files confirms that they are identical.

30.3 Non-Neutral Operations

Procedures in Live that will cause a change in audio quality are referred to as *non-neutral operations*. Users can be guaranteed that using these operations will cause at least some change to the signal. Applying non-neutral operations to files imported into Live ensures that the imported audio will differ from the files saved on disk. Applying non-neutral operations to files being exported from Live ensures that what you hear during realtime playback will be different from what will end up in your new file.

Non-neutral operations include:

30.3.1 Playback in Complex and Complex Pro Mode

The algorithms used in the **Complex** and **Complex Pro** Warp modes use an entirely different technology from the algorithms behind Beats, Tones and Texture modes. Although the Complex modes may sound better, particularly when used with mixed sound files containing many different kinds of audio material, they are never neutral – not even at the original tempo. Because of this, and because of the increased CPU demands of these algorithms, we recommend using them only in cases where the other Warp modes don't produce sufficient results.

30.3.2 Sample rate conversion/transposition

Sample rate conversion (during both real-time playback and rendering) is a non-neutral operation. Playback of audio files at a sample rate that is different from the rate set in Live's Preferences window will cause signal degradation. Transposition is also a form of sample-rate conversion, and thus also results in non-neutral behavior.

To minimize potential negative results, it is recommended to do sample rate conversion as an offline process in another application. Once the samples have been converted to the

sample rate that you plan to use in Live, the files can be imported without any loss of quality.

Rendering audio from Live with a sampling rate other than the one that was used while working on the project is also a non-neutral operation, and may result in a loss of sound quality. It is recommended to always render using the original sampling rate, and then convert the rendered file using a dedicated mastering application that is optimized for these kinds of CPU-intensive, offline tasks.

While we recommend that you use a high-quality offline tool for sample rate conversion, we recognize that one of Live's core features is its ability to pitch-shift and warp audio in real time. For this situation, it is necessary to make a trade-off between CPU performance and precision. We recommend the use of the **Hi-Q** button for any clips which undergo transposition in a given Set. The algorithm behind the Hi-Q switch was rewritten for Live 7, and now results in considerably lower distortion than in previous versions.

30.3.3 Volume Automation

Automation of volume level results in a change in gain, which is necessarily a non-neutral operation. But certain implementations of automation envelopes can result in audible artifacts, particularly if the envelopes are not calculated at a fast enough rate. Since Live 7, volume automation curves are updated for each audio sample, resulting in extremely low levels of distortion.

30.3.4 Dithering

Whenever rendering audio to a lower bit depth, it is a good idea to apply dithering in order to minimize artifacts. Dithering (a kind of very low-level noise) is inherently a non-neutral procedure, but it is a necessary evil when lowering the bit resolution.

Please note that Live's internal signal processing is all 32-bit, so applying even a single gain change makes the resulting audio 32-bit as well – even if the original audio is 16- or 24-bit. Dither should never be applied more than once to any given audio file, so unless you are mastering and finalizing in Live, it is best to always render at 32-bit and avoid dithering altogether.

30.3.5 Recording external signals (bit depth < A/D converter)

Recording audio signals into Live is a non-neutral operation if the bit depth set in Live's Preferences window is lower than that of the A/D converters used for the recording. This is not recommended.

30.3.6 Recording internal sources below 32 bit

Audio that is recorded via internal routing will lose quality if the recording is made at a bit depth below 32 bits. To ensure neutral recordings of plug-in instruments and any audio signals that are being processed by effects plug-ins, internal recording at 32 bits is recommended. Please note, however, that if the source audio is already at a lower bit depth, internal recording at that bit depth will also be neutral (assuming that no effects are used); internally recording an unprocessed 16 bit audio file at 32 bits will not increase the sound quality.

30.3.7 Consolidate

Consolidating clips in the Arrangement View creates new audio files, which are non-neutral in comparison to the original audio data. Specifically, the new files will be normalized, with their clip volumes adjusted to play back at the same volume as heard prior to consolidation. Normalization is a gain change, which is a non-neutral operation. Also, the new files will be created at the sample rate and bit depth set in Live's Preferences window, which may differ from those in the original audio files.

30.3.8 Clip fades

When Create Fades on Clip Edges is enabled in the Record/Warp/Launch Preferences, a short (up to 4 ms) fade is applied to the clip start and end to avoid clicks at the clip edges. These "declicking" fades can also be applied to Session View clips via the **Clip Fade** button. Additionally, Arrangement View clips have **editable fades and crossfades**. Applying any of these fade options is a non-neutral operation.

30.3.9 Panning

Live uses constant power panning with sinusoidal gain curves. Output is 0 dB at the center position and signals panned fully left or right will be increased by +3 dB. In order to minimize this volume change, it may be helpful to narrow the overall stereo width before doing extreme panning. This can be done via the Width control in the Utility device.

30.3.10 Grooves

Under most conditions, playback of a warped clip that is at the same tempo as the Set is a neutral operation. However, if a **groove** is applied, playback will be non-neutral at any tempo.

30.4 Tips for Achieving Optimal Sound Quality in Live

For users looking to achieve optimal audio quality in Live, we have provided a list of recommended practices and program settings.

- Decide which sample rate to use for a project prior to beginning work, rather than changing the sample rate while working on the project.
- Record audio into Live using high-quality hardware components (audio interface, cables, etc.) and at the highest sample rate and bit depth your interface and computer will support.
- Avoid using samples that are at different sample rates within the same project. If you want to work with such files, we recommend that you first convert them to the sample rate set for your audio interface in an offline application that is optimized for this task.
- For all audio clips, disable both the Warp and Fade options in the Clip View.
- Do not adjust the Transpose and Detune controls for any clips.
- Always render at 32-bit and at the sample rate set for your audio interface. If you need audio files at a different sample rate and/or bit depth, we recommend that you

convert your rendered files in an offline application that is optimized for these tasks, rather than in Live.

Please note that these practices, while ensuring optimal audio quality, disable some of Live's functionality – in particular, stretching and synchronization.

30.5 Summary and Conclusions

Ableton wrote this paper in order to help users understand exactly how audio is affected when performing various procedures in Live. Our focus has been on functions that have proven over the years to cause confusion or uncertainty, and the list of both neutral and non-neutral operations presented here is necessarily incomplete.

We encourage you to refer to this paper if you have any questions about the functions discussed, but we also encourage you to [contact us](#)¹ if you have additional questions that we haven't answered. Live is a product, but it is also an ongoing process, and one that benefits greatly from user input.

¹contact@ableton.com

Chapter 31

MIDI Fact Sheet

In conjunction with our work on the audio engine, Ableton has spent additional effort analyzing Live's MIDI timing and making improvements where necessary. We wrote this fact sheet to help users understand the problems involved in creating a reliable and accurate computer-based MIDI environment, and to explain Live's approach to solving these problems.

Note: the MIDI timing issues discussed in this paper are generally not applicable to users with high-quality audio and MIDI hardware. If you have already invested time and money into optimizing these factors in your studio, and are not experiencing problems with MIDI timing, you probably do not need this information.

31.1 Ideal MIDI Behavior

To understand how MIDI works within a digital audio workstation (DAW), it is helpful to introduce some common terms and concepts. A DAW must be able to accommodate three distinct MIDI-related scenarios:

- 1) *Recording* refers to sending MIDI note and controller information from a hardware device (such as a MIDI keyboard) into a DAW for storage. An ideal recording

environment would capture this incoming information with perfect timing accuracy in relation to the timeline of the song – as accurately as an audio recording.

- 2) *Playback* refers to two related scenarios when dealing with DAWs. The first involves sending MIDI note and controller information from the DAW to a hardware device such as a synthesizer. The second involves converting stored MIDI information into audio data within the computer, as played back by a plug-in device such as the Operator synthesizer. In both cases, an ideal playback environment would output a perfect reproduction of the stored information.
- 3) *Playthrough* involves sending MIDI note and controller information from a hardware device (such as a MIDI keyboard) into the DAW and then, in real-time, back out to a hardware synthesizer or to a plug-in device within the DAW. An ideal playthrough environment would “feel” as accurate and responsive as a physical instrument such as a piano.

31.2 MIDI Timing Problems

The realities of computer-based MIDI are complex, and involve so many variables that the ideal systems described above are impossible to achieve. There are two fundamental issues:

- 1) *Latency* refers to inherent and consistent delay in a system. This is a particular problem in a DAW because digital audio cannot be transferred into or out of an audio interface in real time, and must instead be buffered. But even acoustic instruments exhibit a certain degree of latency; in a piano, for example, there is some amount of delay between the time a key is depressed and the time the hammer mechanism actually activates the string. From a performance perspective, small latency times are generally not a problem because players are usually able to adapt the timing of their playing to compensate for delays – as long as the delays remain consistent.
- 2) *Jitter* refers to inconsistent or random delay in a system. Within a DAW, this can be a particular problem because different functions within the system (e.g., MIDI, audio and the user interface) are processed separately. Information often needs to be moved from one such process to another – when converting MIDI

data into a plug-in's playback, for example. Jitter-free MIDI timing involves accurate conversion between different clocks within the system's components – the MIDI interface, audio interface, and the DAW itself. The accuracy of this conversion depends on a variety of factors, including the operating system and driver architecture used. Jitter, much more so than latency, creates the feeling that MIDI timing is “sloppy” or “loose.”

31.3 Live's MIDI Solutions

Ableton's approach to MIDI timing is based on two key assumptions:

1. In all cases, latency is preferable to jitter. Because latency is consistent and predictable, it can be dealt with much more easily by both computers and people.
2. If you are using playthrough while recording, you will want to record what you *hear* – even if, because of latency, this occurs slightly later than what you *play*.

Live addresses the problems inherent in recording, playback and playthrough so that MIDI timing will be responsive, accurate and consistently reliable. In order to record incoming events to the correct positions in the timeline of a Live Set, Live needs to know exactly when those events were received from the MIDI keyboard. But Live cannot receive them directly – they must first be processed by the MIDI interface's drivers and the operating system. To solve this problem, the interface drivers give each MIDI event a *timestamp* as they receive it, and those are passed to Live along with the event so that Live knows exactly when the events should be added to the clip.

During playthrough, a DAW must constantly deal with events that should be heard as soon as possible, but which inevitably occurred in the past due to inherent latency and system delays. So a choice must be made: should events be played at the moment they are received (which can result in jitter if that moment happens to occur when the system is busy) or should they be delayed (which adds latency)? Ableton's choice is to add latency, as we believe that it is easier for users to adjust to consistent latency than to random jitter.

When monitoring is enabled during recording, Live adds an additional delay to the timestamp of the event based on the buffer size of your audio hardware. This added latency makes it possible to record events to the clip at the time you *hear* them – not the time you *play* them.

For playback of hardware devices, Live also generates timestamps that it attempts to communicate to the MIDI interface drivers for scheduling of outgoing MIDI events. Windows MME drivers cannot process timestamps, however, and for devices that use these drivers, Live schedules outgoing events internally.

Even during high system loads that cause audio dropouts, Live will continue to receive incoming MIDI events. In the event of audio dropouts, there may be timing errors and audio distortion during playthrough, but Live should still correctly record MIDI events into clips. Later, when the system has recovered from the dropouts, playback of these recorded events should be accurate.

31.4 Variables Outside of Live's Control

In general, timestamps are an extremely reliable mechanism for dealing with MIDI event timing. But timestamps are only applicable to data within the computer itself. MIDI data outside of the computer can make no use of this information, and so timing information coming from or going to external hardware is processed by the hardware as soon as it arrives, rather than according to a schedule. Additionally, MIDI cables are *serial*, meaning they can only send one piece of information at a time. In practice, this means that multiple notes played simultaneously cannot be transmitted simultaneously through MIDI cables, but instead must be sent one after the other. Depending on the density of the events, this can cause MIDI timing problems.

Another issue that can arise, particularly when working with hardware synthesizers from the early days of MIDI, is that the *scan time* of the device may occur at a relatively slow rate. Scan time refers to how often the synthesizer checks its own keyboard for input. If this rate is too slow, jitter may be introduced.

Of course, any such timing problems present at the hardware level may be multiplied as additional pieces of gear are added to the chain.

Even within the computer, the accuracy of timestamps can vary widely, depending on the quality of the MIDI hardware, errors in driver programming, etc. Live must assume that any timestamps attached to incoming MIDI events are accurate, and that outgoing events will be dealt with appropriately by any external hardware. But both situations are impossible for Live to verify.

31.5 Tests and Results

Our procedure for testing the timing of incoming MIDI events is represented in the following diagram:

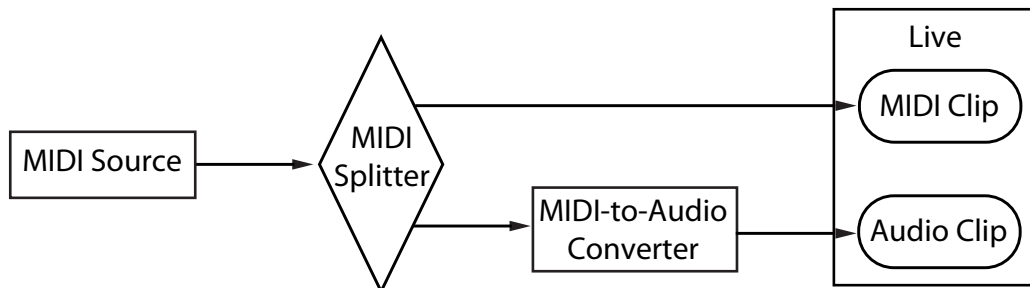

MIDI Input Test Configuration.

The output of a *MIDI Source* (a keyboard or other DAW playing long sequences of random MIDI events) is fed to a zero-latency hardware *MIDI Splitter*. One portion of the splitter's output is recorded into a new MIDI clip in Live. The other portion is fed to a *MIDI-to-Audio Converter*. This device converts the electrical signal from the MIDI source into simple audio noise. Because the device does not interpret the MIDI data, it performs this conversion with zero-latency. The converter's output is then recorded into a new audio clip in Live. In an ideal system, each event in the MIDI clip would occur simultaneously with the corresponding event in the audio clip. Thus the difference in timing between the MIDI and audio events in the two clips can be measured to determine Live's accuracy.

In order to assess MIDI performance under a variety of conditions, we ran the tests with three different audio/MIDI combo interfaces at different price points, all from well-known manufacturers. We will refer to these interfaces as A, B and C. All tests were performed with a CPU load of approximately 50% on both OS X and Windows machines, at both 44.1 and 96 kHz and at three different audio buffer sizes, for a total of 36 discrete test configurations.

Windows:

- Interface A: The maximum jitter was +/- 4 ms, with the majority of the jitter occurring at +/- 1 ms.
- Interface B: For most of the tests, the maximum jitter was +/- 3 or 4 ms. At 96 kHz and 1024 sample buffer, there were a small number of events with +/- 5 ms of jitter.

At 44.1 kHz and 512 sample buffer, occasional events with +/- 6 ms occurred. In all cases, the majority of the jitter occurred at +/- 1 ms.

- Interface C: For most of the tests, the maximum jitter was +/- 5 ms. At 96 kHz and 512 sample buffer, there were a small number of events with between +/- 6 and 8 ms of jitter. At 44.1 kHz and 1024 sample buffer, there were a small number of events with jitter as high as +/- 10 ms. In all cases, the majority of the jitter occurred at +/- 1 ms.

OS X:

- Interface A: At 44.1 kHz and 1152 sample buffer, jitter was fairly evenly distributed between +/- 4 and 11 ms. For all other tests, the maximum jitter was +/- 5 ms. In all tests, the majority of the jitter occurred at +/- 1 ms.
- Interface B: For most of the tests, the maximum jitter was +/- 4 or 5 ms. At 44.1 kHz and 1152 sample buffer, there was a fairly even distribution of jitter between +/- 2 and 11 ms. In all cases, the majority of the jitter occurred at +/- 1 ms.
- Interface C: In all tests, the maximum jitter was +/- 1 ms, with most events occurring with no jitter.

We also performed a similar procedure for testing the timing of outgoing MIDI events, as represented in the following diagram:

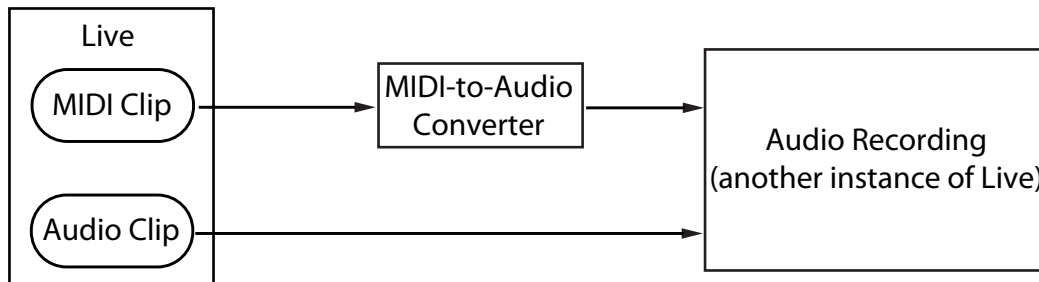

MIDI Output Test Configuration.

In all cases, the output tests showed comparable results to the input tests.

31.6 Tips for Achieving Optimal MIDI Performance

In order to help users achieve optimal MIDI performance with Live, we have provided a list of recommended practices and program settings.

- Use the lowest possible buffer sizes available on your audio hardware, thereby keeping latency to a minimum. Audio buffer controls are found in the Audio tab of Live's Preferences, and vary depending on the type of hardware you're using. For more information, see the Lesson "Setting Up Audio I/O."
- Use a high quality MIDI interface with the most current drivers in order to ensure that MIDI timestamps are generated and processed as accurately as possible.
- Do *not* enable track monitoring if you are recording MIDI while listening directly to a hardware device such as an external synthesizer (as opposed to listening to the device's audio through Live via the External Instrument device). Likewise, disable track monitoring when recording MIDI data that is generated by another MIDI device (such as a drum machine). When monitoring is enabled, Live adds latency to compensate for playthrough jitter. Therefore, it is important to only enable monitoring when actually playing through.
- The DirectMusic architecture on Windows allows outgoing MIDI events to be scheduled by the operating system rather than scheduled by Live alone, so performance may differ depending on whether or not you're using MME or DirectMusic mode. If you experience timing issues, we recommend switching to the other mode. This is set in the [MIDI Ports list](#) in the MIDI/Sync Preferences.

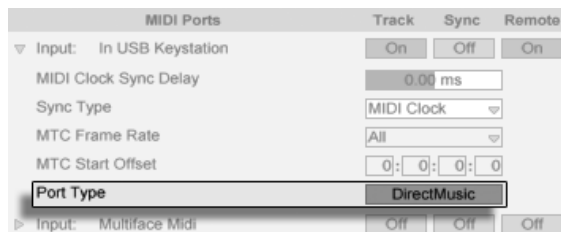

Selecting the MIDI Port Type (Windows).

31.7 Summary and Conclusions

Ableton wrote this paper in order to help users understand a variety of related topics:

- the inherent problems in computer-based MIDI systems;
- our approach to solving these problems in Live;
- additional variables that we cannot account for.

As mentioned before, the best way to solve MIDI timing issues in your studio is to use the highest-quality hardware components available. For users of such components, all software MIDI systems should perform with no noticeable issues. For users with less-than-optimal hardware, however, Live still offers an additional degree of accuracy by minimizing jitter, but at the expense of a small amount of additional latency.

We encourage you to refer to this paper if you have any questions about Live's approach to MIDI timing, but we also encourage you to [contact us](mailto:contact@ableton.com)¹ if you have additional questions or concerns that we haven't addressed.



¹contact@ableton.com

Chapter 32



Live Keyboard Shortcuts





32.1 Showing and Hiding Views

	Windows	Macintosh
Toggle Full Screen Mode	F11	Ctrl F11
Toggle Session/Arrangement View		
Toggle Track/Clip View	or F12	or Ctrl F12
Hide/Show Detail View	Ctrl Alt L or F12	Alt L or Ctrl F12
Hide/Show Info View	?	?
Hide/Show Browser	Ctrl Alt B	B
Hide/Show Overview	Ctrl Alt O	O
Hide/Show In/Out	Ctrl Alt I	I
Hide/Show Sends	Ctrl Alt S	S
Hide/Show Mixer	Ctrl Alt M	M
Open the Preferences	Ctrl ,	,





















	Windows	Macintosh
Close Window/Dialog		

32.2 Accessing Menus

Under Windows, you can access each menu by pressing  and the first letter of the menu ( F for “File,” for instance). While a menu is open, you can use:

-   to navigate the menu items;
-   to open the neighboring menu;
-  to choose a menu item.

32.3 Adjusting Values

	Windows	Macintosh
Increment/Decrement	 	 
Finer Resolution for Dragging		
Return to Default		
Type in Value	 .. 	 .. 
Go to Next Field (Bar.beat.16th)	 	 
Abort Value Entry		
Confirm Value Entry		

32.4 Browsing

In addition to the shortcuts shown here, [editing shortcuts](#) can also be used in the Browser.

	Windows	Macintosh
Scroll Up/Down	↓ ↑	↓ ↑
Open/Close Folders	← →	← →
Set Selected Folder as Browser Root	Return	Return
Load Selected Item from Browser	Return or Double-Click	Return or Double-Click
Preview Selected File	⏏ Return	⏏ Return
Activate Browser Search Mode	Ctrl ⏏ F	⌘ ⏏ F
Jump to Search Results	↓	↓

32.5 Transport

	Windows	Macintosh
Play from Start Marker/Stop	Space	Space
Continue Play from Stop Point	⏏ Space	⏏ Space
Play Arrangement View Selection	Ctrl Space	Alt ⌘ Space
Record	F9	F9
Back to Arrangement	F10	F10
Activate/Deactivate Track 1..8	F1 .. F8	F1 .. F8

32.6 Editing

	Windows	Macintosh
Cut	Ctrl X	⌘ X
Copy	Ctrl C	⌘ C
Paste	Ctrl V	⌘ V
Duplicate	Ctrl D	⌘ D
Delete	Delete	⬅
Undo	Ctrl Z	⌘ Z
Redo	Ctrl Y	⌘ ⇧ Z
Rename	Ctrl R	⌘ R
Select All	Ctrl A	⌘ A



























By holding down an additional modifier key, some of the above commands can also be applied to:

	Windows	Macintosh
Clips and Slots Across all Tracks	⇧	⇧
Time Across all Tracks	⇧	⇧
The Selected Part of the Envelope	Alt	Alt ⌘

⇧ can be used to move from one track or scene to another while renaming.





































32.7 Loop Brace and Start/End Markers

The loop brace and start/end markers must first be selected before any of the following commands will apply to them.

	Windows	Macintosh
Move Start Marker to Position	 Click	 Click
Nudge Loop Left/Right	 	 
Move Loop By Loop Length	 	 
Double/Halve Loop Length	Ctrl  	   
Shorten/Lengthen Loop	Ctrl  	   
Select Material in Loop	Click Loop Brace or Ctrl  L	Click Loop Brace or    L

32.8 Session View Commands

See also the [editing commands](#).

	Windows	Macintosh
Launch Selected Clip/Slot		
Select Neighbouring Clip/Slot	Arrow Keys	Arrow Keys
Select all Clips/Slots	Ctrl 	  
Copy Clips	Ctrl 	Alt 
Add/Remove Stop Button	Ctrl 	  
Insert MIDI clip	Ctrl   or Double-Click Slot	    or Double-Click Slot
Insert Scene	Ctrl 	  
Insert Captured Scene	Ctrl  	   
Move Nonadjacent Scenes Without Collapsing	Ctrl  	   
Drop Browser Clips as a Scene	Ctrl	 

32.9 Arrangement View Commands

The shortcuts for [zooming](#), [snapping/drawing](#) and [loop/region settings](#) also work in the Arrangement View. See also the [editing commands](#).

	Windows	Macintosh
Split Clip at Selection	Ctrl E	⌘ E
Consolidate Selection into Clip	Ctrl J	⌘ J
Create Fade/Crossfade	Ctrl Alt F	⌘ Alt F
Loop Selection	Ctrl L	⌘ L
Insert Silence	Ctrl I	⌘ I
Pan Left/Right of Selection	Ctrl Alt	⌘ Alt
Unfold all Tracks	Alt Unfold button	Alt Unfold button
Scroll Display to Follow Playback	Ctrl F	⌘ F

32.10 Commands for Tracks

See also the [editing commands](#).

	Windows	Macintosh
Insert Audio Track	Ctrl T	⌘ T
Insert MIDI Track	⇧ Ctrl T	⇧ ⌘ T
Insert Return Track	Ctrl Alt T	⌘ Alt T
Rename Selected Track	Ctrl R	⌘ R
While Renaming, Go to next Track	→	→
Group Selected Tracks	Ctrl G	⌘ G
Ungroup Tracks	Ctrl ⇧ G	⌘ ⇧ G
Show Grouped Tracks	+	+
Hide Grouped Tracks	-	-
Move Nonadjacent Tracks Without Collapsing	Ctrl + arrow keys	⌘ + arrow keys
Arm/Solo Multiple Tracks	Ctrl Click	⌘ Click
Add Device from Browser	Double-Click	Double-Click

32.11 Commands for Breakpoint Envelopes

The shortcuts for [zooming](#), [snapping/drawing](#) and [loop/region settings](#) also work in the Envelope Editor and Arrangement View. See also the [editing commands](#).

	Windows	Macintosh
Finer Resolution for Dragging	Ctrl	⌘
Enable Dragging Over Breakpoints	⇧	⇧

32.12 Key/MIDI Map Mode and the Computer MIDI Keyboard

	Windows	Macintosh
Toggle MIDI Map Mode	Ctrl M	⌘ M
Toggle Key Map Mode	Ctrl K	⌘ K
Computer MIDI Keyboard	Ctrl ↑ K	⌘ ↑ K

32.13 Zooming, Display and Selections

	Windows	Macintosh
Zoom In	+	+
Zoom Out	-	-
Drag/Click to Append to a Selection	⇧	⇧
Click to Add Adjacent Clips/Tracks/Scenes to Multi-Selection	⇧	⇧
Click to Add Nonadjacent Clips/Tracks/Scenes to a Multi-Selection	Ctrl	⌘
Follow (Auto-Scroll)	Ctrl F	⌘ F
Pan Left/Right of Selection	Ctrl Alt	⌘ Alt ⇐⇒

32.14 Clip View Sample Display

The shortcuts for [zooming](#) and [loop/region settings](#) also work in the Sample Display.

	Windows	Macintosh
Quantize	Ctrl U	⌘ U
Quantize Settings...	⏏ Ctrl U	⏏ ⌘ U
Move Selected Warp Marker	← →	← →
Select Warp Marker	Ctrl ← →	⌘ ← →
Scroll Display to Follow Playback	Ctrl F	⌘ F
Move Clip Region with Start Marker	⏏ ← →	⏏ ← →

32.15 Clip View MIDI Editor

The shortcuts for [zooming](#), [snapping/drawing](#) and [loop/region settings](#) also work in the MIDI Editor.

	Windows	Macintosh
Quantize	Ctrl U	⌘ U
Quantize Settings...	⏏ Ctrl U	⏏ ⌘ U
Scroll Editor Vertically	↓ Page ↑ Page	↓ Page ↑ Page
Scroll Editor Horizontally	Ctrl ↓ Page ↑ Page	⌘ ↓ Page ↑ Page
Copy Note	Ctrl Drag	Alt ⌘ Drag
Change Velocity From Note Editor	Alt Drag	⌘ Drag
Add/Delete Note in Edit Mode	Double-Click	Double-Click
Move Insert Mark to Beginning	Home	home
Move Insert Mark to End	End	end
Scroll Display to Follow Playback	Ctrl F	⌘ F
Move Clip Region with Start Marker	⏏ ← →	⏏ ← →

32.16 Grid Snapping and Drawing

	Windows	Macintosh
Toggle Draw Mode	Ctrl B	⌘ B
Narrow Grid	Ctrl 1	⌘ 1
Widen Grid	Ctrl 2	⌘ 2
Triplet Grid	Ctrl 3	⌘ 3
Snap to Grid	Ctrl 4	⌘ 4
Fixed/Zoom-Adaptive Grid	Ctrl 5	⌘ 5
Bypass Snapping While Dragging	Alt	⌘

32.17 Global Quantization

	Windows	Macintosh
Sixteenth-Note Quantization	Ctrl 6	⌘ 6
Eighth-Note Quantization	Ctrl 7	⌘ 7
Quarter-Note Quantization	Ctrl 8	⌘ 8
1-Bar Quantization	Ctrl 9	⌘ 9
Quantization Off	Ctrl 0	⌘ 0



32.18 Working with Sets and the Program

	Windows	Macintosh
New Live Set	Ctrl N	⌘ N
Open Live Set	Ctrl O	⌘ O
Close Live Set	Ctrl W	⌘ W
Save Live Set	Ctrl S	⌘ S
Save Live Set As...	⌘ Ctrl S	⌘ ⌘ S
Quit Live	Ctrl Q	⌘ Q
Hide Live		⌘ H
Export Audio/Video	Ctrl ⌘ R	⌘ ⌘ ⌘ R
Export MIDI file	Ctrl ⌘ E	⌘ ⌘ ⌘ E

32.19 Working with Plug-Ins and Devices

	Windows	Macintosh
Show/Hide Plug-In Windows	Ctrl Alt P	⌘ Alt ⌘ P
Open Second/Multiple Windows with Plug-In Edit Button	Ctrl	⌘
Open Mac Keystroke Plug-In Window with Plug-In Edit Button		⌘
Group/Ungroup Devices	Ctrl G	⌘ G
Activate/Deactivate All Devices in Group	Alt Device Activator	Alt ⌘ Device Activator
Click to Append Devices to a Selected Device	⌘	⌘
Load Selected Device From Browser	Return or Double-Click	Return or Double-Click

32.20 Using the Context Menu

A context menu is available in Live for quick access to many commonly used menu items. To access the context menu,  (PC) /   (Mac) on the part of the interface where you would like to execute a particular command. It is worth noting that Live's context menu may sometimes contain applicable settings from the Preferences. You should change these options with care, as they will affect not only the currently selected item but the general settings of the program.

Some commands *only* appear in the context menu. Among these are: the Create Folder, Analyze Audio, Search In Folder, Close All Folders and Refresh commands from the **Browser**; the special grid marker commands for directing **Auto-Warp**; detailed options for zoom-adaptive and fixed **grid line width**; and copying and pasting for **Operator's** envelopes and oscillators.

Index

- A**
- Ableton
 - e-mail addresses
 - sales 11
 - technical support 11
 - web addresses
 - FAQs 482
 - tutorials 482
 - webshop 11
 - Adaptive Grid options 85
 - Add/Remove Stop Button command 95
 - agr files see groove feature
 - Analog 351
 - amplifiers 357
 - architecture and interface 352
 - envelopes 358
 - filters 356
 - global parameters 360
 - LFOs 359
 - noise generator 355
 - oscillators 353
 - analysis files 43
 - storing clip settings in 112
 - analysis of files
 - batch processing 44
 - Analyze Audio command 44
 - APC40 466
 - Arm Recording button 187, 199
 - Arpeggiator effect 340
 - and grooves 342
 - Arrangement see Arrangement View
 - Arrangement Overview 74
 - Arrangement Position fields 76
 - Arrangement View 73
 - and copying to Session 97
 - and Session View 14
 - grid snapping 85
 - insert marker 75
 - looping in the 80
 - navigation 74
 - recording new clips in the 200
 - scrub area 75
 - Arrangement View selector 14
 - asd files see analysis files
 - audio clips see clips
 - audio effects see devices
 - Audio Fact Sheet 489
 - neutral operations 490
 - non-neutral operations 495

- testing and methodology489
 - tips498
 - audio files see samples
 - audio interface setup see Audio Preferences, see routing
 - Audio Preferences7
 - audio tracks see tracks
 - Audio Units Plug-ins, using see devices
 - authorization see copy protection
 - authorizing Live
 - more than once11
 - Auto Filter effect277
 - Auto Pan effect279
 - Auto Select235
 - Auto-Hide Plug-In Windows preference 220
 - Auto-Open Plug-In Windows preference 220
 - Auto-Warp126
 - Auto-Warp Long Samples preference .. 120
 - Automatic Rescan on Each Search35
 - automation26, 251
 - and grid lines255
 - drawing254
 - editing255
 - overriding/reactivating252
 - recording251
 - Automation Control chooser254
- B**
- Back to Arrangement button ... 16, 96, 252
 - Beat Repeat effect280
 - beat-time ruler
 - and Arrangement editing74
 - and editing envelopes267
 - and editing MIDI137
 - in the MIDI Editor138
 - Beats Mode131
 - Bit Depth preference207
 - bookmarks34
 - breakpoint envelopes . see automation, see clip envelopes
 - Browser see File Browser, see Live Device Browser, see Plug-In Device Browser
 - browsing files31
- C**
- Capture and Insert Scene command95
 - Check for Updates command1
 - Chord effect344
 - Chorus effect282
 - Clip Activator switch102
 - Clip box100
 - Clip Color chooser102
 - Clip Envelope Control chooser259
 - Clip Envelope Device chooser259
 - clip envelopes26, 258
 - and changing note pitch261
 - and changing note volume262
 - as LFOs269
 - changing clips for263
 - creating long loops with268
 - for MIDI controls265
 - general editing of258
 - imposing rhythm with269
 - loop/region settings for266
 - mixer control modulation with264
 - scrambling beats with262
 - unlinking from clips267
 - using for fade-outs266
 - Clip Fade switch113

- Clip Gain slider 111
- Clip Groove chooser 103
- Clip Launch button 90
- Clip Name field 102
- Clip Nudge buttons 104
- Clip Overview 99
 - for zooming/scrolling 106
- Clip Quantization chooser 157
- Clip Record button 25, 202
- Clip Signature fields 103
- Clip Stop button 90
 - adding/removing 95
- Clip Update Rate preference 117
- Clip View 98
 - and playing the Arrangement 76
 - and remote control mapping 463
 - scrub area 108
- Clip View boxes selector 101, 136, 155, 258
- clips 14
 - adding fades to 82, 113
 - arranging/editing 81
 - as templates 263
 - audio clips 17
 - clip multi-selections 99
 - crossfading 82
 - deactivating/muting 102
 - editing MIDI notes/velocities 135
 - importing from files 39
 - in Arrangement View 81
 - in audio/MIDI tracks 17
 - in Session View 90
 - Live Clips 51
 - MIDI clips 19
 - renaming 102
 - reversing 114
 - saving samples on export 68
 - saving settings for 112
 - setting properties of 98
- Close All Folders command 33
- Collect Samples on Export 68
- Collision 363
 - architecture and interface 363
 - Global section 372
 - LFOs 370
 - Mallet section 364
 - MIDI tab 371
 - Noise section 365
 - Resonators 366
 - sound design tips 373
- color scheme see Skin preference
- Complete Fragmentary Bar command ... 79
- Complex Mode 133
- Complex Pro Mode 133
- compressed audio files see samples
- Compressor effect 283
 - and sidechain 286
 - tips 287
- Computer MIDI Keyboard button 168
- Computer MIDI Keyboard option 168
- Consolidate command 87
- context menu 519
- Control chooser ... see Automation Control
 - chooser, see Clip Envelope Control
 - chooser
- control surfaces
 - and takeover mode 458
 - instant mappings for 455
 - locking to devices 456
 - manual setup 457
 - natively supported 454
- copy protection 10
- Corpus effect 289

- count-in for recording206
- Count-In preference 206
- CPU 483
- CPU Load meter 484
- CPU Preferences 7
- Create Analysis Files preference44
- Create Folder command 40
- Cropping
 - audio clips 115
 - MIDI clips 148
- crossfader22, 192
 - and remote control 194
 - automating the 195
- Cue Out chooser 196
- cue points see locators
- cueing 195
- Cut Time command
 - in the Arrangement86
 - in the MIDI Editor 144
- D**
- Decoding and Web Cache preferences ..42
- Delay Compensation option 227
- Delete All Time Signature Changes command 78
- Delete Automation command252
- Delete command
 - and devices 213
 - and envelopes 260
 - and tracks 190
 - in the Browser 40
- Delete Fragmentary Bar Time command 79
- Delete Locator button77
- Delete Locator command 77
- Delete Time command
 - in the Arrangement86
 - in the MIDI Editor 144
- in the Arrangement86
- in the MIDI Editor 144
- Delete Time Signature Change command 78
- Demo Sets 13
- Detune field 111
- Device Activator switch 213
- Device chooser .. see Clip Envelope Device chooser, see Fades/Device chooser
- devices 20
 - compensating for delays 227
 - presets 214
 - the Live audio effects 277
 - the Live instruments 351
 - the Live MIDI effects 340
 - the Max Audio Effect 447
 - the Max Instrument 447
 - the Max MIDI Effect 447
 - using Audio Units Plug-ins 226
 - using Live devices 211
 - using plug-in devices 217
 - using VST Plug-ins 223
- dither 46
- Double/Halve Original BPM buttons ... 116, 124
- Draw Mode 254
 - and drawing MIDI 136
 - with clip envelopes 261
- Draw Mode command 254
- Drum Machines 374
- Drum Racks 241
 - Pad View 243
- Duplicate Time command
 - in the Arrangement86
 - in the MIDI Editor 144
- Dynamic Tube effect 293

- E**
- Edit menu commands
 - and automation 252, 256
 - and exporting 45
 - and MIDI notes 141
 - and return tracks 192
 - and scenes 92
 - and tracks 189
 - in the Browser 39
 - with Clip Stop buttons 95
 - with clips 102
 - with devices 213
 - with scenes 95
 - Edit switch 111
 - effects see devices
 - EIC see Essential Instrument Collection
 - Electric 375
 - architecture and interface 376
 - damper section 377
 - fork section 377
 - global section 378
 - mallet section 376
 - pickup section 378
 - Envelope Editor 100, 258
 - envelopes see automation, see clip envelopes
 - Envelopes box 100, 258
 - EQ Eight effect 294
 - EQ Three effect 296
 - Erosion effect 297
 - Essential Instrument Collection 444
 - Exclusive Arm/Solo preference 187
 - Export Audio/Video 44
 - Export MIDI Clip command 50
 - exporting audio ... see Export Audio/Video
 - exporting video ... see Export Audio/Video
 - External Audio Effect 298
 - and real-time freezing 485
 - and real-time rendering 47
 - External Instrument 379
 - and multi-timbral plug-ins 181
 - and real-time freezing 485
 - and real-time rendering 47
 - and ReWire devices 171
 - external sync see MIDI synchronization
- F**
- Fades/Device chooser 82, 253
 - FAQs see Ableton
 - File Browser 31
 - opening Sets with the 13
 - file management see Manage Files command
 - File Manager 60
 - File Type preference 207
 - File/Folder Preferences 7
 - and VST Plug-ins 223
 - Filter Delay effect 299
 - Fixed Grid command 85
 - Fixed Grid options 85
 - FLAC files see samples
 - Flanger effect 301
 - Fold button 140
 - Follow Actions 158
 - Follow command 75, 106
 - Follow switch 75, 106, 122, 139
 - fragmentary bars 79
 - Freeze Track command 485
 - Frequency Shifter effect 302
 - tips 304

- Full Screen Mode 8
- G**
- Gate effect 305
- Gate Mode 156
- Global Quantization chooser 25
- and Session recording 201
- Grain Delay effect 306
- Grain Flux field 132
- Grain Size field 132
- Grain Size knob 132
- grid
- and Arrangement editing 85
- and envelope drawing 255
- and MIDI editing 141
- and time signature markers 79
- in editing clip envelopes 268
- working with the 85
- groove feature 103, 149
- Groove Pool 150
- group slots 91
- Group Tracks see tracks
- H**
- hard disk see CPU
- Hard Disk Overload indicator 487
- High Quality switch 112
- hot-swapping 40
- and device presets 215
- and grooves 149
- and Impulse 382
- and Simplr 425
- I**
- I/O see routing
- importing files 39
- importing projects 64
- Impulse instrument 381
- and individual outputs 384
- and MIDI 382
- filter 383
- global controls 384
- Link button 382
- pan and volume 384
- sample slots and controls 382
- saturator and envelope 383
- Start, Tune and Stretch 383
- Info View 6
- insert
- effect 211
- instrument 211
- plug-ins 217
- track 189
- Insert Audio Track command 189
- insert marker 75
- Insert MIDI Clip command 135
- Insert MIDI Track command 189
- Insert Return Track command 192
- Insert Scene command 95
- Insert Silence command 87
- in the MIDI Editor 144
- Insert Time Signature Change command 78
- instruments see devices
- K**
- Key Map Mode switch 464
- Key/MIDI In Indicator 170
- Key/MIDI Out Indicator 170
- keyboard shortcuts 508

- L**
- Language preference 6
 - latency
 - and the External Audio Effect 298
 - Latin Percussion 384
 - Launch box 100, 155
 - Launch Modes 156
 - Legato Mode 158
 - lessons 5
 - Library 29, 61
 - migrating from older versions 64
 - Library Location preference 63
 - Library Preferences 7
 - Limiter effect 308
 - Link/Unlink Envelope switch 267
 - Live Clips 51
 - Live Device Browser 8, 211
 - Live Packs 61
 - Live Projects 56
 - and device presets 60
 - and Live Sets 57
 - packing 70
 - Live Sets 13, 52
 - changing sample references 55
 - downloading 451
 - exporting and importing 52
 - saving the default template 54
 - uploading 449
 - locators 77
 - Lock Envelopes command 256
 - Lock Envelopes switch 256
 - Look/Feel Preferences 6
 - loop brace
 - in the Arrangement 80
 - with clips 109
 - Loop Selection command 80
 - Loop Start/Punch-In Position fields 80
 - Loop switch
 - Clip View 108, 267, 268
 - Control Bar 80
 - with MIDI clips 140
 - Loop To Next Locator command 78
 - Loop/Punch Region Length fields 80
 - Loop/Region controls 107, 109
 - and clip envelopes 267
 - with MIDI clips 140
 - Loop/Warp Short Samples preference .. 120
 - Looper effect 309
 - feedback routing 313
- M**
- Macro Controls 230
 - Macro Map Mode 247
 - Manage Files command
 - and changing sample references 55
 - and collecting external samples . 67, 68
 - and finding unused samples 69
 - and importing projects 64
 - and locating missing samples 64
 - and packing Live Projects 70
 - and project management 60
 - managing files see File Manager
 - Mapping Browser 459
 - mapping to MIDI/keys 27, 453
 - and recording 207
 - Master Out chooser 196
 - Master track 191
 - Max for Live 447
 - Maximum Cache Size preference 42
 - Metronome switch 205

- MIDI
 - exporting 50
 - quantizing 144, 206
 - sending bank/program changes ... 116
 - MIDI clips see clips
 - MIDI controllers see control surfaces
 - MIDI Editor 100, 135
 - and drawing MIDI 136
 - and drawing velocities 146
 - and grid lines 141, 143
 - and recording MIDI 203
 - and step recording 204
 - creating and editing notes 141
 - editing velocities 145
 - loop/region settings for 140
 - MIDI note stretch 147
 - navigation 137
 - note-off velocity 147
 - rearranging notes in 141
 - MIDI effects see devices
 - MIDI Fact Sheet 500
 - MIDI files 19
 - and time signature changes 80
 - MIDI interface setup see routing
 - MIDI Map Mode switch 459
 - MIDI Ports list 167
 - MIDI Preferences 7
 - MIDI synchronization 477
 - MIDI Timecode Frame Rate preference 479
 - MIDI Timecode Start Offset preference 479
 - MIDI Track In Indicator 170
 - MIDI Track Out Indicator 170
 - MIDI tracks see tracks
 - Minimum Free Space preference 42
 - mixer 22, 185
 - Mixer Section selector 186
 - modulation see clip envelopes
 - monitor mix 192
 - monitoring 165
 - monitoring through Live see Audio Preferences
 - MP3 files see samples
 - Multiband Dynamics effect 314
 - interface and controls 316
 - theory 315
 - tips 318
 - Multicore/Multiprocessor Support 483
 - Multiple Plug-In Windows preference .. 220
 - Multisampling 409
 - muting see Track Activator switch
 - clips 102
- ## N
- Narrow Grid command 85
 - New command 52
 - Next Locator button 77
 - normalizing rendered audio 46
 - Note Editor 136
 - Note Length effect 345
 - Notes box 100
 - Nudge buttons see Clip Nudge buttons
- ## O
- offline clips 64
 - Ogg files see samples
 - Open/Open Recent command 52
 - Operator instrument 386
 - algorithms 387
 - aliasing and Tone 391
 - AMS files 389
 - and CPU resources 397

- envelopes 393
 - filter 395
 - Glide and Spread 397
 - global controls 396
 - layout 387
 - LFO 392
 - MIDI modulation 396
 - oscillators 388
 - parameter list 398
 - user waveforms 389
 - Orchestral Brass 407
 - Orchestral Percussion 407
 - Orchestral Strings 407
 - Orchestral Woodwinds 407
 - Original BPM field 116, 124
 - Overdrive effect 320
 - Overdub Switch 201, 203
 - Overdubbing 203
- P**
- packs see Live Packs
 - Pan control 187
 - Pan quick-chooser button see quick-chooser buttons
 - Parent Folder item 33
 - Paste Time command
 - in the Arrangement 86
 - in the MIDI Editor 144
 - pencil tool see Draw Mode
 - Phaser effect 321
 - Ping Pong Delay effect 322
 - Pitch Bend quick-chooser button see quick-chooser buttons
 - Pitch effect 346
 - Play button 75
 - plug-ins, using see devices
 - Plug-In Buffer Size preference 223
 - Plug-In Configure Mode 221
 - Plug-In Device Browser 218
 - Plug-In Device Browserselector 218
 - Plug-In Edit button 220
 - Plug-In Unfold button 219
 - pre-listening samples see previewing
 - Pre/Post switches 192
 - Preferences 6
 - and recording clips 207
 - Preserve chooser 131
 - presets 214
 - converting Sampler to Simplr 409
 - converting Simplr to Sampler 425
 - Defaults 216
 - for specific Live Projects 60
 - saving with samples 68
 - Preview switch 37, 137
 - Preview Tab 37
 - Preview Volume knob 205
 - previewing
 - in the Browser 37
 - in the MIDI Editor 137
 - Previous Locator button 77
 - processor see CPU
 - projects/project management see Live Projects
 - Punch-In/Out switches 201
- Q**
- quantization
 - command for audio 130
 - command for selected MIDI notes . 144
 - for clip launching 157

- for MIDI notes during recording ... 206
- Quantize menu command 130, 144
- quick-chooser buttons 259
- R**
- Racks 229
 - Auto Select option 235
 - Chain List 234
 - components 232
 - creating 231
 - Macro Controls 230, 247
 - mixing 248
 - routing tap points 175
 - zones 236
- RAM Mode switch 113
- Random effect 347
- Re-Pitch Mode 132
- Record button 96
- Record Quantization 206
- Record/Warp/Launch Preferences 7
- recording
 - and remote control 207
 - audio and MIDI 198
 - automation 251
 - overdubbing 200, 203
 - punch-in/punch-out 200
 - resampling the Master output 172
 - step recording 204
 - with count-in 206
- recording an Arrangement 96
- recording automation 251
- Redux effect 324
- registration see Ableton
- remote control .. see mapping to MIDI/keys
- Rename command
 - in the Browser 40
 - with clips 102
 - with locators 77
 - with plug-ins 225
 - with tracks 189
- Repeat Mode 156
- resampling 172, see recording
- Rescan Plug-Ins preference 218
- Resonators effect 325
- return tracks 22, 191
- Reverb effect 326
 - Diffusion Network 328
 - Early Reflections 327
 - Global Settings 327
 - Input Processing 326
 - Output 328
- Reverse button 114
- ReWire 480
 - Live as master 170
 - Live as slave 481
 - recording see recording
 - tutorials see Ableton
- REX Mode 133
- ring modulation 302
- routing 24, 164
 - and computer keys 168
 - and external audio in/out 166
 - and external MIDI in/out 167
 - and instruments 178
 - and layering 183
 - and post-effects recording 176
 - and recording MIDI as audio 177
 - and ReWire 170
 - and sidechain inputs 182
 - between tracks 172
 - for creating submixes 178

- with external synthesizers 169
- S**
- sales see Ableton
- Sample box 100
- sample collections .see Essential Instrument Collection
- Sample Display 100, 106
- Sample Editor preference 56
- Sampler instrument 409
 - Filter/Global tab 419
 - importing samples 410
 - Key Zones 413
 - MIDI tab 421
 - Modulation tab 420
 - Pitch/Osc Tab 418
 - Sample Select Zones 414
 - Sample tab 415
 - Velocity Zones 414
 - Zone tab 412
- samples 17
 - collecting 67
 - destructive editing 56, 111
 - finding unused 69
 - high-quality interpolation 112
 - offline/missing 64
 - played from RAM Mode 113
 - replacing 55
 - reversing 114
 - saving with clip settings 112
 - time-warping 120
 - working with 42
- Saturator effect 329
- Save a Copy command 52
- Save As command 52
- Save command 52
- Save Current Set as Default button 54
- Save Default Clip button 43, 112
- Save Live Set to Web command 52, 449
- Scale effect 348
- Scene Launch button 91
- Scene Select field 463
- Scene Up/Down buttons 207, 463
- scenes 15, 91
 - and MIDI/key mapping 463
 - editing 95
 - recording 202
- scrubbing playback
 - in the Arrangement View 75
 - in the Clip View 108
- Search button 34
- Search In Folder command 35
- searching in the File Browser 34
 - rescan 35
- Select Loop command 84
 - and clip envelopes 259
 - and exporting 45
- Select Next Scene on Launch option 92
- Select Next Scene on Launch preference 463
- Select on Launch preference 95
- Send controls 22, 192
- Session Drums 422
- Session View 89
 - and Arrangement View 14
 - clip grid 94
 - copying to Arrangement 97
 - recording an Arrangement 96
 - recording audio in 201
- Session View selector 14
- Set 1.1.1 Here command 127
- Set Locator button 77

- Set Locator command 77
 - Set Song Start Time Here command 78
 - sets see Live Sets
 - sharing Live Sets 449
 - shortcuts see keyboard shortcuts
 - Show/Hide Plug-In Windows command 220
 - shuffle see groove feature
 - Simple Delay effect 331
 - Simpler instrument 425
 - and CPU resources 429
 - envelope 427
 - filter 427
 - Glide and Spread 428
 - LFO 427
 - Multisample Mode 425
 - Pan 429
 - sample controls 426
 - Sample View 425
 - Transpose 428
 - Voices 428
 - Volume 429
 - Zoom 426
 - site or secondary licenses 11
 - Skin preference 6
 - slicing 245
 - Snap to Grid command 85
 - Solo in Place 195
 - Solo switch 187
 - Solo/Cue Mode switch 196
 - sound files see samples
 - Spectrum device 332
 - Split button 136
 - Split command 87
 - Start Recording on Scene Launch 202
 - start/end markers 107
 - step recording 204
 - Stop All Clips button 97
 - Stop button 75
 - swing see groove feature
 - Sync Delay preference 479
 - Sync In Indicator 169
 - Sync Out Indicator 169
 - synthesizer MIDI setup see routing
- ## T
- Takeover Mode preference 458
 - Tap Tempo button 119
 - with warping 129
 - technical support 11
 - tempo
 - and scene names 92, 96
 - automating 257
 - MIDI mapping ranges 257
 - nudging 119
 - setting 118
 - tapping 119
 - Tempo field 105, 118
 - Tempo Nudge buttons 119
 - Temporary Folder preference 207
 - Tension 430
 - architecture and interface 430
 - Body section 439
 - Damper section 436
 - Excitator section 431
 - Filter section 440
 - Global and Keyboard parameters .. 442
 - Pickup section 438
 - sound design tips 443
 - String section 434
 - Termination section 437
 - Vibrato section 435

- Texture Mode 132
 - Time Ruler Format option 479
 - time signature
 - and scene names 92, 96
 - time signature changes 78
 - Toggle Mode 156
 - Tones Mode 132
 - Track Activator switch 187
 - Track Delay control 197
 - Track Delays selector 197
 - track meter 187
 - Track Status field 93
 - Track title bar 189
 - Track View 209
 - tracks 15
 - activating 187
 - audio and MIDI in 17
 - automation in 253
 - compensating for device delays ... 197
 - devices in 209
 - exporting samples with 68
 - grouping 190
 - in Arrangement View 81
 - in Session View 91
 - inserting 189
 - mixer controls in 185
 - muting 187
 - numbering 189
 - renaming 189
 - resizing 189
 - return tracks 191
 - returns 22
 - the Master track 191
 - unfolding 82, 84, 253
 - Transient Envelopes 131
 - Transient Loop Mode 131
 - transport 75
 - Transpose quick-chooser button see quick-chooser buttons
 - Transposition knob 111
 - Trigger Mode 156
 - Triplet Grid command 85
 - tutorials see Ableton, see lessons
- ## U
- Undo command
 - and Arrangement editing 140
 - and automation editing 252
 - and recorded clips 201
 - and recording MIDI 206
 - Unfold Track button 82, 84, 253
 - Unfreeze Track command 485
 - unlocking the program see copy protection
 - updates .. see Check for Updates command
 - Upload/Download Browser 452
 - Use Audio Units preference 226
 - Use Plug-In Custom Folder 223
 - Use VST Plug-In System Folders 223
 - User Account/Licenses Preferences ... 7, 10
 - Utility effect 334
- ## V
- Variable Bit Rate files see samples
 - Velocity Amount field 157
 - Velocity Editor 136
 - Velocity effect 349
 - video 270
 - and warp markers 273
 - clip view 273
 - exporting 44
 - importing 270

- in the Arrangement View 271
- matching sound to video 274
- trimming tricks 275
- window 272
- View menu commands
 - Crossfader option 186
 - In/Out option 22, 164, 186
 - Mixer option 22, 186
 - Returns option 22, 186, 191
 - Sends option 22, 186
 - Track Delays option 186
- view selector buttons 8
- views, working with see View menu commands, see view selector buttons
- Vinyl Distortion effect 335
- Vocoder effect 336
 - tips 338
- Volume control 187
- Volume quick-chooser button see quick-chooser buttons
- VST Plug-ins, using see devices
- VST Plug-In Custom Folder button 223
- Warp Mode chooser 130
- Warp Modes 130
- Warp switch 105
- warping 120
 - longer pieces 126
 - manipulating grooves 125
 - multiple clips 129
 - odd-length loops 125
 - straight loops 124
 - tempo master/slave 121
 - uncut loops 124
- webshop see Ableton
- Widen Grid command 85

Z

- Zoom Display 6

W

- Warp ... BPM From Here command 129
- Warp As ...-Bar Loop command 128
- Warp From Here (Start At ...) command 129
- Warp From Here (Straight) command ... 129
- Warp From Here command 129
- Warp Markers 121
 - and transients 122
 - pseudo 122
 - saving 123
 - saving settings 112